

- Multiturn/ Cermet/ Industrial /sealed
- 5 terminal styles
- RoHS Compliant



3296 Square Trimming Potentiometer

Electrical Characteristics

Standard Resistance Range.....50 Ω~2M Ω
Resistance Tolerance.....± 10%
Absolute Minimum Resistance...≤ 1%R or 10 Ω
Contact Resistance Variation ...CRV≤3% or 5 Ω
Insulation Resistance.....R1≥1G Ω (100Vac)
Withstand Voltage.....640Vac

Effective Travel.....28 turns nom

Environmental Characteristics

(Power Rating) (315 volts max)
.....0.5W@70°C,0W@125°C
Temperature Range.....- 55°C~125 °C
Temperature Coefficient.....± 250ppm/°C
Temperature Variation ... - 55°C,30min,+125°C
.....30min、5cycles
..... $\Delta R \leq 5\%R, \Delta(Uab/Uac) \leq 5\%$
Vibration.....10~500Hz,0.75mm,6h,
..... $\Delta R \leq 5\%R, \Delta(Uab/Uac) \leq 7.5\%R$
Collision.....390m/s²,4000cycles, $\Delta R \leq 5\%R$
Electrical Endurance at 70°C..... 0.5W@70°C
.....1000h, $\Delta R \leq 10\%R, CRV \leq 3\%$ or 5 Ω
Rotational Life.....200cycles
..... $\Delta R \leq 10\%R, CRV \leq 3\%$ or 5 Ω

Physical Characteristics

Starting Torque.....≤35mN·m
Marking.....Resistance Tolerance
... (when no identification, it is of ± 10%)
.....Resistance Code、 Model
Standard Packaging...50pcs.per tube

RoHS Compliant

Common Dimensions

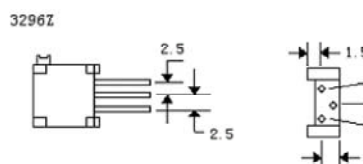
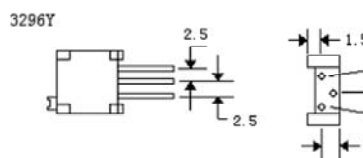
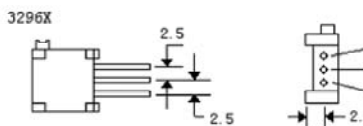
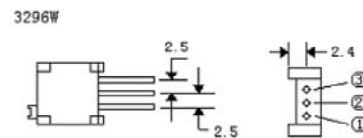
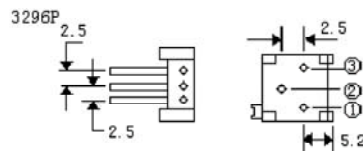
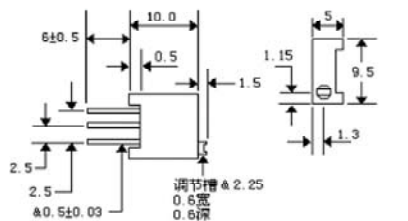

How To Order

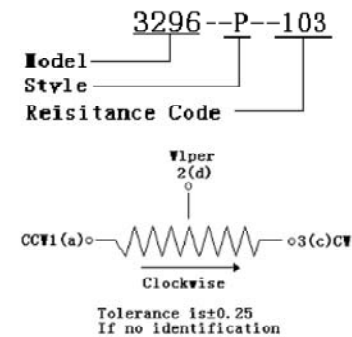

Standard Resistance Table

Resistance (Ohms)	Resistance Code
10	100
20	200
50	500
100	101
200	201
500	501
1,000	102
2,000	202
5,000	502
10,000	103
20,000	203
25,000	253
50,000	503
100,000	104
200,000	204
250,000	254
500,000	504
1,000,000	105
2,000,000	205