

# PESD5V0X1BQ; PESD5V0X1BT

Ultra low capacitance bidirectional ESD protection diodes

Rev. 01 — 30 October 2008

Product data sheet

## 1. Product profile

### 1.1 General description

Ultra low capacitance bidirectional ElectroStatic Discharge (ESD) protection diodes in small Surface-Mounted Device (SMD) plastic packages designed to protect one signal line from the damage caused by ESD and other transients.

The devices may also be used for unidirectional ESD protection of up to two signal lines.

Table 1. Product overview

Type number	Package		Package configuration
	NXP	JEDEC	
PESD5V0X1BQ	SOT663	-	ultra small and flat lead
PESD5V0X1BT	SOT23	TO-236AB	very small

### 1.2 Features

- Bidirectional ESD protection of one line
- Unidirectional ESD protection of up to two lines
- Ultra low diode capacitance:  $C_d = 0.9$  pF
- Very low leakage current:  $I_{RM} = 1$  nA
- ESD protection up to 9 kV
- IEC 61000-4-2; level 4 (ESD)
- AEC-Q101 qualified

### 1.3 Applications

- USB interfaces
- Antenna protection
- Radio Frequency (RF) protection
- 10/100/1000 Mbit/s Ethernet
- FireWire
- Asymmetric Digital Subscriber Line (ADSL)
- High-speed data lines
- Subscriber Identity Module (SIM) card protection
- Computers, peripherals and printers
- Cellular handsets and accessories
- Portable electronics
- Communication systems
- Audio and video equipment

## 1.4 Quick reference data

**Table 2. Quick reference data**

$T_{amb} = 25^{\circ}C$  unless otherwise specified.

Symbol	Parameter	Conditions	Min	Typ	Max	Unit	
<b>Per diode</b>							
$V_{RWM}$	reverse standoff voltage		-	-	5	V	
$C_d$	diode capacitance	$f = 1\text{ MHz}; V_R = 0\text{ V}$	[1]	-	0.9	1.3	pF
			[2]	-	2	2.6	pF

[1] Bidirectional configuration: measured from pin 1 to 2 or pin 2 to 1.

[2] Unidirectional configuration: measured from pin 1 to 3 or pin 2 to 3.

## 2. Pinning information

**Table 3. Pinning**

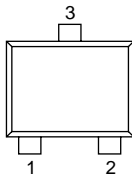
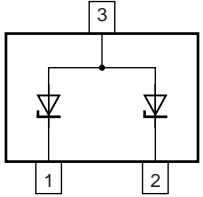
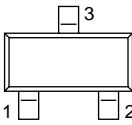
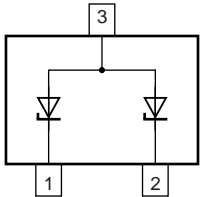
Pin	Description	Simplified outline	Graphic symbol
<b>PESD5V0X1BQ</b>			
1	cathode (diode 1)		 <p>006aaa154</p>
2	cathode (diode 2)		
3	common anode		
<b>PESD5V0X1BT</b>			
1	cathode (diode 1)		 <p>006aaa154</p>
2	cathode (diode 2)		
3	common anode		

## 3. Ordering information

**Table 4. Ordering information**

Type number	Package		
	Name	Description	Version
PESD5V0X1BQ	-	plastic surface-mounted package; 3 leads	SOT663
PESD5V0X1BT	-	plastic surface-mounted package; 3 leads	SOT23

## 4. Marking

**Table 5. Marking codes**

Type number	Marking code <sup>[1]</sup>
PESD5V0X1BQ	E6
PESD5V0X1BT	U3*

- [1] \* = -: made in Hong Kong  
 \* = p: made in Hong Kong  
 \* = t: made in Malaysia  
 \* = W: made in China

## 5. Limiting values

**Table 6. Limiting values**

*In accordance with the Absolute Maximum Rating System (IEC 60134).*

Symbol	Parameter	Conditions	Min	Max	Unit
<b>Per device</b>					
$T_j$	junction temperature		-	150	°C
$T_{amb}$	ambient temperature		-55	+150	°C
$T_{stg}$	storage temperature		-65	+150	°C

**Table 7. ESD maximum ratings**

*$T_{amb} = 25\text{ °C}$  unless otherwise specified.*

Symbol	Parameter	Conditions	Min	Max	Unit
<b>Per diode</b>					
$V_{ESD}$	electrostatic discharge voltage	IEC 61000-4-2 (contact discharge)	<sup>[1]</sup> -	9	kV
		MIL-STD-883 (human body model)	-	10	kV

- [1] Device stressed with ten non-repetitive ESD pulses.

**Table 8. ESD standards compliance**

Standard	Conditions
<b>Per diode</b>	
IEC 61000-4-2; level 4 (ESD)	> 8 kV (contact)
MIL-STD-883; class 3 (human body model)	> 4 kV

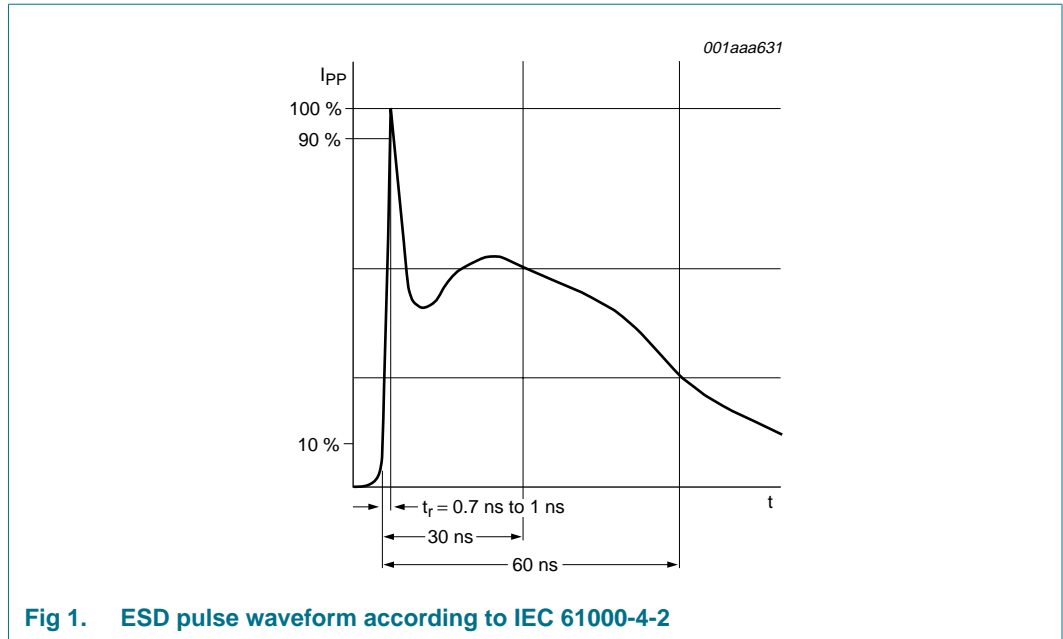

Fig 1. ESD pulse waveform according to IEC 61000-4-2

## 6. Characteristics

**Table 9. Characteristics**

*T<sub>amb</sub> = 25 °C unless otherwise specified.*

Symbol	Parameter	Conditions	Min	Typ	Max	Unit		
<b>Per diode</b>								
V <sub>RWM</sub>	reverse standoff voltage		-	-	5	V		
I <sub>RM</sub>	reverse leakage current	V <sub>RWM</sub> = 5 V	-	1	100	nA		
V <sub>BR</sub>	breakdown voltage	I <sub>R</sub> = 5 mA	5.8	7.5	9.5	V		
C <sub>d</sub>	diode capacitance	f = 1 MHz		V <sub>R</sub> = 0 V				
				[1]	-	0.9	1.3	pF
				[2]	-	2	2.6	pF
				V <sub>R</sub> = 5 V				
[1]	-	0.8	1.2	pF				
[2]	-	1.7	2.3	pF				
r <sub>dif</sub>	differential resistance	I <sub>R</sub> = 1 mA	-	-	100	Ω		

[1] Bidirectional configuration: measured from pin 1 to 2 or pin 2 to 1.

[2] Unidirectional configuration: measured from pin 1 to 3 or pin 2 to 3.

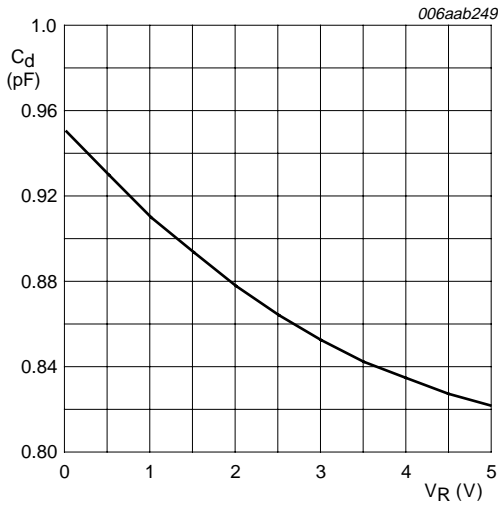

bidirectional configuration  
 $f = 1 \text{ MHz}; T_{\text{amb}} = 25 \text{ }^\circ\text{C}$

**Fig 2. Diode capacitance as a function of reverse voltage; typical values**

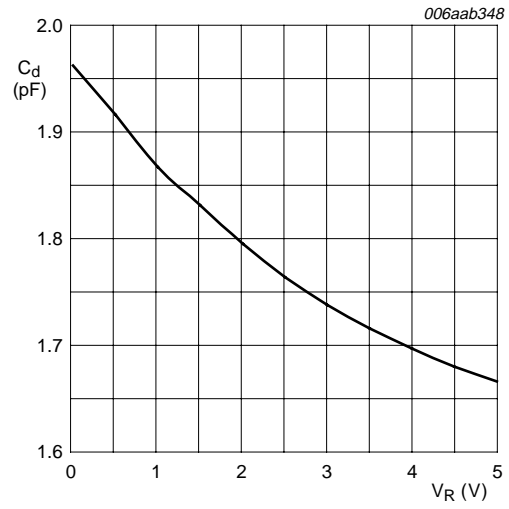

unidirectional configuration  
 $f = 1 \text{ MHz}; T_{\text{amb}} = 25 \text{ }^\circ\text{C}$

**Fig 3. Diode capacitance as a function of reverse voltage; typical values**

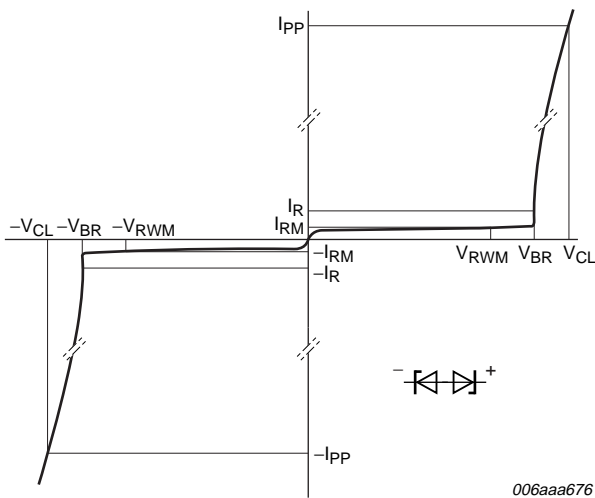

**Fig 4. V-I characteristics for a bidirectional ESD protection diode**

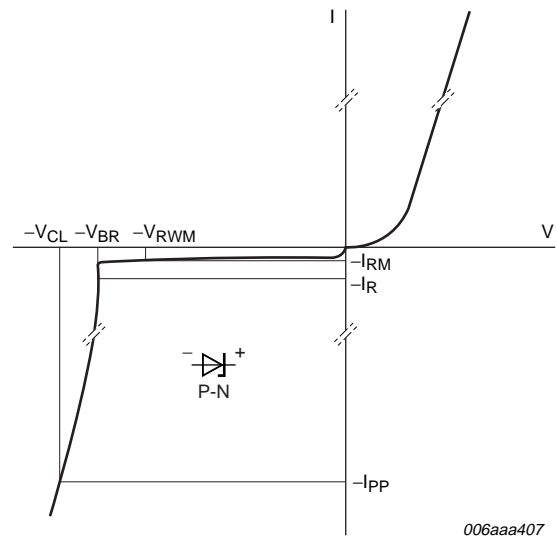

**Fig 5. V-I characteristics for a unidirectional ESD protection diode**

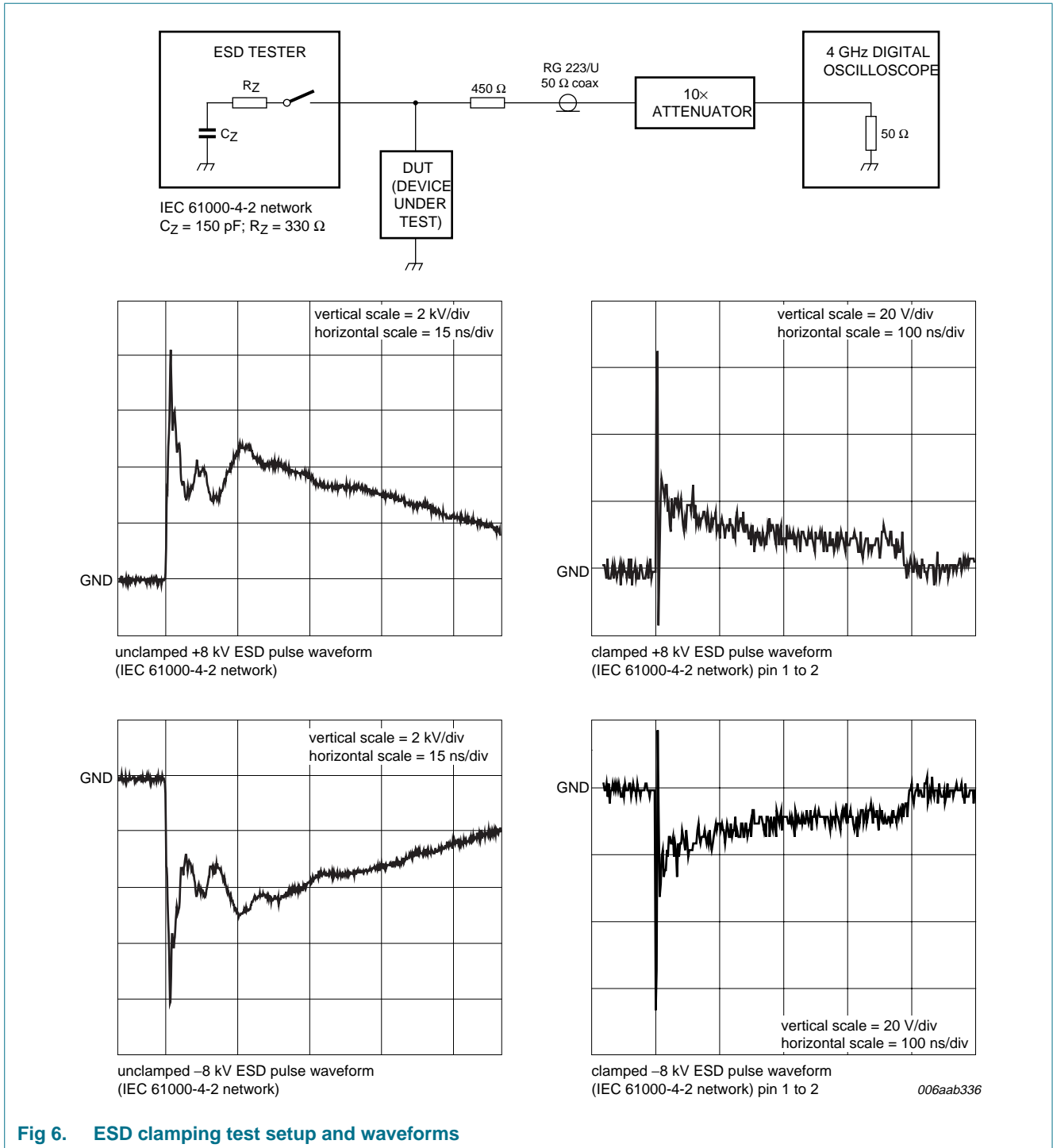
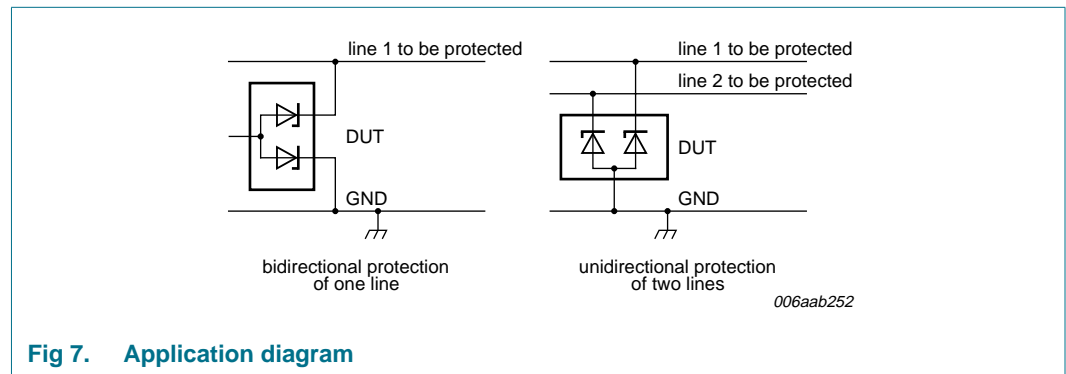

**Fig 6. ESD clamping test setup and waveforms**

## 7. Application information

PESD5V0X1BQ and PESD5V0X1BT are designed for the protection of one bidirectional data or signal line from the damage caused by ESD. The devices may be used on lines where the signal polarities are both, positive and negative with respect to ground.

PESD5V0X1BQ and PESD5V0X1BT may also be used for the protection of two unidirectional data or signal lines, which have positive signal polarities with respect to ground.



**Fig 7. Application diagram**

### Circuit board layout and protection device placement

Circuit board layout is critical for the suppression of ESD and Electrical Fast Transient (EFT). The following guidelines are recommended:

1. Place the device as close to the input terminal or connector as possible.
2. The path length between the device and the protected line should be minimized.
3. Keep parallel signal paths to a minimum.
4. Avoid running protected conductors in parallel with unprotected conductors.
5. Minimize all Printed-Circuit Board (PCB) conductive loops including power and ground loops.
6. Minimize the length of the transient return path to ground.
7. Avoid using shared transient return paths to a common ground point.
8. Ground planes should be used whenever possible. For multilayer PCBs, use ground vias.

## 8. Test information

### 8.1 Quality information

This product has been qualified in accordance with the Automotive Electronics Council (AEC) standard *Q101 - Stress test qualification for discrete semiconductors*, and is suitable for use in automotive applications.

## 9. Package outline

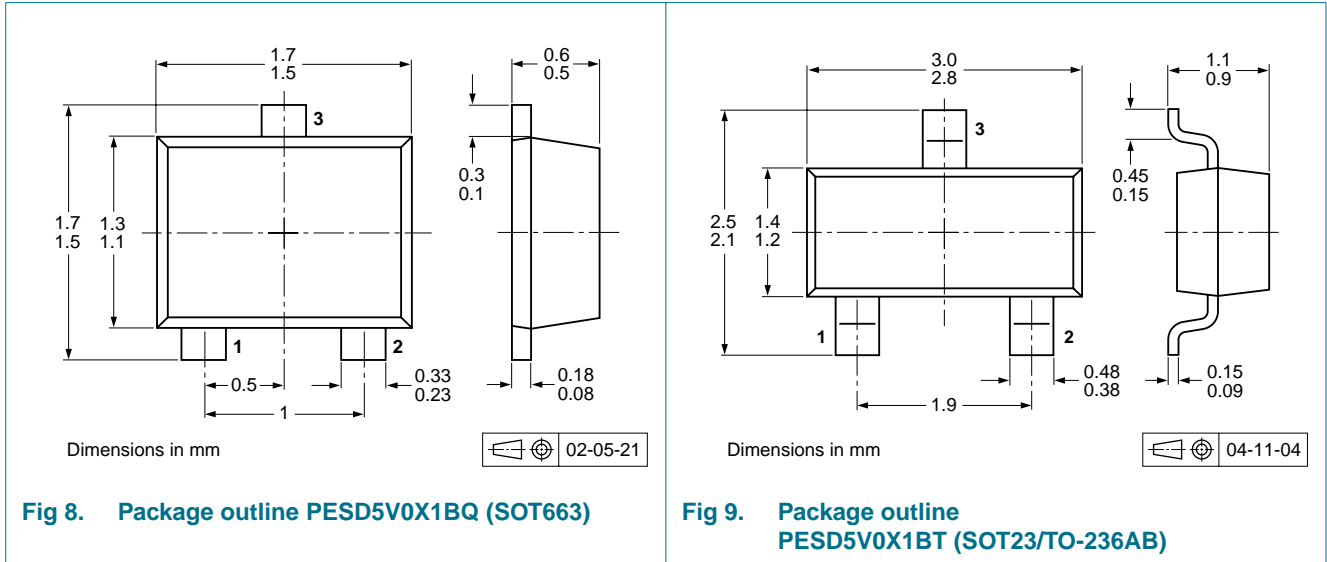

## 10. Packing information

**Table 10. Packing methods**

The indicated -xxx are the last three digits of the 12NC ordering code.<sup>[1]</sup>

Type number	Package	Description	Packing quantity			
			3000	4000	8000	10000
PESD5V0X1BQ	SOT663	2 mm pitch, 8 mm tape and reel	-	-	-315	-
		4 mm pitch, 8 mm tape and reel	-	-115	-	-
PESD5V0X1BT	SOT23	4 mm pitch, 8 mm tape and reel	-215	-	-	-235

[1] For further information and the availability of packing methods, see [Section 14](#).



## 11. Soldering

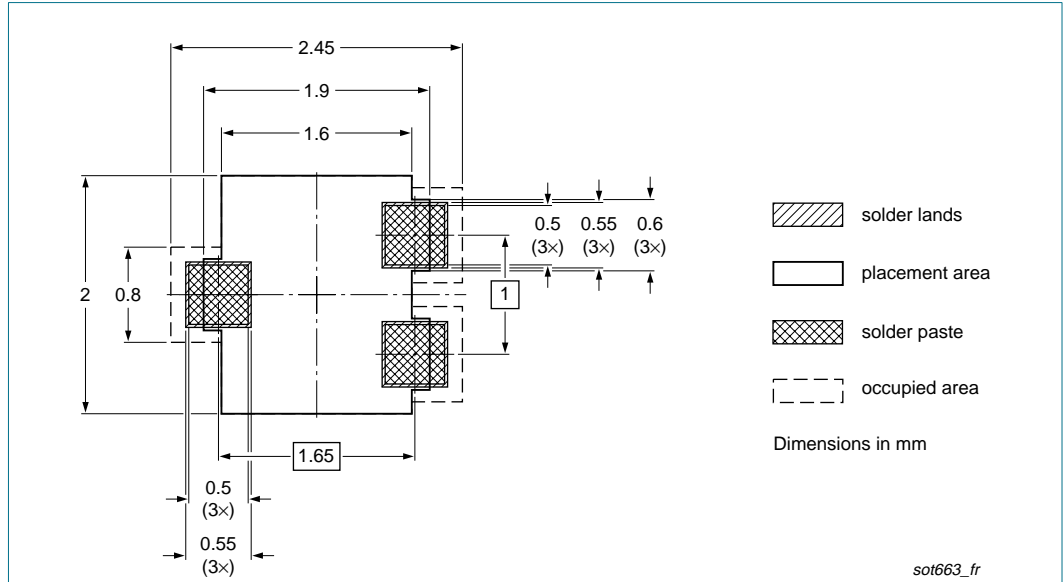

Reflow soldering is the only recommended soldering method.

**Fig 10. Reflow soldering footprint PESD5V0X1BQ (SOT663)**

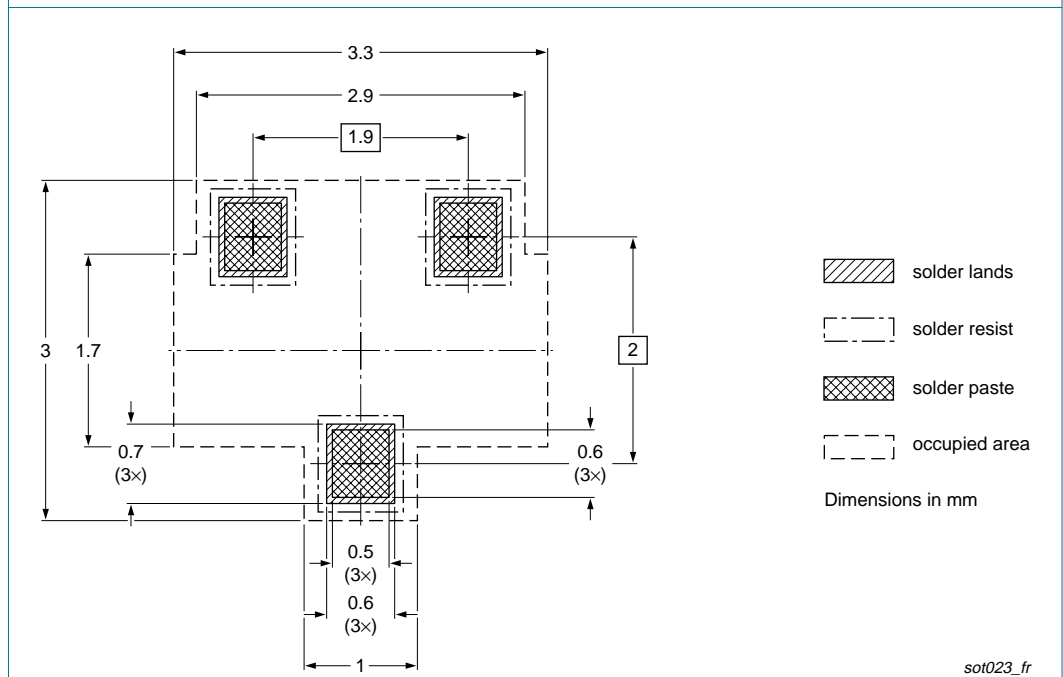

**Fig 11. Reflow soldering footprint PESD5V0X1BT (SOT23/TO-236AB)**

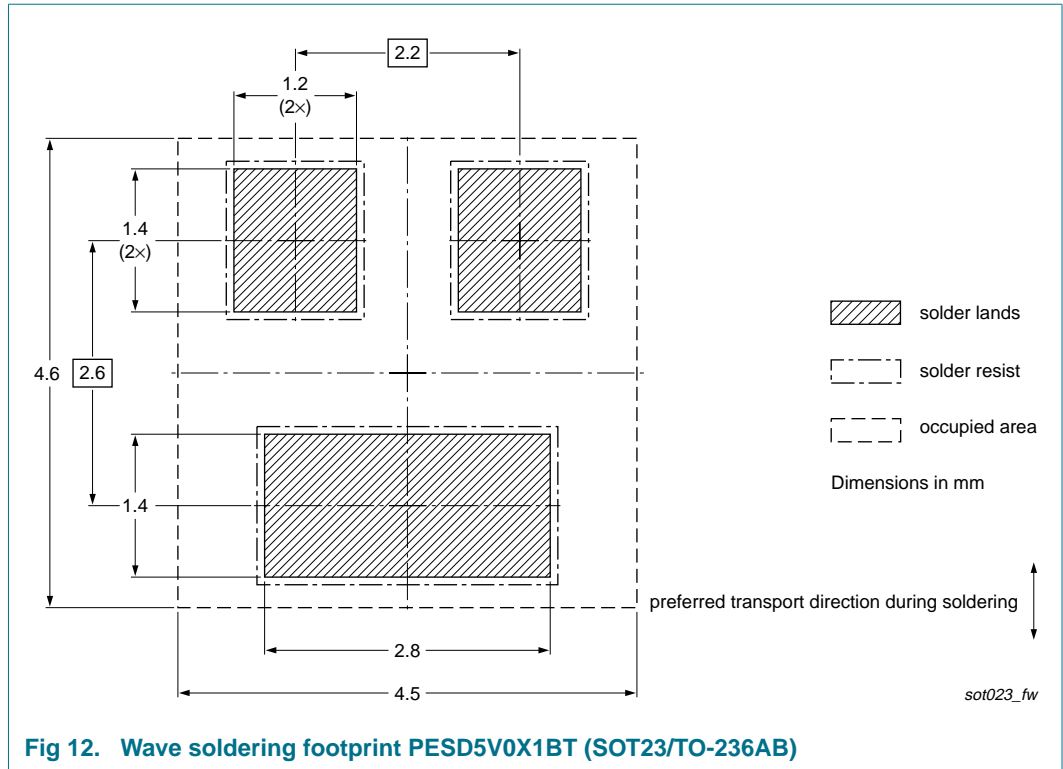

## 12. Revision history

**Table 11. Revision history**

Document ID	Release date	Data sheet status	Change notice	Supersedes
PESD5V0X1BQ_PESD5V0X1BT_1	20081030	Product data sheet	-	-

## 13. Legal information

### 13.1 Data sheet status

Document status <sup>[1][2]</sup>	Product status <sup>[3]</sup>	Definition
Objective [short] data sheet	Development	This document contains data from the objective specification for product development.
Preliminary [short] data sheet	Qualification	This document contains data from the preliminary specification.
Product [short] data sheet	Production	This document contains the product specification.

[1] Please consult the most recently issued document before initiating or completing a design.

[2] The term 'short data sheet' is explained in section "Definitions".

[3] The product status of device(s) described in this document may have changed since this document was published and may differ in case of multiple devices. The latest product status information is available on the Internet at URL <http://www.nxp.com>.

### 13.2 Definitions

**Draft** — The document is a draft version only. The content is still under internal review and subject to formal approval, which may result in modifications or additions. NXP Semiconductors does not give any representations or warranties as to the accuracy or completeness of information included herein and shall have no liability for the consequences of use of such information.

**Short data sheet** — A short data sheet is an extract from a full data sheet with the same product type number(s) and title. A short data sheet is intended for quick reference only and should not be relied upon to contain detailed and full information. For detailed and full information see the relevant full data sheet, which is available on request via the local NXP Semiconductors sales office. In case of any inconsistency or conflict with the short data sheet, the full data sheet shall prevail.

### 13.3 Disclaimers

**General** — Information in this document is believed to be accurate and reliable. However, NXP Semiconductors does not give any representations or warranties, expressed or implied, as to the accuracy or completeness of such information and shall have no liability for the consequences of use of such information.

**Right to make changes** — NXP Semiconductors reserves the right to make changes to information published in this document, including without limitation specifications and product descriptions, at any time and without notice. This document supersedes and replaces all information supplied prior to the publication hereof.

**Suitability for use** — NXP Semiconductors products are not designed, authorized or warranted to be suitable for use in medical, military, aircraft, space or life support equipment, nor in applications where failure or malfunction of an NXP Semiconductors product can reasonably be expected to result in personal injury, death or severe property or environmental damage. NXP Semiconductors accepts no liability for inclusion and/or use of NXP Semiconductors products in such equipment or applications and therefore such inclusion and/or use is at the customer's own risk.

**Applications** — Applications that are described herein for any of these products are for illustrative purposes only. NXP Semiconductors makes no representation or warranty that such applications will be suitable for the specified use without further testing or modification.

**Limiting values** — Stress above one or more limiting values (as defined in the Absolute Maximum Ratings System of IEC 60134) may cause permanent damage to the device. Limiting values are stress ratings only and operation of the device at these or any other conditions above those given in the Characteristics sections of this document is not implied. Exposure to limiting values for extended periods may affect device reliability.

**Terms and conditions of sale** — NXP Semiconductors products are sold subject to the general terms and conditions of commercial sale, as published at <http://www.nxp.com/profile/terms>, including those pertaining to warranty, intellectual property rights infringement and limitation of liability, unless explicitly otherwise agreed to in writing by NXP Semiconductors. In case of any inconsistency or conflict between information in this document and such terms and conditions, the latter will prevail.

**No offer to sell or license** — Nothing in this document may be interpreted or construed as an offer to sell products that is open for acceptance or the grant, conveyance or implication of any license under any copyrights, patents or other industrial or intellectual property rights.

**Quick reference data** — The Quick reference data is an extract of the product data given in the Limiting values and Characteristics sections of this document, and as such is not complete, exhaustive or legally binding.

**ESD protection devices** — These products are only intended for protection against ElectroStatic Discharge (ESD) pulses and are not intended for any other usage including, without limitation, voltage regulation applications. NXP Semiconductors accepts no liability for use in such applications and therefore such use is at the customer's own risk.

### 13.4 Trademarks

Notice: All referenced brands, product names, service names and trademarks are the property of their respective owners.

## 14. Contact information

For more information, please visit: <http://www.nxp.com>

For sales office addresses, please send an email to: [salesaddresses@nxp.com](mailto:salesaddresses@nxp.com)

## 15. Contents

<b>1</b>	<b>Product profile</b> . . . . .	<b>1</b>
1.1	General description . . . . .	1
1.2	Features . . . . .	1
1.3	Applications . . . . .	1
1.4	Quick reference data . . . . .	2
<b>2</b>	<b>Pinning information</b> . . . . .	<b>2</b>
<b>3</b>	<b>Ordering information</b> . . . . .	<b>2</b>
<b>4</b>	<b>Marking</b> . . . . .	<b>3</b>
<b>5</b>	<b>Limiting values</b> . . . . .	<b>3</b>
<b>6</b>	<b>Characteristics</b> . . . . .	<b>4</b>
<b>7</b>	<b>Application information</b> . . . . .	<b>7</b>
<b>8</b>	<b>Test information</b> . . . . .	<b>7</b>
8.1	Quality information . . . . .	7
<b>9</b>	<b>Package outline</b> . . . . .	<b>8</b>
<b>10</b>	<b>Packing information</b> . . . . .	<b>8</b>
<b>11</b>	<b>Soldering</b> . . . . .	<b>9</b>
<b>12</b>	<b>Revision history</b> . . . . .	<b>11</b>
<b>13</b>	<b>Legal information</b> . . . . .	<b>12</b>
13.1	Data sheet status . . . . .	12
13.2	Definitions . . . . .	12
13.3	Disclaimers . . . . .	12
13.4	Trademarks . . . . .	12
<b>14</b>	<b>Contact information</b> . . . . .	<b>12</b>
<b>15</b>	<b>Contents</b> . . . . .	<b>13</b>

Please be aware that important notices concerning this document and the product(s) described herein, have been included in section 'Legal information'.



© NXP B.V. 2008.

All rights reserved.

For more information, please visit: <http://www.nxp.com>

For sales office addresses, please send an email to: [salesaddresses@nxp.com](mailto:salesaddresses@nxp.com)

Date of release: 30 October 2008

Document identifier: PESD5V0X1BQ\_PESD5V0X1BT\_1