

Schottky Rectifier, 2 x 15 A

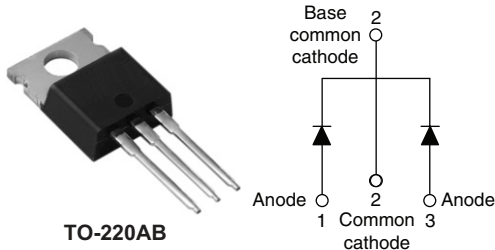

FEATURES

- 150 °C T_J operation
- Center tap TO-220 package
- Low forward voltage drop
- High frequency operation
- High purity, high temperature epoxy encapsulation for enhanced mechanical strength and moisture resistance
- Guard ring for enhanced ruggedness and long term reliability
- Lead (Pb)-free ("PbF" suffix)
- Designed and qualified for industrial level



RoHS*
COMPLIANT

PRODUCT SUMMARY

$I_{F(AV)}$	2 x 15 A
V_R	35/45 V
I_{RM}	40 mA at 125 °C

DESCRIPTION

This center tap Schottky rectifier has been optimized for low reverse leakage at high temperature. The proprietary barrier technology allows for reliable operation up to 150 °C junction temperature. Typical applications are in switching power supplies, converters, freewheeling diodes, and reverse battery protection.

MAJOR RATINGS AND CHARACTERISTICS

SYMBOL	CHARACTERISTICS	VALUES	UNITS
$I_{F(AV)}$	Rectangular waveform (per device)	30	A
V_{RRM}		35/45	V
I_{FRM}	$T_C = 130$ °C (per leg)	30	A
I_{FSM}	$t_p = 5$ μ s sine	1060	
V_F	30 Apk, $T_J = 125$ °C	0.73	V
T_J	Range	- 65 to 150	°C

VOLTAGE RATINGS

PARAMETER	SYMBOL	MBR2535CTPbF	MBR2545CTPbF	UNITS
Maximum DC reverse voltage	V_R	35	45	V
Maximum working peak reverse voltage	V_{RWM}			

ABSOLUTE MAXIMUM RATINGS

PARAMETER	SYMBOL	TEST CONDITIONS	VALUES	UNITS
Maximum average forward current per leg per device	$I_{F(AV)}$	$T_C = 130$ °C, rated V_R	15	A
			30	
Peak repetitive forward current per leg	I_{FRM}	Rated V_R , square wave, 20 kHz, $T_C = 130$ °C	30	
Non-repetitive peak surge current	I_{FSM}	5 μ s sine or 3 μ s rect. pulse	1060	
		Surge applied at rated load conditions halfwave, single phase, 60 Hz	150	
Non-repetitive avalanche energy per leg	E_{AS}	$T_J = 25$ °C, $I_{AS} = 2$ A, $L = 8$ mH	16	mJ
Repetitive avalanche current per leg	I_{AR}	Current decaying linearly to zero in 1 μ s Frequency limited by T_J maximum $V_A = 1.5 \times V_R$ typical	2	A

* Pb containing terminations are not RoHS compliant, exemptions may apply

ELECTRICAL SPECIFICATIONS					
PARAMETER	SYMBOL	TEST CONDITIONS		VALUES	UNITS
Maximum forward voltage drop	$V_{FM}^{(1)}$	30 A	$T_J = 25\text{ }^\circ\text{C}$	0.82	V
			$T_J = 125\text{ }^\circ\text{C}$	0.73	
Maximum instantaneous reverse current	$I_{RM}^{(1)}$	$T_J = 25\text{ }^\circ\text{C}$	Rated DC voltage	0.2	mA
		$T_J = 125\text{ }^\circ\text{C}$		40	
Threshold voltage	$V_{F(TO)}$	$T_J = T_J$ maximum		0.355	V
Forward slope resistance	r_t			12.3	$m\Omega$
Maximum junction capacitance	C_T	$V_R = 5\text{ }V_{DC}$ (test signal range 100 kHz to 1 MHz) 25 °C		700	pF
Typical series inductance	L_S	Measured from top of terminal to mounting plane		8.0	nH
Maximum voltage rate of change	dV/dt	Rated V_R		10 000	V/ μ s

Note

(1) Pulse width < 300 μ s, duty cycle < 2 %

THERMAL - MECHANICAL SPECIFICATIONS					
PARAMETER	SYMBOL	TEST CONDITIONS		VALUES	UNITS
Maximum junction temperature range	T_J			- 65 to 150	$^\circ\text{C}$
Maximum storage temperature range	T_{Stg}			- 65 to 175	
Maximum thermal resistance, junction to case per leg	R_{thJC}	DC operation		1.5	$^\circ\text{C/W}$
Typical thermal resistance, case to heatsink	R_{thCS}	Mounting surface, smooth and greased		0.50	
Approximate weight				2	g
				0.07	oz.
Mounting torque	minimum		Non-lubricated threads	6 (5)	kgf · cm (lbf · in)
	maximum			12 (10)	
Marking device		Case style TO-220AB		MBR2535CT	
				MBR2545CT	



MBR25..CTPbF Series

Schottky Rectifier, 2 x 15 A Vishay High Power Products

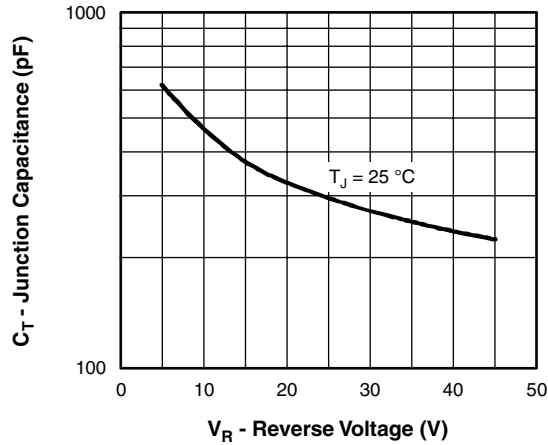
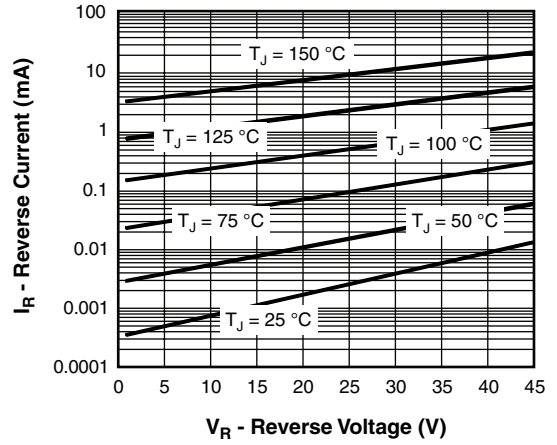
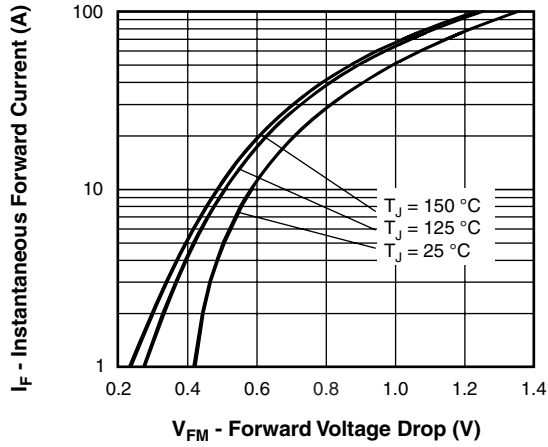

Fig. 3 - Typical Junction Capacitance vs. Reverse Voltage (Per Leg)

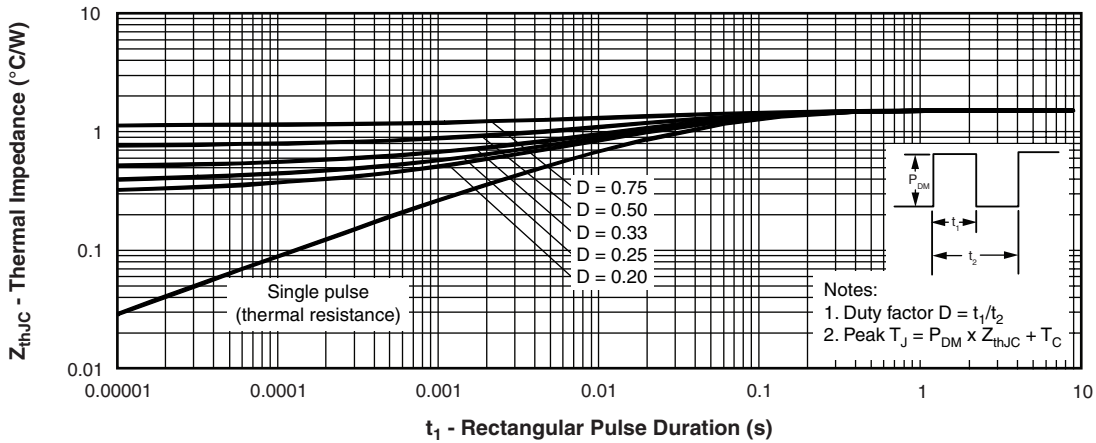

Fig. 4 - Maximum Thermal Impedance Z_{thJC} Characteristics (Per Leg)

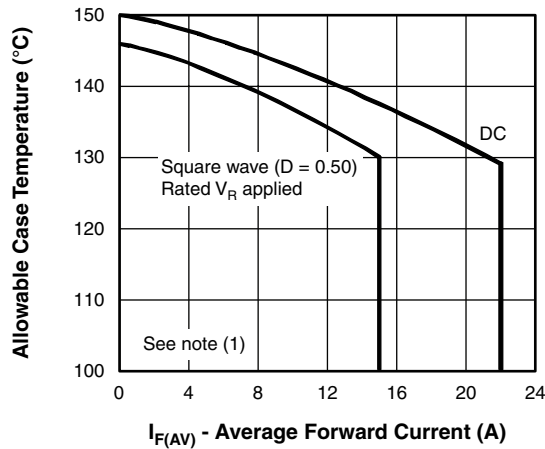

Fig. 5 - Maximum Allowable Case Temperature vs. Average Forward Current (Per Leg)

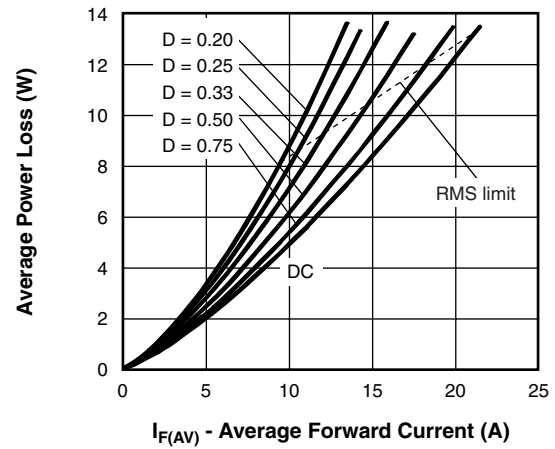

Fig. 6 - Forward Power Loss Characteristics (Per Leg)

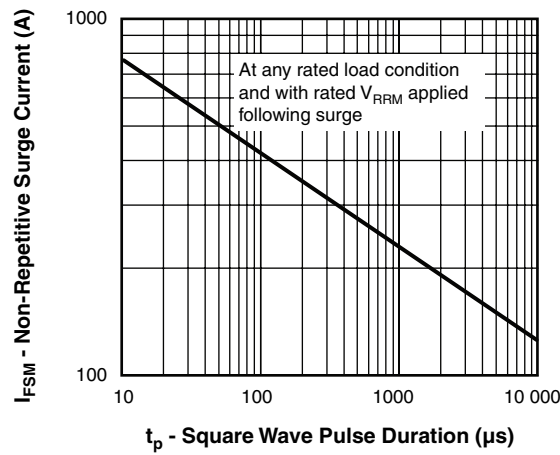

Fig. 7 - Maximum Non-Repetitive Surge Current (Per Leg)

Note

- (1) Formula used: $T_C = T_J - (P_d + P_{d_{REV}}) \times R_{thJC}$
 P_d = Forward power loss = $I_{F(AV)} \times V_{FM}$ at $(I_{F(AV)}/D)$ (see fig. 6);
 $P_{d_{REV}}$ = Inverse power loss = $V_{R1} \times I_R (1 - D)$; I_R at V_{R1} = Rated V_R



MBR25..CTPbF Series

Schottky Rectifier, 2 x 15 A Vishay High Power Products

ORDERING INFORMATION TABLE

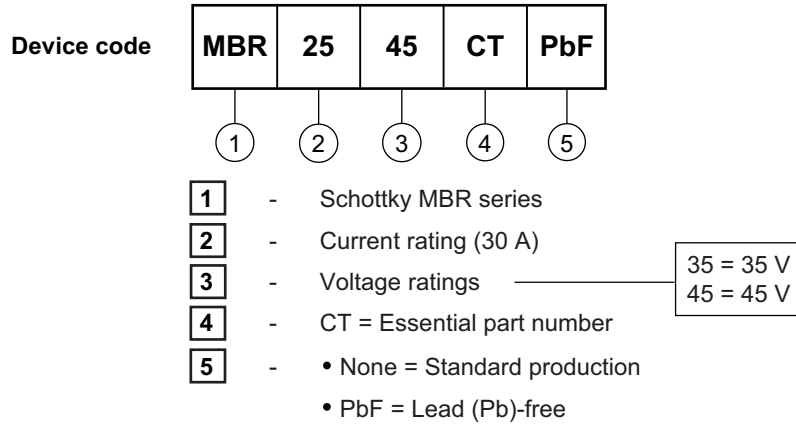

LINKS TO RELATED DOCUMENTS	
Dimensions	http://www.vishay.com/doc?95222
Part marking information	http://www.vishay.com/doc?95225



Disclaimer

All product specifications and data are subject to change without notice.

Vishay Intertechnology, Inc., its affiliates, agents, and employees, and all persons acting on its or their behalf (collectively, "Vishay"), disclaim any and all liability for any errors, inaccuracies or incompleteness contained herein or in any other disclosure relating to any product.

Vishay disclaims any and all liability arising out of the use or application of any product described herein or of any information provided herein to the maximum extent permitted by law. The product specifications do not expand or otherwise modify Vishay's terms and conditions of purchase, including but not limited to the warranty expressed therein, which apply to these products.

No license, express or implied, by estoppel or otherwise, to any intellectual property rights is granted by this document or by any conduct of Vishay.

The products shown herein are not designed for use in medical, life-saving, or life-sustaining applications unless otherwise expressly indicated. Customers using or selling Vishay products not expressly indicated for use in such applications do so entirely at their own risk and agree to fully indemnify Vishay for any damages arising or resulting from such use or sale. Please contact authorized Vishay personnel to obtain written terms and conditions regarding products designed for such applications.

Product names and markings noted herein may be trademarks of their respective owners.