

Emergency Stop Devices

Cable (Rope) Pull Switches

Lifeline 3



Description

The Lifeline 3 is a cable (rope) operated emergency stop device designed to meet the stringent requirements of EN 418 (Safety of Machinery—Emergency Stop Equipment). The Lifeline 3 system can be installed along or around awkward machinery such as conveyors and provides a constant-access emergency-stop facility.

The Lifeline 3 is the only device of its kind to incorporate the following features in one unit making it the most versatile cable switch on the market.

1. The positive-mode mechanism ensures that the contacts are immediately latched open on actuation and can only be reset by the intentional action of turning the blue reset knob. The design also protects against nuisance tripping and the effects of thermal expansion.
2. The cable-status indicator makes the system easy to set up and maintain for spans up to 30m (98ft).
3. Four sets of contacts are provided: 2 N.C. + 2 N.O., 3 N.C. + 1 N.O., or 4 N.C. contacts.
4. Sealed to IP67 with rugged construction using die-cast alloy and stainless steel to withstand harsh conditions.

Features

- Switches up to 30m (98ft) span
- Universal mounting and operation
- Switch lockout on cable pulled and cable slack
- Cable-status indicator on switch lid
- Industry standard fixing centres to DIN/EN 50041
- Quick disconnect styles available.

Specifications

Standards	EN 418, ISO 13850, ISOTR 12100, IEC 60947-5-1, IEC 60947-5-5
Approvals	CE marked for all applicable directives, cULus and TUV
Safety Contact	2 N.C. or 3 N.C. or 4 N.C. direct opening action
Designation/Utilization Cat.	
A600/AC-15 (Ue)	600V 500V 240V 120V
(Ie)	1.2A 1.4A 3A 6A
N600/DC-13 (Ue)	600V 500V 250V 125V
(Ie)	0.4A 0.55A 1.1A 2.2A
Thermal Current (Ith)	10 A
Minimum Current	5 V 5 mA
Safety Contact Gap	>2 x 2mm (0.078in)
Rtd. Impulse Withstand Voltage	(Uimp) 2500 V
Pollution Degree	3
Max. Actuation Frequency	1 cycle/s
Case Material	Heavy-duty die-cast aluminium alloy (LM24)
Eye Nut Material	Stainless steel
Indicator Material	Glass filled nylon
Protection	IP67
Conduit Entry	1 x 1/2in NPT, 1 x M20, quick-disconnect style
Operating Temperature	-25°C to +80°C (-13°F to +176°F)
Operation Force	<125N (28.1lb) (300mm deflection)
Tensioning Force to Run Position	103N (23.17lb) typical
Tensioning Force to Lockout	188N (42.3lb) typical
Max. Cable Span Between Switches	30m (98.42ft)
Fixing (mounting holes)	4 x M5
Mounting	Any position
Mechanical Life	1,000,000
Weight	610g (1.34lb)
Colour	Yellow body, blue reset button

Important: It is recommended that the LRTS (Lifeline Rope Tensioning System) should be used with the Lifeline 3 cable rope switch.



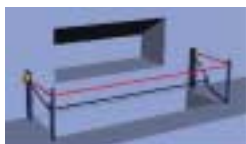

Typical Applications



Product Selection

Safety Contacts	Auxiliary Contacts	Catalogue Number		
		1/2in NPT Conduit	M20 Conduit	Quick Disconnect
2 N.C.	2 N.O.	440E-D13120	440E-D13118	440E-D13132
3 N.C.	1 N.O.	440E-D13114	440E-D13112	440E-D13124
4 N.C.	—	440E-D13108	440E-D13106	440E-D13136
	Recommended Standard Cable Connector/Cordset (2m (6.5ft) (see page 15-13).			889M-F12X9AE-2

Accessories

Description	Catalogue Number
 P. Bolt Complete M8 x 1.25 Thread Size 58mm (2.28in) Threaded Length 12mm (0.47in) Dia. Eye 95mm (3.74in) Overall Length	440E-A17003
 Lifeline Tensioner Spring 19mm (0.75in) Diameter 210mm (8.27in) Overall Length 50N Force	440E-A13078
 Inside Corner Pulley	440A-A17101
 Outside Corner Pulley	440A-A17102

Emergency Stop Devices

Cable (Rope) Pull Switches

Lifeline 3

Application Details—mm (inches)

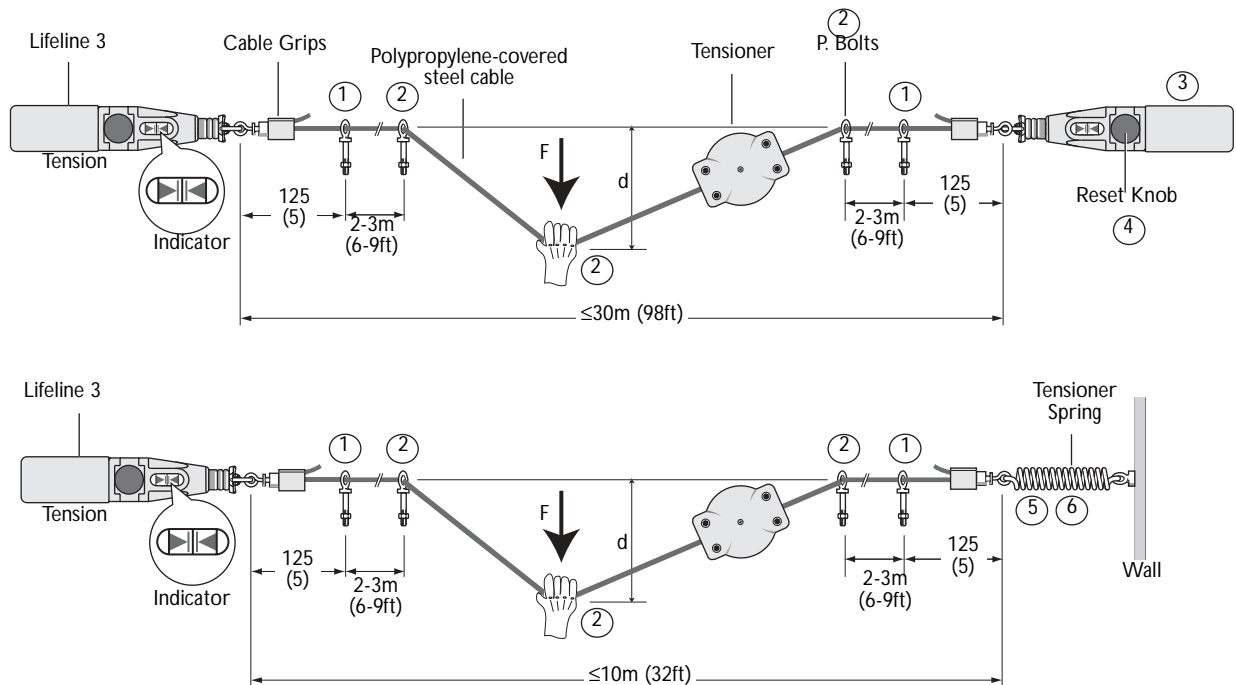

Notes:

1. The first and last P. Bolt must be located as close as possible to the switch eyelet while maintaining adequate clearance (125mm/5in) from the cable grips to allow free movement. This ensures a straight and efficient pulling action on the switches.
2. Additional P. Bolts, spaced 2-3m (6-9ft) apart, help keep the perpendicular pull force, F , and distance, d , within IEC60947-5-5 specifications of 200N (45lbs) and 400mm (15.75in).
3. We recommend using a switch at both cable ends, especially in applications with long cable runs or cable runs going around bends. This helps ensure that the safety function is fulfilled upon actuation of the cable in any direction.
4. ISO13850 (EN418) requires that the full length of cable to be within view when the reset is turned to the run position or the machine must be inspected over the whole length of the cable, both before and after resetting.
5. On shorter cable runs (max 10m), a Lifeline tensioner spring may be used at one end of the span. The installation must be such that the above requirements can be met. When a spring is used, the last P. Bolt must be located as close as possible to the spring while maintaining adequate clearance (125mm/5in) from the cable grips to allow free movement. This is intended to help to ensure that a pull near the end of the cable will be between P. Bolts. This should result in operation of the switch contacts instead of only the spring moving.
6. Careful attention is required for the design of the installation to ensure that the cable is not likely to become trapped or snagged. This is especially important when using a tensioner spring because a cable snag between the location of the pull and the switch could prevent the actuation of the safety function.
7. It is essential that when the installation is complete, a thorough functional test is made. This should include checking all types and directions of pull over the length of the cable as well as checking for slack-cable tripping.

Approximate Dimensions—mm (inches)

Dimensions are not intended to be used for installation purposes.

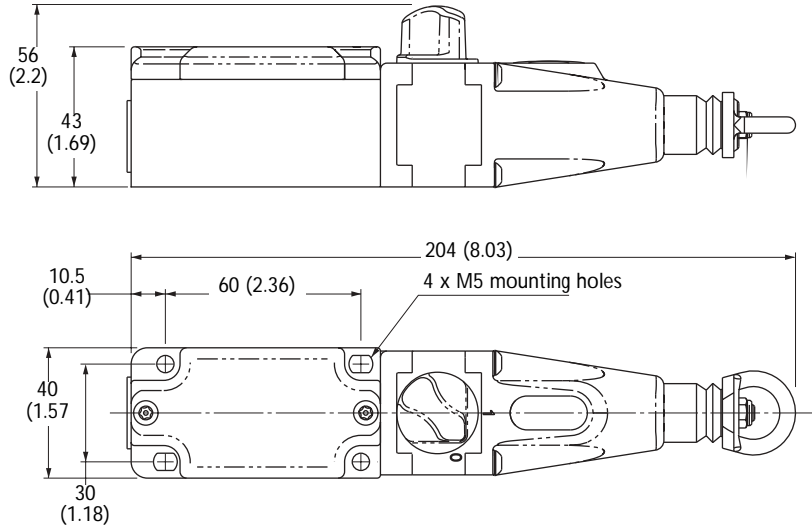

Typical Wiring Diagrams

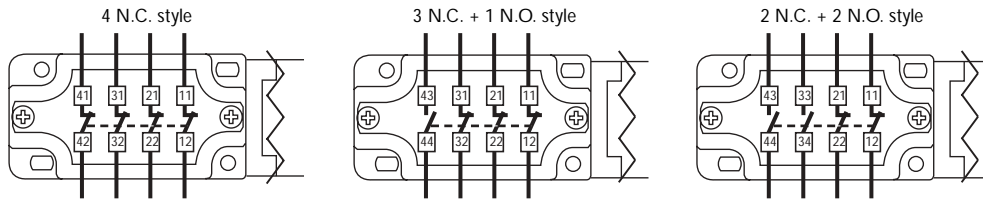

Connector Pinout	4 N.C.		3 N.C. + 1 N.O.		2 N.C. + 2 N.O.		
	Terminal	Contact	Terminal	Contact	Terminal	Contact	
	1	11	11	N.C.	11	N.C.	
	3	12	12	N.C.	12	N.C.	
	4	21	21	N.C.	21	N.C.	
	6	22	22	N.C.	22	N.C.	
	7	31	31	N.C.	33	N.O.	
	8	32	32	N.C.	34	N.O.	
	9	41	43	43	N.O.	43	N.O.
	10	42	44	44	N.O.	44	N.O.
	12	Ground					

Contact Action

□ Contact Open ■ Contact Closed

