

Silicon PNP Power Transistors

2SB829

DESCRIPTION

- With TO-3PN package
- Complement to type 2SD1065
- Wide area of safe operation
- Low collector saturation voltage :
 $V_{CE(sat)} = -0.5V$ max.

APPLICATIONS

- Relay drivers,
- High-speed inverters,converters
- General high-current switching applications

PINNING

PIN	DESCRIPTION
1	Base
2	Collector;connected to mounting base
3	Emitter

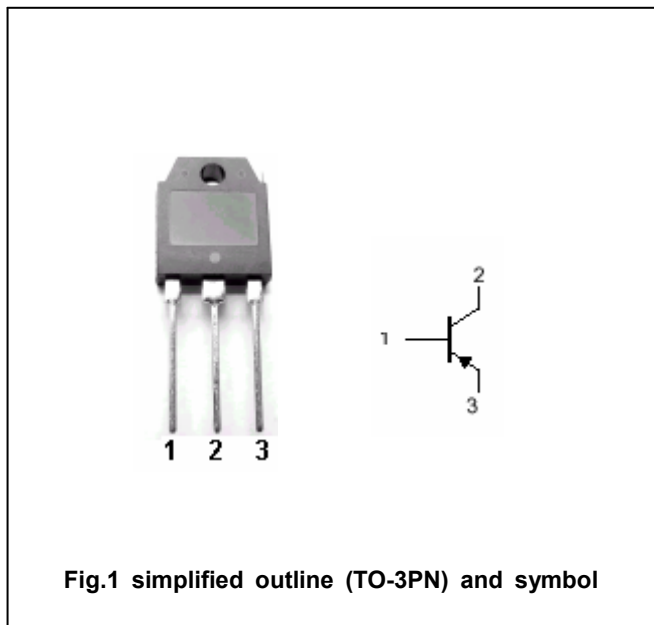

Fig.1 simplified outline (TO-3PN) and symbol

Absolute maximum ratings(Tc=25°C)

SYMBOL	PARAMETER	CONDITIONS	VALUE	UNIT
V_{CBO}	Collector-base voltage	Open emitter	-60	V
V_{CEO}	Collector-emitter voltage	Open base	-50	V
V_{EBO}	Emitter-base voltage	Open collector	-6	V
I_C	Collector current (DC)		-15	A
I_{CP}	Collector current (Pulse)		-20	A
P_C	Collector power dissipation	$T_c=25^\circ C$	90	W
T_j	Junction temperature		150	°C
T_{stg}	Storage temperature		-55~150	°C

Silicon PNP Power Transistors

2SB829

CHARACTERISTICS

T_j=25°C unless otherwise specified

SYMBOL	PARAMETER	CONDITIONS	MIN	TYP.	MAX	UNIT
V _{(BR)CEO}	Collector-emitter breakdown voltage	I _C =-1mA ; R _{BE} =∞	-50			V
V _{(BR)CBO}	Collector-base breakdown voltage	I _C =-1mA ; I _E =0	-60			V
V _{(BR)EBO}	Emitter-base breakdown voltage	I _E =-1mA ; I _C =0	-6			V
V _{CEsat}	Collector-emitter saturation voltage	I _C =-8A , I _B =-0.4A		-0.26	-0.5	V
I _{CBO}	Collector cut-off current	V _{CB} =-40V, I _E =0			-0.1	mA
I _{EBO}	Emitter cut-off current	V _{EB} =-4V; I _C =0			-0.1	mA
h _{FE-1}	DC current gain	I _C =-1A ; V _{CE} =-2V	70		280	
h _{FE-2}	DC current gain	I _C =-8A ; V _{CE} =-2V	30			
f _T	Transition frequency	I _C =-1A ; V _{CE} =-5V		20		MHz

Switching times

t _{on}	Turn-on time	I _C =-2.0A; I _{B1} =-I _{B2} =-0.2A V _{CC} =20V; R _L =10Ω		0.20		μs
t _{stg}	Storage time			0.10		μs
t _f	Fall time			0.50		μs

◆ h_{FE-1} Classifications

Q	R	S
70-140	100-200	140-280

Silicon PNP Power Transistors

2SB829

PACKAGE OUTLINE

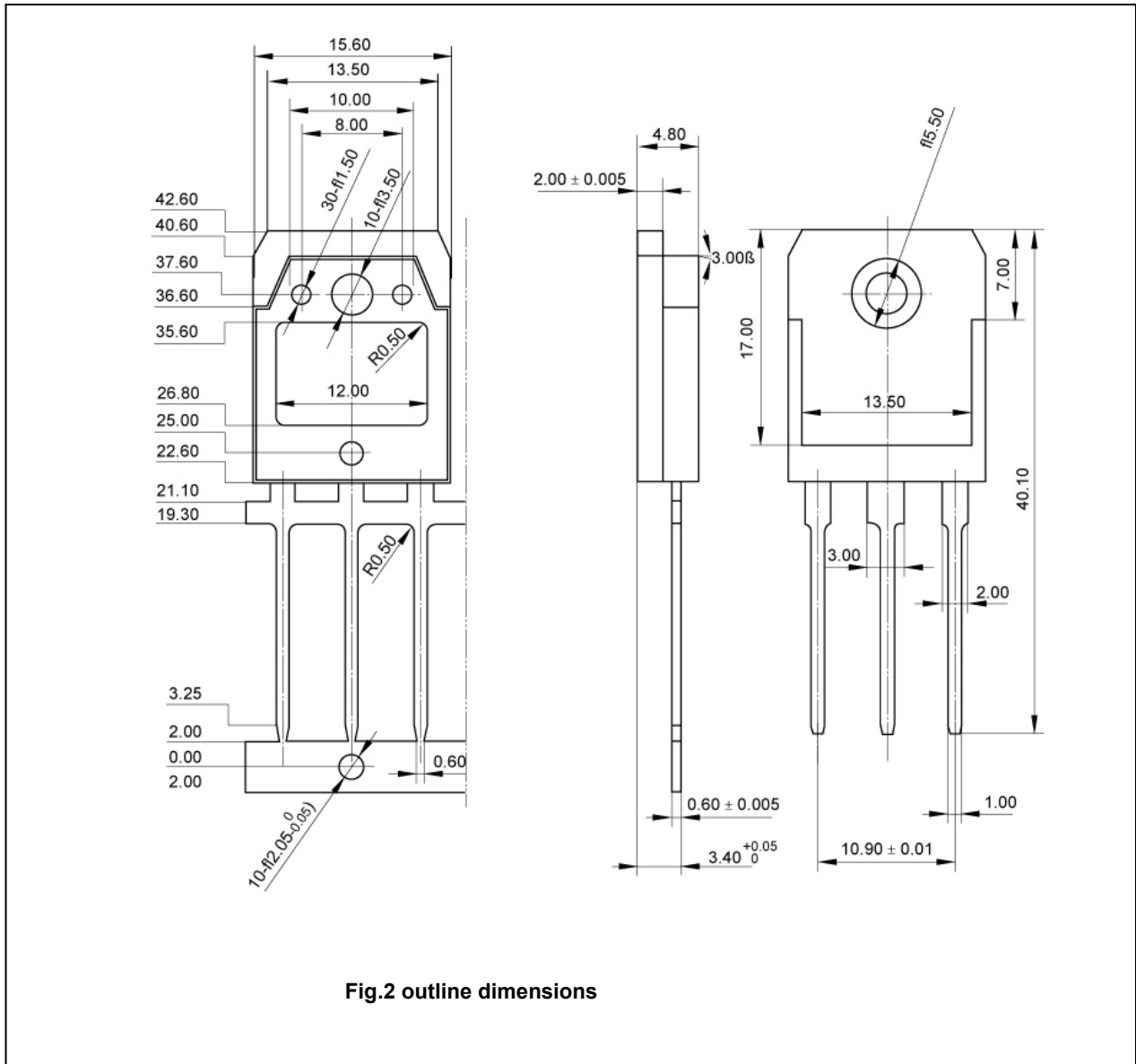

Fig.2 outline dimensions

Silicon PNP Power Transistors

2SB829

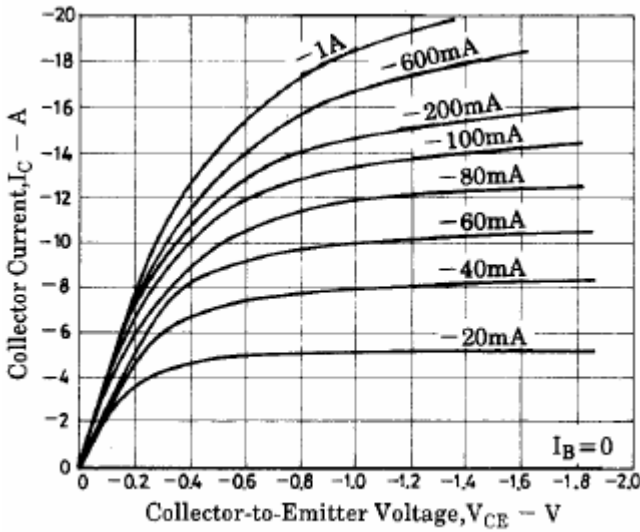

Fig.3 Static Characteristic

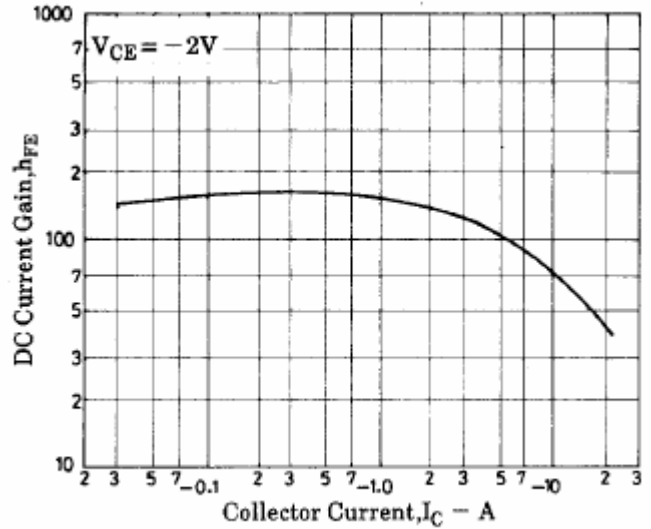

Fig.4 DC current Gain

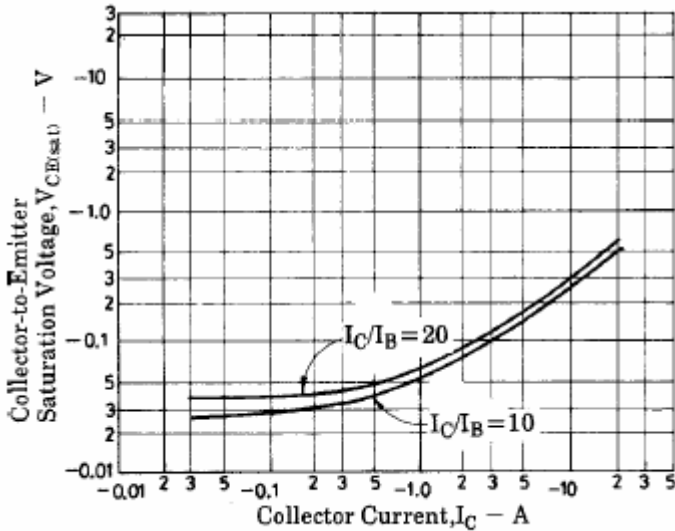

Fig.5 Collector-Emitter Saturation Voltage

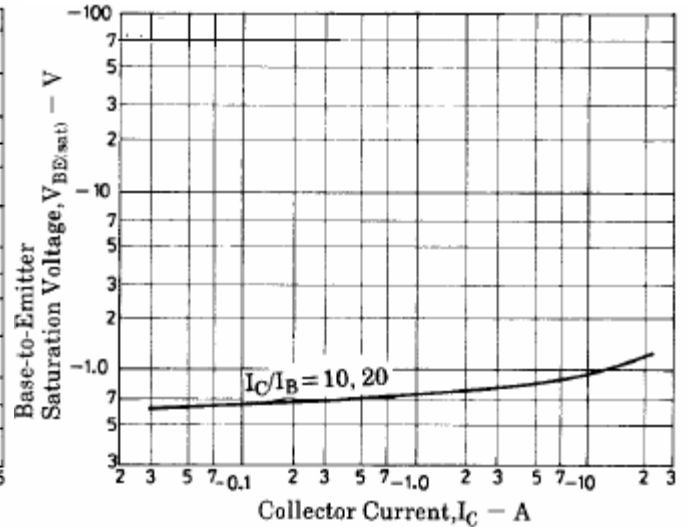

Fig.6 Base-Emitter Saturation Voltage

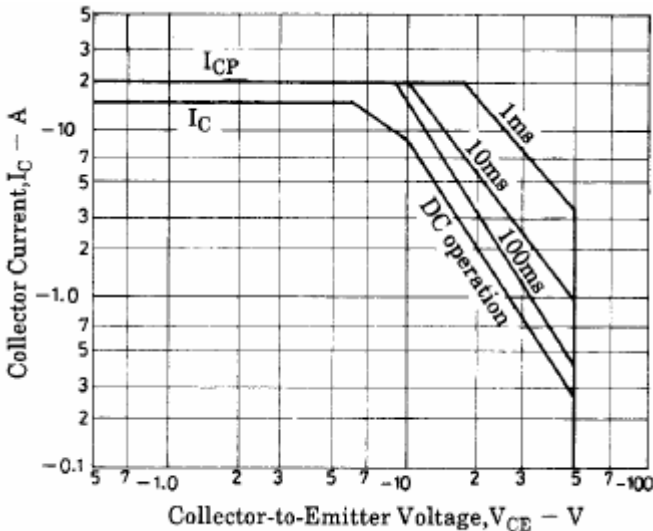

Fig.7 Safe Operating Area