

## HEXFRED® Ultrafast Soft Recovery Diode, 60 A

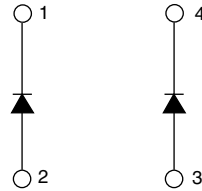

SOT-227

**FEATURES**

- Fast recovery time characteristic
- Electrically isolated base plate
- Large creepage distance between terminal
- Simplified mechanical designs, rapid assembly
- UL pending
- Totally lead (Pb)-free
- Designed and qualified for industrial level

**RoHS  
COMPLIANT**
**PRODUCT SUMMARY**

$V_R$	1200 V
$V_F$ (typical)	2.2 V
$t_{rr}$ (typical)	123 ns
$I_{F(DC)}$ at $T_C$	30 A at 110 °C

**DESCRIPTION/APPLICATIONS**

The dual diode series configuration (HFA60FA120P) is used for output rectification or freewheeling/clamping operation and high voltage application.

The semiconductor in the SOT-227 package is isolated from the copper base plate, allowing for common heatsinks and compact assemblies to be built.

These modules are intended for general applications such as HV power supplies, electronic welders, motor control and inverters.

**ABSOLUTE MAXIMUM RATINGS**

PARAMETER	SYMBOL	TEST CONDITIONS	MAX.	UNITS
Cathode to anode voltage	$V_R$		1200	V
Continuous forward current	$I_F$	$T_C = 110\text{ °C}$	30	A
Single pulse forward current	$I_{FSM}$	$T_J = 25\text{ °C}$	350	
Maximum repetitive forward current	$I_{FRM}$	Rated $V_R$ , square wave, 20 kHz, $T_C = 60\text{ °C}$	110	
Maximum power dissipation	$P_D$	$T_C = 25\text{ °C}$	216	W
		$T_C = 100\text{ °C}$	86	
RMS isolation voltage	$V_{ISOL}$	Any terminal to case, $t = 1$ minute	2500	V
Operating junction and storage temperature range	$T_J, T_{Stg}$		- 55 to + 150	°C

**ELECTRICAL SPECIFICATIONS** ( $T_J = 25\text{ °C}$  unless otherwise specified)

PARAMETER	SYMBOL	TEST CONDITIONS	MIN.	TYP.	MAX.	UNITS
Cathode to anode breakdown voltage	$V_{BR}$	$I_R = 100\ \mu\text{A}$	1200	-	-	V
Forward voltage	$V_{FM}$	$I_F = 30\text{ A}$	-	2.2	3.0	
		$I_F = 60\text{ A}$	-	2.7	3.8	
Reverse leakage current	$I_{RM}$	$V_R = V_R$ rated	-	1.0	75	$\mu\text{A}$
		$T_J = 150\text{ °C}$ , $V_R = V_R$ rated	-	2.7	10	mA

<b>DYNAMIC RECOVERY CHARACTERISTICS</b> ( $T_J = 25\text{ °C}$ unless otherwise specified)							
PARAMETER	SYMBOL	TEST CONDITIONS		MIN.	TYP.	MAX.	UNITS
Reverse recovery time	$t_{rr}$	$T_J = 25\text{ °C}$	$I_F = 50\text{ A}$ $di_F/dt = -200\text{ A}/\mu\text{s}$ $V_R = 200\text{ V}$	-	123	-	ns
		$T_J = 125\text{ °C}$		-	188	-	
Peak recovery current	$I_{RRM}$	$T_J = 25\text{ °C}$		-	12	-	A
		$T_J = 125\text{ °C}$		-	17	-	
Reverse recovery charge	$Q_{rr}$	$T_J = 25\text{ °C}$		-	675	-	nC
		$T_J = 125\text{ °C}$		-	1500	-	

<b>THERMAL - MECHANICAL SPECIFICATIONS</b>						
PARAMETER	SYMBOL	TEST CONDITIONS	MIN.	TYP.	MAX.	UNITS
Junction to case, single leg conducting	$R_{thJC}$		-	-	0.58	°C/W
Junction to case, both legs conducting			-	-	0.29	
Case to heatsink	$R_{thCS}$	Flat, greased and surface	-	0.05	-	
Weight			-	30	-	g
Mounting torque			-	1.3	-	Nm



HEXFRED®  
Ultrafast Soft Recovery  
Diode, 60 A

Vishay High Power Products

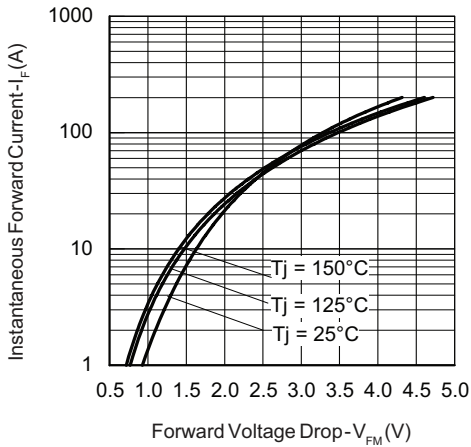

Fig. 1 - Typical Forward Voltage Drop Characteristics

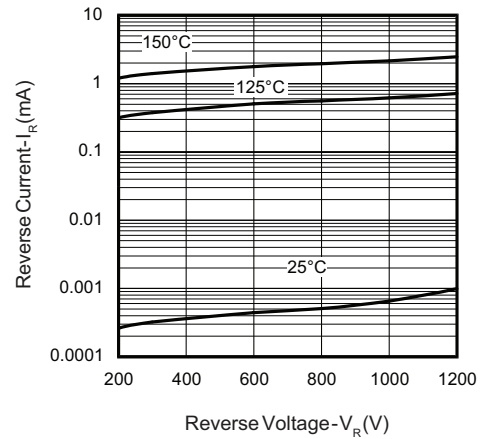

Fig. 2 - Typical Values of Reverse Current vs. Reverse Voltage

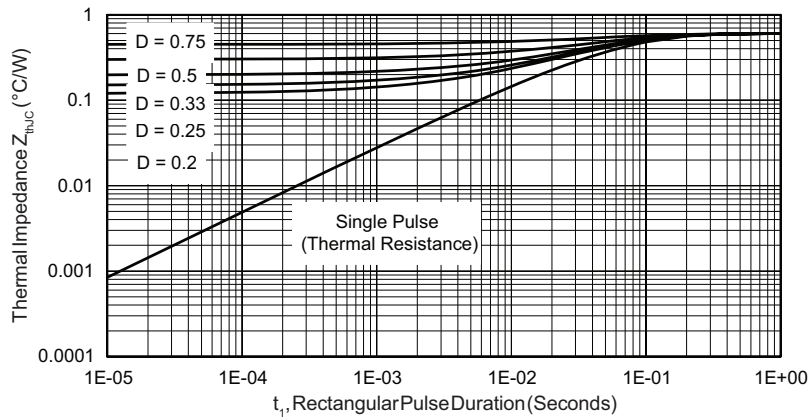

Fig. 3 - Maximum Thermal Impedance  $Z_{thJC}$  Characteristics

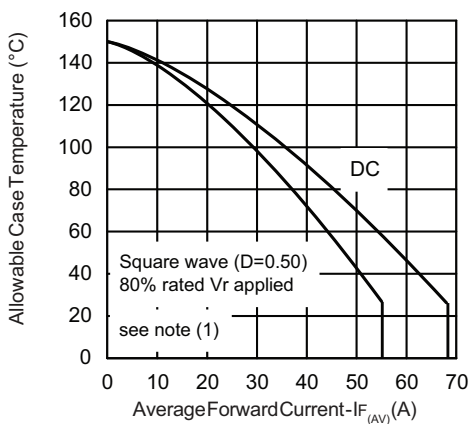

Fig. 4 - Maximum Allowable Case Temperature vs. Average Forward Current

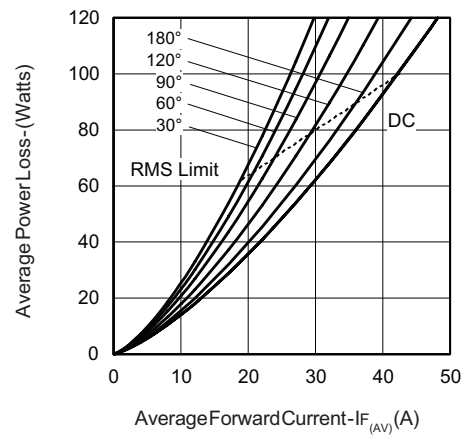

Fig. 5 - Forward Power Loss Characteristics

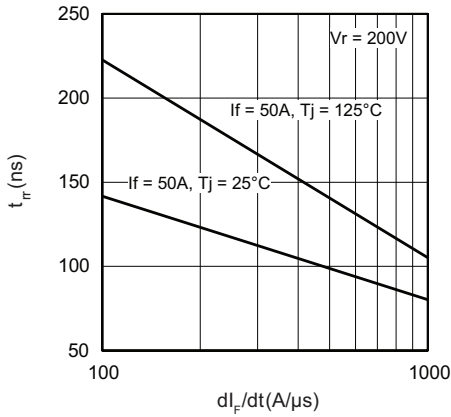

Fig. 6 - Typical Reverse Recovery Time vs.  $dI_F/dt$

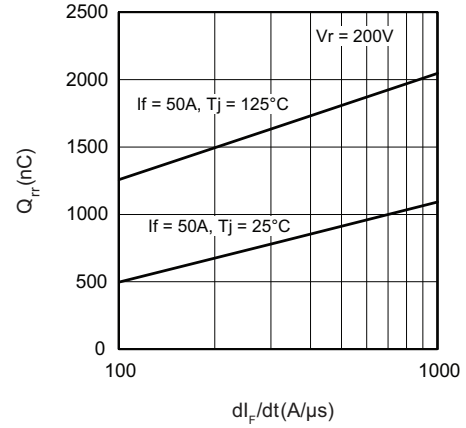

Fig. 7 - Typical Stored Charge vs.  $dI_F/dt$

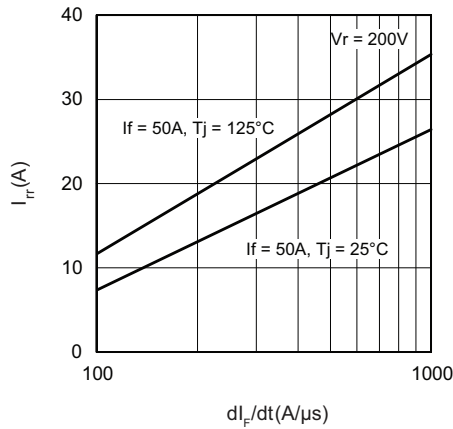

Fig. 8 - Typical Peak Recovery Current vs.  $dI_F/dt$

**Note**

- (1) Formula used:  $T_C = T_J - (P_d + P_{d_{REV}}) \times R_{thJC}$ ;  
 $P_d$  = Forward power loss =  $I_{F(AV)} \times V_{FM}$  at  $(I_{F(AV)}/D)$  (see fig. 5);  
 $P_{d_{REV}}$  = Inverse power loss =  $V_{R1} \times I_R (1 - D)$ ;  $I_R$  at  $V_{R1}$  = Rated  $V_R$

**HEXFRED®  
Ultrafast Soft Recovery  
Diode, 60 A**

Vishay High Power Products

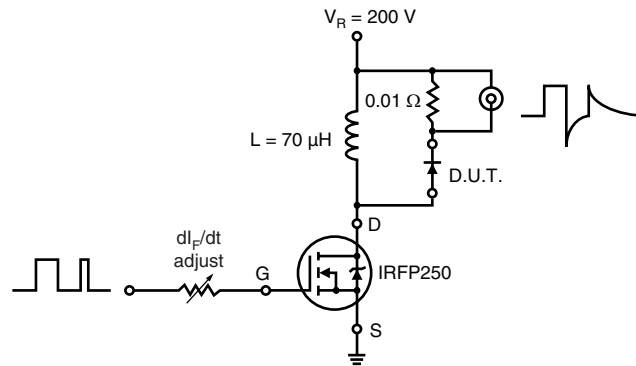
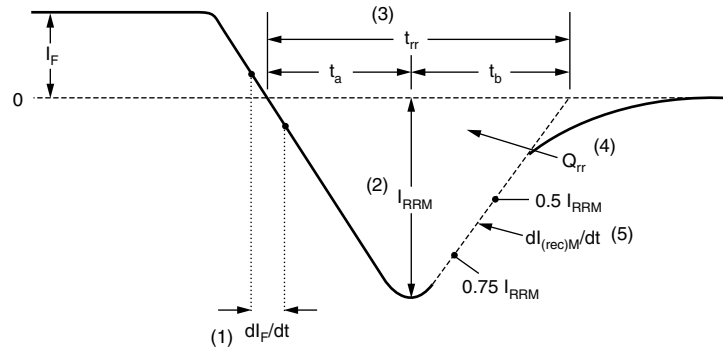

Fig. 9 - Reverse Recovery Parameter Test Circuit

 (1)  $dI_F/dt$  - rate of change of current through zero crossing

 (2)  $I_{RRM}$  - peak reverse recovery current

 (3)  $t_{rr}$  - reverse recovery time measured from zero crossing point of negative going  $I_F$  to point where a line passing through  $0.75 I_{RRM}$  and  $0.50 I_{RRM}$  extrapolated to zero current.

 (4)  $Q_{rr}$  - area under curve defined by  $t_{rr}$  and  $I_{RRM}$ 

$$Q_{rr} = \frac{t_{rr} \times I_{RRM}}{2}$$

 (5)  $dI_{(rec)M}/dt$  - peak rate of change of current during  $t_b$  portion of  $t_{rr}$ 

Fig. 10 - Reverse Recovery Waveform and Definitions

# HFA60FA120P

Vishay High Power Products

HEXFRED®  
Ultrafast Soft Recovery  
Diode, 60 A



## ORDERING INFORMATION TABLE

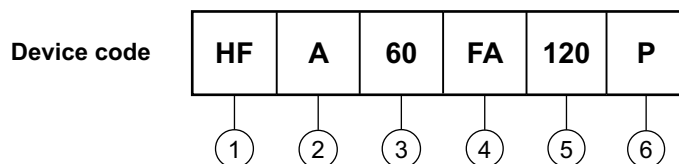

- 1** - HEXFRED® family
- 2** - Process designator (A = Electron irradiated)
- 3** - Average current (60 = 60 A)
- 4** - Package outline (FA = SOT-227)
- 5** - Voltage rating (120 = 1200 V)
- 6** - P = Lead (Pb)-free

LINKS TO RELATED DOCUMENTS	
Dimensions	<a href="http://www.vishay.com/doc?95036">http://www.vishay.com/doc?95036</a>
Packaging information	<a href="http://www.vishay.com/doc?95037">http://www.vishay.com/doc?95037</a>



## Disclaimer

All product specifications and data are subject to change without notice.

Vishay Intertechnology, Inc., its affiliates, agents, and employees, and all persons acting on its or their behalf (collectively, "Vishay"), disclaim any and all liability for any errors, inaccuracies or incompleteness contained herein or in any other disclosure relating to any product.

Vishay disclaims any and all liability arising out of the use or application of any product described herein or of any information provided herein to the maximum extent permitted by law. The product specifications do not expand or otherwise modify Vishay's terms and conditions of purchase, including but not limited to the warranty expressed therein, which apply to these products.

No license, express or implied, by estoppel or otherwise, to any intellectual property rights is granted by this document or by any conduct of Vishay.

The products shown herein are not designed for use in medical, life-saving, or life-sustaining applications unless otherwise expressly indicated. Customers using or selling Vishay products not expressly indicated for use in such applications do so entirely at their own risk and agree to fully indemnify Vishay for any damages arising or resulting from such use or sale. Please contact authorized Vishay personnel to obtain written terms and conditions regarding products designed for such applications.

Product names and markings noted herein may be trademarks of their respective owners.