ST-NXP Wireless

IMPORTANT NOTICE

Dear customer,

As from August 2nd 2008, the wireless operations of STMicroelectronics have moved to a new company, ST-NXP Wireless.

As a result, the following changes are applicable to the attached document.

- **Company name - STMicroelectronics NV** is replaced with **ST-NXP Wireless**.
- **Copyright** - the copyright notice at the bottom of the last page “© STMicroelectronics 200x - All rights reserved”, shall now read: “© ST-NXP Wireless 200x - All rights reserved”.
- **Web site** - <http://www.st.com> is replaced with <http://www.stnwireless.com>
- **Contact information** - the list of sales offices is found at <http://www.stnwireless.com> under Contacts.

If you have any questions related to the document, please contact our nearest sales office. Thank you for your cooperation and understanding.

ST-NXP Wireless

Dual low power asynchronous stereo audio Codec with integrated power amplifiers

Features

- Dual 20 bit audio resolution, 8kHz to 96kHz independent rate ADC and DAC
- Dual I²S or PCM digital interfaces for dual master
- Sustain complex voice and audio flow with or without mixing
- I²C/SPI compatible control I/F
- Asynchronous sampling ADC and DAC: they do not require oversampled clock and information on the audio data sampling frequency (fs). Jitter tolerant fs
- Wide master clock range: from 4MHz to 32MHz
- Stereo headphones drivers, handsfree loudspeaker driver, line out drivers
- Mixable analog line inputs
- Voice filters: 8/16kHz with voice channel filters
- Automatic gain control for microphone and line-in inputs
- Frequency programmable clock outputs
- Multibit $\Sigma\Delta$ modulators with data weighted averaging ADC and DAC
- DSP functions for bass-treble-volume control, mute, mono/stereo selection, voice channel filters, de-emphasis filter and dynamic compression
- 93 dB dynamic range ADC, 0.001% THD with full scale output @ 2.7V
- 95 dB dynamic range DAC, 0.02% THD performance @ 2.7V over 16 Ω load

Applications

- Digital cellular telephones with application processor such as mp3 or gaming and Bluetooth concurrent application

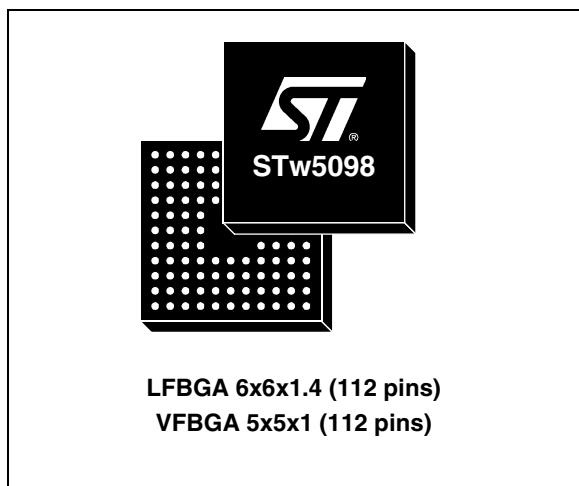

Description

STw5098 is a dual low power asynchronous stereo audio CODEC device with headphones amplifiers for high quality audio listening and recording.

Two I2S/PCM digital interfaces are available, one per master for example Bluetooth and Application Processor, enabling concurrent audio and voice flow between Network and user.

The STw5098 control registers are accessible through a selectable I²C-bus compatible or SPI compatible interface.

Contents

- 1 Overview 8**
- 2 Pinout 9**
- 3 Block diagram 16**
- 4 Functional description 17**
 - 4.1 Naming convention 17
 - 4.2 Power supply 17
 - 4.3 Device programming 18
 - 4.4 Power up 19
 - 4.5 Master clock 19
 - 4.6 Data rates 20
 - 4.7 Clock generators and master mode function 20
 - 4.8 Audio digital interfaces 21
 - 4.9 Analog inputs 22
 - 4.10 Analog output drivers 23
 - 4.11 Analog mixers 24
 - 4.12 AD paths 24
 - 4.13 DA paths 25
 - 4.14 Analog-only operations 25
 - 4.15 Automatic Gain Control (AGC) 25
 - 4.16 Interrupt request: IRQ pins 26
 - 4.17 Headset plug-in and push-button detection 26
 - 4.18 Microphone biasing circuits 27
- 5 Control registers 28**
 - 5.1 Summary 28
 - 5.2 Supply and power control 30
 - 5.3 Gains 32
 - 5.4 DSP control 36
 - 5.5 Analog functions 39

5.6	Digital audio interfaces master mode and clock generators	41
5.7	Digital audio interfaces	43
5.8	Digital filters, software reset and master clock control	45
5.9	Interrupt control and control interface SPI out mode	46
5.10	AGC	48
6	Control interface and master clock	50
6.1	Control interface I2C mode	50
6.2	Control interface SPI mode	51
6.3	Master clock timing	53
7	Audio interfaces	54
8	Timing specifications	58
9	Operative ranges	59
9.1	Absolute maximum ratings	59
9.2	Operative supply voltage	59
9.3	Power dissipation	60
9.4	Typical power dissipation by entity	60
10	Electrical characteristics	62
10.1	Digital interfaces	62
10.2	AMCK with sinusoid input	62
10.3	Analog interfaces	63
10.4	Headset plug-in and push-button detector	64
10.5	Microphone bias	64
10.6	Power supply rejection ratio	64
10.7	LS and EAR gain limiter	65
11	Analog input/output operative ranges	66
11.1	Analog levels	66
11.2	Microphone input levels	66
11.3	Line output levels	67
11.4	Power output levels HP	67

	11.5	Power output levels LS and EAR	67
12		Stereo audio ADC specifications	69
13		Stereo audio DAC specifications	70
14		AD to DA mixing (sidetone) specifications	71
15		Stereo analog-only path specifications	72
16		ADC (TX) & DAC (RX) specifications with voice filters selected	73
17		Typical performance plots	74
18		Package mechanical data	77
	18.1	LFBGA 6x6x1.4	78
	18.2	VFBGA 5x5x1.0	80
19		Application schematics	82
20		Ordering information	84
21		Revision history	84

List of tables

Table 1.	STw5098 pin description	10
Table 2.	Control register summary	28
Table 3.	CR0 description	30
Table 4.	CR1 description	31
Table 5.	CR2 description	31
Table 6.	CR3 and CR4 description	32
Table 7.	CR5 and CR6 description	33
Table 8.	CR7 description	33
Table 9.	CR8 and CR9 description	33
Table 10.	CR10 and CR11 description	34
Table 11.	CR12 and CR13 description	35
Table 12.	CR14 description	36
Table 13.	CR15 description	37
Table 14.	CR16 description	38
Table 15.	CR17 description	39
Table 16.	CR18 description	39
Table 17.	CR19 description	40
Table 18.	CR21-20 and CR24-23 description	41
Table 19.	CR22 and CR25 description	41
Table 20.	CR26 description	43
Table 21.	CR27 description	43
Table 22.	CR28 description	44
Table 23.	CR29 description	45
Table 24.	CR30 description	45
Table 25.	CR31 description	46
Table 26.	CR32 description	46
Table 27.	CR33 description	47
Table 28.	CR 34 description	48
Table 29.	CR 35 description	49
Table 30.	Control interface timing with I ² C format	51
Table 31.	Control interface signal timing with SPI format	52
Table 32.	AMCK timing	53
Table 33.	Audio interface signal timings	57
Table 34.	Absolute maximum ratings	59
Table 35.	Operative supply voltage	59
Table 36.	Power dissipation	60
Table 37.	Typical power dissipation, no master clock	60
Table 38.	Typical power dissipation with master clock AMCK = 13 MHz	61
Table 39.	Digital interfaces specifications	62
Table 40.	AMCK with sinusoid input specifications	62
Table 41.	Analog interface specifications	63
Table 42.	Headset plug-in and push-button detector specifications	64
Table 43.	Microphone bias specifications	64
Table 44.	Power supply rejection ratio specifications	64
Table 45.	LS and EAR gain limiter	65
Table 46.	Reference full scale analog levels	66
Table 47.	Microphone input levels, absolute levels at pins connected to preamplifiers	66
Table 48.	Microphone input levels, absolute levels at pins connected to the line-in amplifiers	66

Table 49.	Absolute levels at OLP/OLN, ORP/ORN	67
Table 50.	Absolute levels at HPL - HPR	67
Table 51.	Absolute levels at 1EARP-1EARN and 2LSP - 2LSN	68
Table 52.	Stereo audio ADC specifications	69
Table 53.	Stereo audio DAC specifications	70
Table 54.	AD to DA mixing (sidetone) specifications	71
Table 55.	Stereo analog-only path specifications	72
Table 56.	ADC (TX) & DAC (RX) specifications with voice filters selected	73
Table 57.	Dimensions of LFBGA 6x6x1.4 112 4R11x11. 0.5	78
Table 58.	Dimensions of VFBGA 5x5x1.0 112 balls 0.4 mm pitch	80
Table 59.	Order codes	84
Table 60.	Document revision history	84

List of figures

Figure 1.	Pin assignment	9
Figure 2.	STw5098 block diagram	16
Figure 3.	Power up block diagram: example shown for one entity	19
Figure 4.	Plug-in and push-button detection application note	26
Figure 5.	Control interface I2C format	50
Figure 6.	Control interface: I2C format timing	50
Figure 7.	Control interface SPI format	51
Figure 8.	Control interface: SPI format timing	52
Figure 9.	Audio interfaces formats: delayed, left and right justified	54
Figure 10.	Audio interfaces formats: DSP, SPI and PCM	55
Figure 11.	Audio interface timings: master mode	56
Figure 12.	Audio interface timing: slave mode	56
Figure 13.	A.C. testing input-output waveform	58
Figure 14.	Bass treble control, de-emphasis filter	74
Figure 15.	Dynamic compressor transfer function	74
Figure 16.	ADC audio path measured filter response	74
Figure 17.	ADC in band audio path measured filter response	74
Figure 18.	DAC digital audio filter characteristics	74
Figure 19.	DAC in band digital audio filter characteristics	74
Figure 20.	ADC 96 kHz audio path measured filter response	75
Figure 21.	ADC 96 kHz audio in-band measured filter response	75
Figure 22.	ADC voice TX path measured filter response	75
Figure 23.	ADC voice TX path measured in-band filter response	75
Figure 24.	DAC voice (RX) digital filter characteristics	75
Figure 25.	DAC voice (RX) in-band digital filter characteristics	75
Figure 26.	ADC path FFT	76
Figure 27.	ADC S/N versus input-level	76
Figure 28.	DAC path FFT	76
Figure 29.	DAC S/N versus input-level	76
Figure 30.	Analog path FFT	76
Figure 31.	Analog path S/N versus input-level	76
Figure 32.	LFPGA 6x6x1.4 112 4R11x11 0.5 drawing	79
Figure 33.	VFBGA 5x5x1.0 112 0.4 drawing	81
Figure 34.	STw5098 application schematics	83

1 Overview

- Dual 20 bit audio resolution, 8kHz to 96kHz independent rate ADC and DAC
- Dual I²S/PCM digital interfaces for dual master
- Sustain complex voice and audio flow with or without mixing
- Two I²C/SPI compatible independent control interfaces
- Asynchronous sampling ADC and DAC that do not require oversampled clock and information on the audio data sampling frequency (fs). Jitter tolerant fs
- Wide master clock range from 4MHz to 32MHz
- Two stereo headphones drivers, hand free loudspeaker driver, line out drivers
- Mixable analog line inputs
- Voice filters: 8/16kHz with voice channel filters
- Automatic gain control for microphone and line-in inputs
- Four programmable master/slave serial audio data interfaces: I²S, SPI, PCM compatible and other formats
- Frequency programmable clock outputs
- Multibit $\Sigma\Delta$ modulators with data weighted averaging ADC and DAC
- Four DSP functions for bass-treble-volume control, mute, mono/stereo selection, voice channel filters, de-emphasis filter and dynamic compression
- 93 dB dynamic range ADC, 0.001% THD with full scale with full scale output @ 2.7V
- 95 dB dynamic range DAC, 0.02% THD performance @ 2.7V over 16 Ω load

Analog inputs

- Selectable stereo differential or single-ended microphone amplifier inputs with 51dB range programmable gain
- 2 microphone biasing output
- Microphone plug-in and push-button detection input
- Selectable stereo differential or single-ended line inputs with 38dB range programmable gain

Analog output drivers

- 2 Stereo headphones outputs. driving capability: 40mW (0.1% THD) over 16 Ω with 40dB range programmable gain
- Common mode voltage headphones driver (phantom ground)
- 1 Balanced loudspeaker output with driving capability up to 500mW ($V_{CCLS}>3.5V$; 1% THD) over 8 Ω with 30dB range programmable gain
- 1 Balanced earphone output with driving capability up to 125mW
- Transient suppression filter during power up and power down
- Balanced/unbalanced stereo line outputs with 1 k Ω driving capability

2 Pinout

Figure 1. Pin assignment

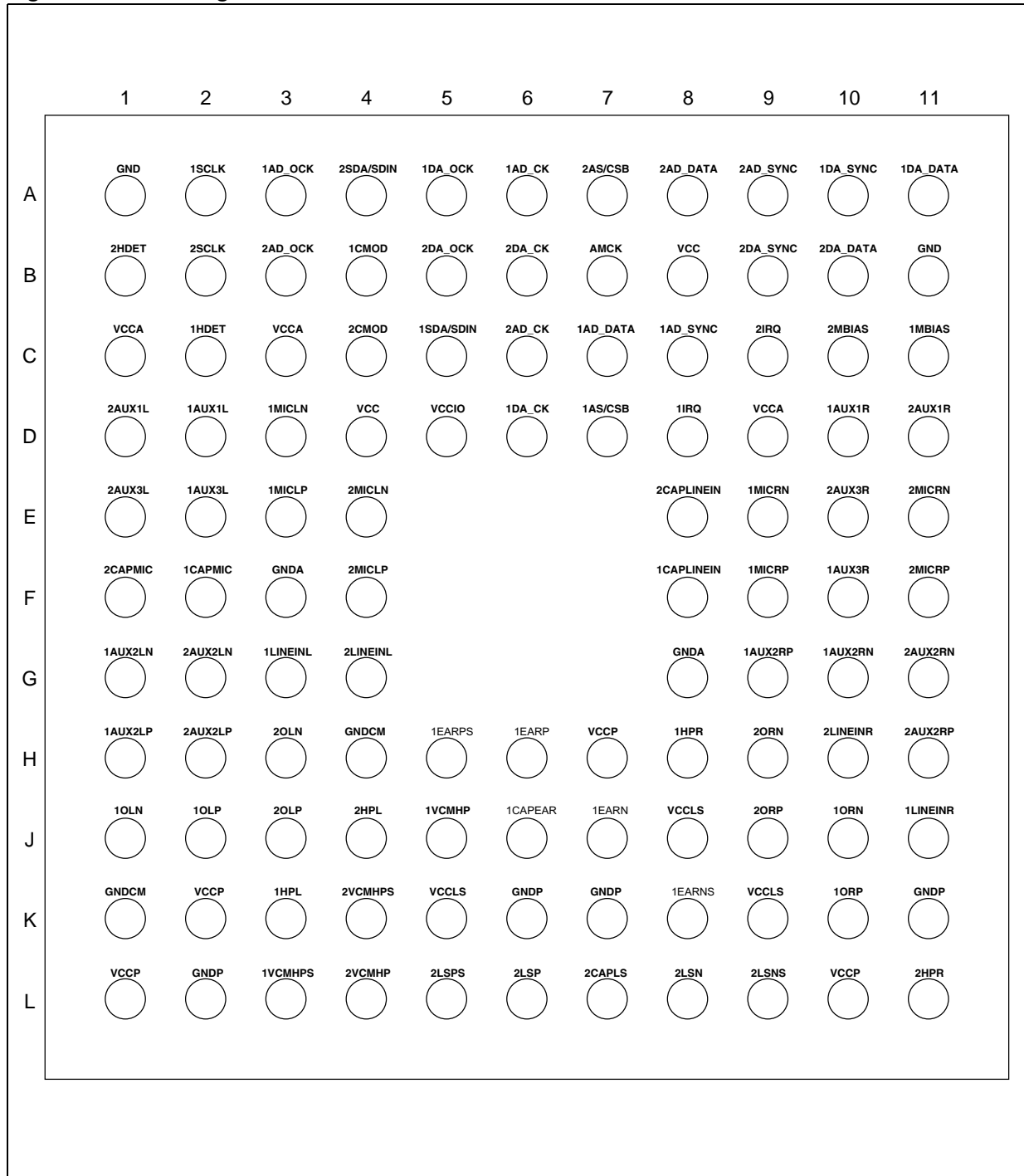

Table 1. STw5098 pin description

Position	Type	Pin name	Description
A1	P	GND	Ground pin for the digital section
A2	DI	1SCLK	Control interface serial clock input
A3	DO	1AD_OCK	Oversampled clock out from AD clock generator
A4	DIOD	2SDA/SDIN	Control interface serial data input-output in I ² C mode (SDA), control interface serial data input in SPI mode (SDIN).
A5	DO	1DA_OCK	Oversampled clock out from DA clock generator
A6	DIO	1AD_CK	Serial data clock for stereo A/D converter
A7	DI	2AS/CSB	Control interface address select in I ² C mode (AS). Interface enable signal in SPI mode (CSB).
A8	DO	2AD_DATA	Serial data out for stereo A/D converter
A9	DIO	2AD_SYNC	Frame sync for stereo A/D converter
A10	DIO	1DA_SYNC	Frame sync for stereo D/A converter
A11	DI	1DA_DATA	Serial data In for stereo D/A converter
B1	AI	2HDET	Headset detection input (microphone plug-in and push-button detection)
B2	DI	2SCLK	Control interface serial clock input
B3	DO	2AD_OCK	Oversampled clock out from AD clock generator
B4	DI	1CMOD	Control interface type selector I ² C-bus mode or SPI mode
B5	DO	2DA_OCK	Oversampled clock out from DA clock generator
B6	DIO	2DA_CK	Serial data clock for stereo D/A converter
B7	DI AI	AMCK	Master clock input. Accepted range 4 MHz to 32 MHz. AMCK is a digital square wave AMCK is an analog sinewave (Section 10.2 on page 62)
B8	P	VCC	Power supply pin for the digital section. Operating range: from 1.71 V to 2.7 V
B9	DIO	2DA_SYNC	Frame sync for stereo D/A converter
B10	DI	2DA_DATA	Serial data in for stereo D/A converter
B11	P	GND	Ground pin for the digital section
C1	P	VCCA	Power supply pin for the analog section. Standard operating range: from 2.7V to 3.3V Low voltage (LV) range: from 2.4V to 2.7V
C2	AI	1HDET	Headset detection input (microphone plug-in and push-button detection)
C3	P	VCCA	Power supply pin for the analog section. Standard operating range: from 2.7V to 3.3V Low voltage (LV) range: from 2.4V to 2.7V
C4	DI	2CMOD	Control interface type selector I ² C-bus mode or SPI mode.

Table 1. STw5098 pin description

Position	Type	Pin name	Description
C5	DIOD	1SDA/SDIN	Control interface serial data input-output in I ² C mode (SDA). Control interface serial data input in SPI mode (SDIN).
C6	DIO	2AD_CK	Serial data clock for stereo A/D converter
C7	DO	1AD_DATA	Serial data out for stereo A/D converter
C8	DIO	1AD_SYNC	Frame sync for stereo A/D converter
C9	DO	2IRQ	Programmable interrupt output. Active low signal.
C10	AO	2MBIAS	Microphone biasing pin. Fixed voltage reference
C11	AO	1MBIAS	Microphone biasing pin. Fixed voltage reference
D1	AI	2AUX1L	Left and right channel single ended pins for microphone or line input
D2	AI	1AUX1L	Left and right channel single ended pins for microphone or line input
D3	AI	1MICLN	Left and right channel differential pins for microphone input
D4	P	VCC	Power supply pin for the digital section. Operating range: from 1.71V to 2.7V
D5	P	VCCIO	Power supply pin for the digital I/O buffers. Operating ranges: from 1.2V to 1.8V and from 1.71V to V _{CC}
D6	DIO	1DA_CK	Serial data clock for stereo D/A converter
D7	DI	1AS/CSB	Control interface address select in I ² C mode (AS) Interface enable signal in SPI mode (CSB)
D8	DO	1IRQ	Programmable interrupt output. Active low signal.
D9	P	VCCA	Power supply pin for the analog section. Standard operating range: from 2.7V to 3.3V Low voltage (LV) range: from 2.4V to 2.7V
D10	AI	1AUX1R	Left and right channel single ended pins for microphone or line input
D11	AI	2AUX1R	Left and right channel single ended pins for microphone or line input
E1	AI	2AUX3L	Left and right channel single ended pins for microphone or line input
E2	AI	1AUX3L	Left and right channel single ended pins for microphone or line input
E3	AI	1MICLP	Left and right channel differential pins for microphone input
E4	AI	2MICLN	Left and right channel differential pins for microphone input
E8	AI	2CAPLINEIN	A capacitor must be connected between CAPLINEIN and ground
E9	AI	1MICRN	Left and right channel differential pins for microphone input
E10	AI	2AUX3R	Left and right channel single ended pins for microphone or line input
E11	AI	2MICRN	Left and right channel differential pins for microphone input
F1	AI	2CAPMIC	A capacitor must be connected between CAPMIC and ground.
F2	AI	1CAPMIC	A capacitor must be connected between CAPMIC and ground
F3	P	GNDA	Ground pin for the analog section
F4	AI	2MICLP	Left and right channel differential pins for microphone input

Table 1. STw5098 pin description

Position	Type	Pin name	Description
F8	AI	1CAPLINEIN	A capacitor must be connected between CAPLINEIN and ground
F9	AI	1MICRP	Left and right channel differential pins for microphone input
F10	AI	1AUX3R	Left and right channel single ended pins for microphone or line input
F11	AI	2MICRP	Left and right channel differential pins for microphone input
G1	AI	1AUX2LN	Left and right channel differential pins for microphone or line input
G2	AI	2AUX2LN	Left and right channel differential pins for microphone or line input
G3	AI	1LINEINL	Left and right channel single ended pins for line input
G4	AI	2LINEINL	Left and right channel single ended pins for line input
G8	P	GNDA	Ground pin for the analog section
G9	AI	1AUX2RP	Left and right channel differential pins for microphone or line input.
G10	AI	1AUX2RN	Left and right channel differential pins for microphone or line input
G11	AI	2AUX2RN	Left and right channel differential pins for microphone or line input
H1	AI	1AUX2LP	Left and right channel differential pins for microphone or line input
H2	AI	2AUX2LP	Left and right channel differential pins for microphone or line input
H3	AO	2OLN	Audio differential line out amplifier for left and right channels. This outputs can drive up to 1k Ω resistive load. Can be used as single ended output.
H4	P	GNDCM	Ground pin for analog reference. GNDCM can be connected to GNDA
H5	AO	1EARPS	EARPS, EARNs (sense) pins must be connected on the application board to EARP, EARN pins respectively. The connection must be as close as possible to the pins.
H6	AO	1EARP	Analog differential loudspeaker amplifier output for left channel or right channel or the sum of both. This output can drive 50nF (with series resistor) or directly an earpiece transducer from 8 Ω to 32 Ω . Can deliver from 500mW to 125mW.
H7	P	VCCP	Power supply pin for the left and right output drivers (headphones and line-out). Operating range: from V_{CCA} to 3.3V
H8	AO	1HPR	Audio single ended headphones amplifier outputs for left and right channels. The outputs can drive 50nF (with series resistor) or directly an earpiece transducer of 16 Ω
H9	AO	2ORN	Audio differential line out amplifier for left and right channels. This outputs can drive up to 1k Ω resistive load. Can be used as single ended output.
H10	AI	2LINEINR	Left and right channel single ended pins for line input
H11	AI	2AUX2RP	Left and right channel differential pins for microphone or line input
J1	AO	1OLN	Audio differential line out amplifier for left and right channels. This outputs can drive up to 1k Ω resistive load. Can be used as single ended output.

Table 1. STw5098 pin description

Position	Type	Pin name	Description
J2	AO	1OLP	Audio differential line out amplifier for left and right channels. This outputs can drive up to 1k Ω resistive load. Can be used as single ended output.
J3	AO	2OLP	Audio differential line out amplifier for left and right channels. This outputs can drive up to 1k Ω resistive load. Can be used as single ended output.
J4	AO	2HPL	Audio single ended headphones amplifier outputs for left and right channels. The outputs can drive 50nF (with series resistor) or directly an earpiece transducer of 16 Ω
J5	AO	1VCMHP	Common mode voltage headphones output. The negative pins of headphones left and right speakers can be connected to this pin to avoid decoupling capacitors.
J6	AI	1CAPEAR	A capacitor can be connected between this node and ground
J7	AO	1EARN	Analog differential loudspeaker amplifier output for Left channel or Right channel or the sum of both. This output can drive 50nF (with series resistor) or directly an earpiece transducer from 8 Ω to 32 Ω ; It can deliver from 500mW to 125mW.
J8	P	VCCLS	Power supply pin for the mono differential output driver. Operating range: from V_{CCA} to 5.5V
J9	AO	2ORP	Audio differential line out amplifier for left and right channels. This outputs can drive up to 1k Ω resistive load. Can be used as single ended output.
J10	AO	1ORN	Audio differential line out amplifier for left and right channels. This outputs can drive up to 1k Ω resistive load. Can be used as single ended output.
J11	AI	1LINEINR	Left and right channel single ended pins for line input
K1	P	GNDCM	Ground pin for analog reference. GNDCM can be connected to GNDA
K2	P	VCCP	Power supply pins for the left and right output drivers (headphones and line-out). Operating range: from V_{CCA} to 3.3V
K3	AO	1HPL	Audio single ended headphones amplifier outputs for left and right channels. The outputs can drive 50nF (with series resistor) or directly an earpiece transducer of 16 Ω
K4	AO	2VCMHPS	VCMHPS (sense) pin must be connected on the application board to VCMHP pin. The connection must be as close as possible to the pins.
K5	P	VCCLS	Power supply pin for the mono differential output driver. Operating range: from V_{CCA} to 5.5V
K6	P	GNDP	Ground pin for the left, right and mono-differential output drivers. GNDP and GNDA must be connected together.
K7	P	GNDP	Ground pin for the left, right and mono-differential output drivers. GNDP and GNDA must be connected together.

Table 1. STw5098 pin description

Position	Type	Pin name	Description
K8	AO	1EARNs	EARPS, EARNs (sense) pins must be connected on the application board to EARP, EARN pins respectively. The connection must be as close as possible to the pins.
K9	P	VCCLS	Power supply pins for the mono differential output driver. Operating range: from V_{CCA} to 5.5V
K10	AO	1ORP	Audio differential line out amplifier for left and right channels. This outputs can drive up to 1k Ω resistive load. Can be used as single ended output.
K11	P	GNDP	Ground pin for the left, right and mono-differential output drivers. GNDP and GNDA must be connected together.
L1	P	VCCP	Power supply pin for the left and right output drivers (headphones and line-out). Operating range: from V_{CCA} to 3.3V
L2	P	GNDP	Ground pin for the left, right and mono-differential output drivers. GNDP and GNDA must be connected together.
L3	AO	1VCMHPS	VCMHPS (sense) pin must be connected on the application board to VCMHP pin. The connection must be as close as possible to the pins.
L4	AO	2VCMHP	Common mode voltage headphones output. The negative pins of headphones left and right speakers can be connected to this pin to avoid decoupling capacitors.
L5	AO	2LSPS	LSPS, LSNS (sense) pins must be connected on the application board to LSP, LSN pins respectively. The connection must be as close as possible to the pins.
L6	AO	2LSP	Analog differential loudspeaker amplifier output for Left channel or Right channel or the sum of both. This output can drive 50nF (with series resistor) or directly an earpiece transducer of 8 Ω ; It can deliver up to 500mW.
L7	AI	2CAPLS	A capacitor can be connected between this node and ground
L8	AO	2LSN	Analog differential loudspeaker amplifier output for Left channel or Right channel or the sum of both. This output can drive 50nF (with series resistor) or directly an earpiece transducer of 8 Ω Can deliver up to 500mW.
L9	AO	2LSNS	LSPS, LSNS (sense) pins must be connected on the application board to LSP, LSN pins respectively. The connection must be as close as possible to the pins.
L10	P	VCCP	Power supply pin for the left and right output drivers (headphones and line-out). Operating range: from V_{CCA} to 3.3V
L11	AO	2HPR	Audio single ended headphones amplifier outputs for left and right channels. The outputs can drive 50nF (with series resistor) or directly an earpiece transducer of 16 Ω

Type definitions

AI	-	Analog input
AO	-	Analog output
AIO	-	Analog input output
DI	-	Digital input
DO	-	Digital output
DIO	-	Digital input output
DIOD	-	Digital input output open drain
P	-	Power supply or ground

3 Block diagram

Figure 2. STw5098 block diagram

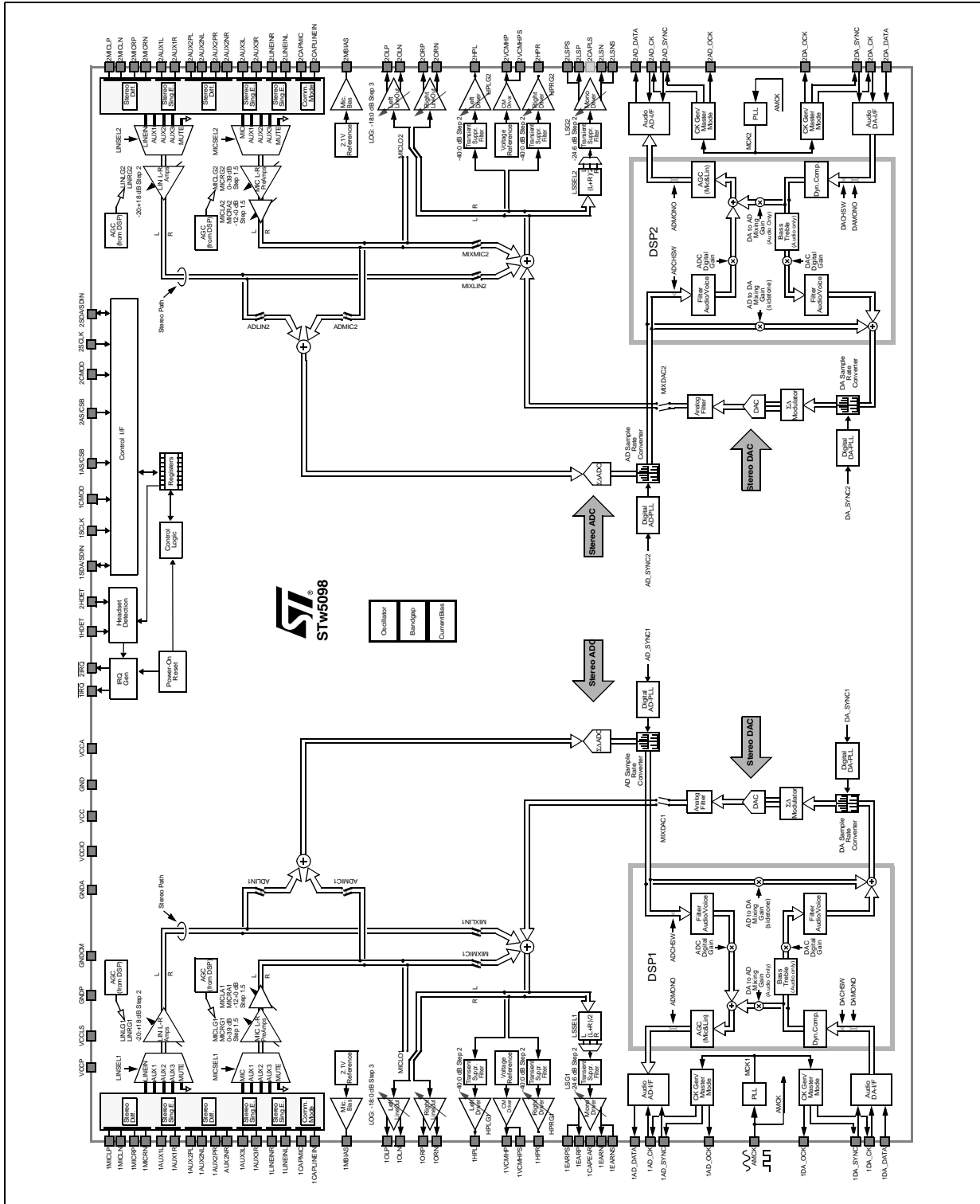

4 Functional description

4.1 Naming convention

The STw5098 is composed of two identical entities, with their respective set of control registers.

Regarding the pin labelling, a pin name preceded by 1 refers to entity 1 and a pin name preceded by 2 refers to entity 2 (ie.g. 1SCLK, 2SCLK). In the following sections, no distinction is made between the two entities when it is not relevant. Consequently, the 1 and 2 prefixes for entities 1 and 2 respectively are omitted. The same naming convention applies to the control registers (CRxxx).

4.2 Power supply

STw5098 can have different supply voltages for different blocks, to optimize performance, power consumption and connectivity. See [Section 9.2 on page 59](#) for voltage definition.

The correct sequence to apply supply voltage is to set first (and unset last) the digital I/O supply (V_{CCIO}). The other supply voltages can be set in any order and can be disconnected individually, if needed. Disconnection does not cause any harm to the device and no extra current is pulled from any supply during this operation. Moreover if a voltage conflict is detected, like $V_{CCA} < V_{CC}$ (not allowed), simply all blocks connected to V_{CCA} are set to power down and no extra current is pulled from supply.

When V_{CCIO} is set and V_{CC} (digital supply) is not set, all the digital output pins are in high impedance state, while the digital inputs are disconnected to avoid power consumption for any input voltage value between GND and V_{CCIO} . Before V_{CC} is disconnected the device has to be reset (SWRES bit in CR30).

When the analog supply (V_{CCA}) is set and V_{CC} is not set, all the analog inputs are in high impedance state.

The two sets of control registers are powered by VCC pins (digital supply) so if these pins are disconnected all the information stored in control registers is lost. When the digital supply voltage is set, a power-on-reset (POR) circuit sets all the registers content to the default value and then generates IRQ signals writing 1 in bits PORMSK end POREV in CR31 and CR32 respectively for both entities.

All supplies must be on during operation.

4.3 Device programming

STw5098 can be programmed by writing Control Registers with SPI or I²C compatible control interface (both slave). The interface is always active, there is no need to have the master clock running to program the device registers. The control interfaces of each entity can be operated independently either in SPI or I2C modes.

The choice between the two interfaces for each entity is done via their input pins 1CMOD and 2CMOD (CMOD):

1. CMOD connected to GND: I²C compatible mode selected
The device address is selected with AS pin:

AS/CSB connected to GND: chip address 00110101(35hex) for reading, 00110100 (34hex) for writing

AS/CSB connected to V_{CCIO}: chip address 00110111(37hex) for reading, 00110110 (36hex) for writing

When this mode is selected control registers are accessed through pins:

SCLK (clock)

SDA (serial data out/in, open drain)

2. CMOD connected to V_{CCIO}: SPI compatible mode selected
When this mode is selected control registers are accessed through:
AS/CSB (chip select, active low)
SCLK (clock)
SDIN (serial data in)
AD_OCK or DA_OCK or IRQ (serial data out, if selected)

Device Programming: I²C. The I²C Control Interface timing is shown in [Section 6.1 on page 50](#). The interface has an internal counter that keeps the current address of the control register to be read or written. At each write access of the interface the address counter is loaded with the data of the *register address* field. The value in the address counter is increased after each data byte read or write. It is possible to access the interface in 2 modes: single-byte mode in which the address and data of a single register are specified, and multi-byte mode in which the address of the first register to be written or read is specified and all the following bytes exchanged are the data of successive registers starting from the one specified (in multi-byte mode the internal address counter restart from register 0 after the last register 36). Using the multi-byte mode it is possible to write or read all the registers with a single access to the device on the I²C bus. This applies to both entities of the device.

Device Programming: SPI. The SPI Control Interface timing is shown in section [Section 6.2 on page 51](#). Bits SPIOSEL (SPI Output Select) in CR33 control the out pin selection for serial data out (none, AD_OCK, DA_OCK or IRQ), while bit SPIOHIZ=1 in CR33 selects the high impedance state of serial data out pin when idle. The first bit sent on SDIN, after AS/CSB falling edge, sets the interface for writing (SDIN=1) or reading (SDIN=0), then a 7-bit Control Register address follows.

If the interface is set for writing then the last 8 bits on SDIN are written in the control register. If the interface is set for reading then after the 7 bit address STw5098 sends out 8 bits data on the pin selected with bits SPIOSEL in CR33, while bits present at SDIN pin are ignored. If SPIOSEL=00 (no out pin selected) the reading access on SPI interface can still be useful to clear the IRQ event bits in CR32.

4.4 Power up

STw5098 internal blocks can individually be switched on and off according to the user needs. A general power-up bit is present at bit 7 of CR0. The output drivers should always be powered up after the general power up. See the following drawing to select the needed block for the desired function. A fast-settling function is activated to quickly charge external capacitors when the device is switched on (CAPLS, CAPLINEIN and CAPMIC).

Figure 3. Power up block diagram: example shown for one entity

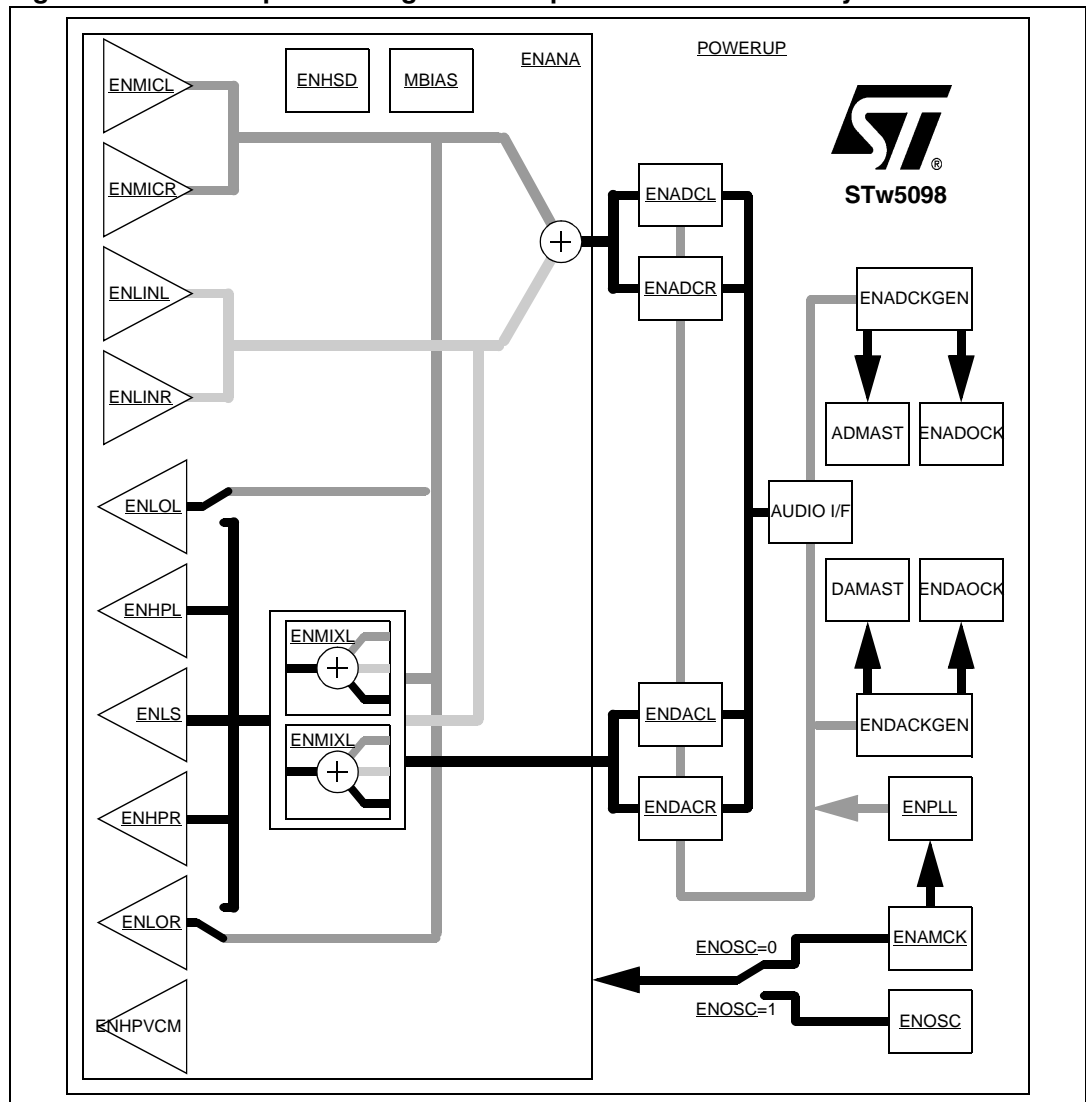

4.5 Master clock

Master clock is applied to both entities. The master clock pin (AMCK) accepts any frequency from 4 MHz to 32 MHz. The 4-32 MHz range is divided in sub-ranges that have to be programmed in bits CKRANGE in CR30. The jitter and spectral properties of this clock have a direct impact on the DAC and ADC performance because it is used to directly or by integer division drive the continuous-time to sampled-time interfaces.

Note that AMCK clock does not need to have any relation to any other digital or analog input or output.

AMCK can be either a square wave or a sinewave, bit AMCKSIN in CR30 selects the proper input mode. When a sinewave is used as input, AMCK pin must be decoupled with a capacitor. Specification for sinusoid input can be found in [Section 10.2 on page 62](#).

The AMCK clock is not needed when only analog functions are used. For this purpose an internal oscillator with no external components can be used to operate the device (see [Section 4.14 on page 25](#)).

4.6 Data rates

STw5098 supports any data rate in 2 ranges: 8 kHz to 48 kHz and 88 kHz to 96 kHz. The range is selected with bits DA96K and AD96K in CR29 for AD and DA paths respectively.

Note: When AD96K=1 it is required to have DA96K=1.

The rates are fully independent in A/D and D/A paths. Moreover the rates do not have to be specified to the device and they can change on the fly, within one range, while data is flowing.

The 2 audio data interfaces (for A/D and D/A) can independently operate in master or slave modes.

4.7 Clock generators and master mode function

STw5098 provides 4 internal clock generators that can drive, if needed, the audio interfaces (master mode), and/or two independent master clocks.

The AMCK clock input frequency is internally raised via a PLL on each entity to obtain a clock (MCK) in the range 32 MHz to 48 MHz. The ratio MCK/AMCK is defined in CR30 (see MCKCOEFF in [Section 4.7 on page 20](#)).

MCK is used to obtain, by fractional division, the oversampled clock (OCK), word clock (SYNC) and bit clock (CK), that will therefore have edges aligned with MCK (the OCK period can have jitter of 1 MCK period).

The frequency of OCK, SYNC and CK is set with DAOCKF in CR21/20 for DA interface, and ADOCKF in CR24/23 for AD interface.

The ratio between OCK and SYNC clocks is selected with bit DAOCK512 in CR22 for DA interface and bit ADOCK512 in CR25 for AD interface. The ratio between CK and SYNC clocks depends on the selected interface format (see [Audio digital interfaces](#) paragraph below). Note that SPI format can only be slave.

The ADOCK and DAOCK output clocks are activated by bits ENADOCK and ENDAOCK respectively, while master mode generation is activated with two bits: first ADMAST (DAMAST) sets ADSYNC and ADCK (DASYNC and DACK) pins as outputs, then ADMASTGEN (DAMASTGEN) generates the SYNC and CK clocks. The logical value at SYNC and CK pins before data generation depends on the interface selected format.

See description of CR20 to CR25 for further details.

4.8 Audio digital interfaces

Four separate audio data interfaces are provided for AD and DA paths to have maximum flexibility in communicating with other devices. The 4 interfaces can have different rates and can work in different formats and modes (i.e an AD interface can be 8 kHz PCM slave while a DA is 44.1 kHz I²S master).

The pins used by the interfaces are:

AD_SYNC, AD_CK and AD_DATA for AD paths word clock, bit clock and data, respectively, and

DA_SYNC, DA_CK and DA_DATA for DA paths word clock, bit clock and data, respectively.

Data is exchanged with MSB first and left channel data first in all formats. Data word-length is selected with bits DAWL in CR26 and ADWL in CR27. AD_DATA pin, outside the selected time slot, is in the impedance condition selected by bit ADHIZ in CR28 in all data formats except right aligned format.

In the following paragraphs SYNC, CK and DATA will be used when the distinction between AD and DA is not relevant. When Master Mode is selected (bits DAMAST and ADMAST in CR22 and CR25 respectively) the SYNC and CK clocks are generated internally. In addition, an oversampled clock can be generated for each interface (AD_OCK and DA_OCK). The clock is available in Slave Mode also, if needed.

The AD and DA interfaces can also be used as a single bidirectional interface when they are configured with the same format (Delayed, DSP, etc.) and AD_SYNC is connected to DA_SYNC and DA_CK to AD_CK. Master Mode is still available selecting ADMAST or DAMAST (not both).

The interfaces features are controlled with control registers CR26, CR27 and CR28.

Supported operating formats:

- **Delayed format (I²S compatible)** (DAFORM or ADFORM =000): the Audio Interface is I²S compatible ([Figure 9 on page 54](#)). The number of CK periods within one SYNC period is not relevant, as long as enough CK periods are used to transfer the data and the maximum frequency limit specified for bit clock is not exceeded. CK can be either a continuous clock or a sequence of bursts. In master mode there are 32 CK periods per SYNC period (that means 16 CK periods per channel) when the word length is 16 bit, while there are 64 CK periods per SYNC period (or 32 CK periods per channel) when word length is 18bit or higher. Bits ADSYNCP, DASYNCP and ADCKP, DACKP affect the interface format inverting the polarity of SYNC and CK pins respectively.
- **Left aligned format** (DAFORM or ADFORM =001): this format is equivalent to delayed format without the 1 bit clock delay at the beginning of each frame ([Figure 9 on page 54](#)).
- **Right aligned format** (DAFORM or ADFORM =010): this format is equivalent to delayed format, except that the audio data is right aligned and that the number of CK periods is fixed to 64 for each SYNC period ([Figure 9 on page 54](#)).
- **DSP format** (DAFORM or ADFORM =011) in this format the audio interface starting from a frame sync pulse on SYNC receives (DA) or sends (AD) the left and right data one after the other ([Figure 10 on page 55](#)). The number of CK periods within one SYNC period is not relevant, as long as enough CK periods are used to transfer the data and the maximum frequency limit specified for bit clock is not exceeded. CK can be either a continuous clock or a sequence of bursts. In Master Mode there are 32 CK periods per SYNC period when the word length is 16 bit, while there are 64 CK periods per SYNC period when word length is 18bit or higher. Bit CKP (ADCKP and DACKP)

affects the interface format inverting the polarity of CK pin. Bit SYNCP (ADSYNCP and DASYNCP) switches between delayed (SYNCP=0) and non delayed (SYNCP=1) formats.

DSP format is suited to interface with a multi-channel serial port.

- **SPI format** (DAFORM or ADFORM =100) in this format left and right data is received with separate data burst. Every burst is identified with a low level on SYNC signal ([Figure 10 on page 55](#)). There is no timing difference between the left and right data burst: the two channels are identified by the startup order: the first burst after AD path or DA path power-up identifies the left channel data, the second one is the Right channel data, then left and right data repeat one after the other. CK must have 16 periods per channel in case of 16 bit data word and 32 periods per channel in case of 18 bit to 32 bit data word.
The SPI interface can be configured as a single-channel (mono) interface with bit SPIM (ADSPIM and DASPIM). The mono interface always exchanges the left channel sample.
SPI-format can only be slave: if Master Mode is selected the CK and SYNC pins are set to 0. Bit CKP (ADCKP and DACKP) affects the interface format inverting the polarity of CK pin.
- **PCM format** (DAFORM or ADFORM =111): this format is monophonic, as it can only receive (DA) and transmit (AD) single channel data ([Figure 10 on page 55](#)). It is mainly used when voice filters are selected. If audio filters are used then the same sample is sent from DA-PCM interface to both channel of DA path, and the left channel sample from AD path is sent to AD-PCM interface. If in the AD path the right channel has to be sent to the PCM interface then the following must be set: ADRTOL=1 (CR27) and ENADCR=0 (CR1). In Master Mode the number of CK periods per SYNC period is between 16 and 512 (see DAPCMF in CR22 and ADPCMF in CR25 [Section 4.7 on page 20](#) for details). Bit CKP (ADCKP and DACKP) affects the interface format inverting the polarity of CK pin. Bit SYNCP (ADSYNCP and DASYNCP) switches between delayed (SYNCP=0) and non delayed (SYNCP=1) formats.

4.9 Analog inputs

Each entity of the STw5098 has a stereo Microphone preamplifier and a stereo Line In amplifier, with inputs selectable among 5: MIC (for Microphone preamplifiers only), LINEIN (for Line In amplifiers only) and 3 different AUX inputs (for Microphone and Line In amplifiers). The AUX inputs can be used simultaneously for Line In amplifiers and Microphone preamplifiers.

The following description is for one entity, it is similar for the other entity.

- **Microphone preamplifier:** it has a very low noise input, specifically designed for low amplitude signals. For this reason the preamplifier has a high input gain (up to 39 dB) keeping a constant 50 k Ω input impedance for the whole gain range. However it can also be used as line in preamplifier because it can accept a high dynamic input signal (up to 4 V_{pp}). There are two separate gain and attenuation stages in order to improve the S/N ratio when the preamplifier output range is below full scale (volume control). The gain and attenuation controls are separate for left and right channel (CR3 and CR4 respectively). The Preamplifier input is selected with bits MICSEL in CR18, and it is disconnected when MICMUTE=1. If a single ended input is selected then the preamplifier uses the selected pin as the positive input and connects the negative input (for both left and right channels) to CAPMIC pin, which has to be connected through a capacitor to a low noise ground (typically the same reference ground of the input).

Each stereo Microphone preamplifier is powered up with bits ENMICL and ENMICR in CR1.

- **Line In amplifier:** each line in amplifier is designed for high level input signal. The input gain is in the range -20 dB up to 18 dB. The Line In amplifier input is selected with bits LINSEL in CR18, and it is disconnected when LINMUTE=1. If a single ended input is selected then the amplifier uses the selected pin as the positive input and connects the negative input (for both left and right channels) to CAPLINEIN pin, which has to be connected through a capacitor to a low noise ground (typically the same reference ground of the input).
The stereo Line In amplifier is powered up with bits ENLINL and ENLINR in CR1.

4.10 Analog output drivers

Each entity of the STw5098 provides 3 different analog signal outputs and 1 common mode reference output. The description here below is for one entity. V_{CCP} and V_{CCL} are common for both entities.

- **Line out drivers:** it is a stereo differential output, it can be used as single-ended output just by using the positive or negative pin. It can drive 1 k Ω resistive load. The load can be connected between the positive and negative pins or between one pin and ground through a decoupling capacitor. The output gain is regulated with LOG bits in CR7, in the range 0 to -18 dB, simultaneously for left and right channels. When used as a single ended output the effective gain is 6 dB lower. It is muted with bit MUTELO in CR19. The input signal of this stereo output can come from the analog mixer or directly from MIC preamplifiers. The output Common Mode Voltage level is controlled with bits VCML in CR19. The supply voltage of line out drivers is V_{CCP} .
The line out drivers are powered up with bits ENLOL and ENLOR in CR1. The output pins are in high impedance state with a 180k Ω pull-down resistor when the line out drivers are powered down.
- **Headphones drivers:** it is a stereo single ended output. It can drive 16 ohm resistive load and deliver up to 40 mW. The output gain is regulated with HPLG and HPRG bits in CR8 and CR9 respectively, with a range of -40 to 6 dB. It is muted with bit MUTEHP in CR19. The input signal of this stereo output comes from the analog mixer. The output common mode voltage is controlled with bits VCML in CR19. The supply voltage of headphones drivers is V_{CCP} .
The headphones drivers are powered up with bits ENHPL and ENHPR in CR2. The output pins are in high impedance state when the headphones drivers are powered down.
- **Common mode voltage driver:** it is a single ended output with output voltage value selectable with bits VCML in CR19, from 1.2 V to 1.65 V in steps of 150 mV. The output voltage should be set to the value closest to $V_{CCP}/2$ to optimize output drivers performance. The common mode voltage driver is designed to be connected to the common pin of stereo headphones, so that decoupling capacitors are not needed at HPL and HPR outputs. The supply voltage of the common mode voltage driver is V_{CCP} .
The common mode voltage driver is powered up with bit ENHPVCM in CR2. The output pin is in high impedance state when the common mode voltage driver is powered down.

- **Loudspeaker driver (one entity only):** it is a monophonic differential output. It can drive 8 Ω resistive load and deliver up to 500 mW to the load. The output gain is regulated with LSG bits in CR7, in the range -24 to +6 dB. The input signal of the loudspeaker driver comes from the analog mixers: bits LSSEL in CR29 select left channel, right channel, (L+R)/2 (mono) or mute. The output common mode voltage is obtained with an internal voltage divider from V_{CCLS} and it is connected to CAPLS pin. The supply voltage of the loudspeaker driver is V_{CCLS} . The loudspeaker driver is powered up with bit ENLS in CR2. The output pin is in high impedance state when the loudspeaker driver is powered down.

Note: 1 Together with the LS driver, only a second power output is allowed among:
 Ear (1EARP - 1EARN)
 Headphones 1 (1HPL and 1HPR)
 Headphones 2 (2HPL and 2HPR)

- **Earphone driver (one entity only):** it is a monophonic differential output. It can drive 32 Ω resistive load and deliver up to 125 mW to the load. The output gain is regulated with EARG bits in CR7, in the range -24 to +6 dB. The input signal of the loudspeaker driver comes from the analog mixers: bits EARSEL in CR29 select left channel, right channel, (L+R)/2 (mono) or mute. The output Common Mode Voltage is obtained with an internal voltage divider from V_{CCLS} and it is connected to CAPEAR pin. The supply voltage of the loudspeaker driver is V_{CCLS} . The loudspeaker driver is powered up with bit ENEAR in CR2. The output pin is in high impedance state when the loudspeaker driver is powered down.

Note: **Note on direct connection of V_{CCLS} to the battery:**
 The voltage of batteries of handheld devices during charging is usually below 5.5 V, making V_{CCLS} supply pin suitable for a direct connection to the battery. In this case if STw5098 is delivering the maximum power to the load and the ambient temperature is above 70 °C then the simultaneous charging of the battery can overheat the device. A basic protection scheme is implemented in STw5098 (activated with bit LSLIM in CR19): it limits the maximum gain of the loudspeaker to -6 dB when V_{CCLS} is above 4.2 V, and it removes the limit for V_{CCLS} below 4.0 V. The loudspeaker gain is left unchanged if it is set below -6 dB with bits LSG. This event ($V_{CCLS} > 4.2$ V) can generate, if enabled (bit VLSSMSK in CR31), an IRQ signal.

4.11 Analog mixers

STw5098 can send to the output drivers the sum of stereo audio signals from 3 different sources of each entity: DA path (bit MIXDAC in CR17), Microphone Preamplifiers (bit MIXMIC in CR17) and Line In Amplifiers (bit MIXLIN in CR17). The analog mixers do not have a gain control on the inputs, therefore the user should reduce the levels of the input signals within the analog signal range.

The stereo analog mixers are powered up with bits ENMIXL and ENMIXR in CR2.

4.12 AD paths

In each entity the AD path converts audio signals from Microphone Preamplifiers (selected with bit ADMIC in CR17) and Line In Amplifiers (bit ADLIN in CR17) inputs to digital domain. If both inputs are selected then the sum of the two is converted. After AD conversion the audio data is resampled with a sample rate converter and then processed with the internal DSP. Two different filters are selectable in the DSP (bit ADVOICE in CR29): stereo Audio

Filter, with DC offset removal and FIR image filtering; and a standard mono voice-channel filter (uses left channel input and feeds both channel output). The AD path includes a digital gain control (ADCLG, ADCRG in CR12 and CR13 respectively) in the range -57 to +8 dB. The maximum gain from Mic Preamplifier to AD interface is then 47 dB. When Audio filter is selected in both AD and DA paths then DA audio data can be summed to AD data and sent to the AD Audio Interface (see DA2ADG in CR15). Left and right channels can be independently switched on and off to save power, if needed (bits ENADCL and ENADCR in CR1)

4.13 DA paths

In each entity the DA path converts digital data from the digital audio interface to analog domain and feeds it to the analog mixer. Incoming audio data is processed with a DSP where different filters are selectable (bit DAVOICE in CR29): Audio filter, stereo, with FIR image filtering, bass and treble controls (bits BASS and TREBLE in CR14), de-emphasis filter; and a standard voice channel filter, mono (uses left channel input and feeds both channel output). A dynamic compression function is available for both audio and voice filters (bit DYNC in CR14). The DA path includes a digital gain control (DACLG, DACRG in CR10 and CR11 respectively) in the range -65 to 0 dB. AD to DA mixing (sidetone) can be enabled: see CR16 for details. Left and right channel can be independently switched on and off to save power, if needed (bits ENACL and ENACR in CR1).

4.14 Analog-only operations

Each entity from the STw5098 can operate without AMCK master clock if analog-only functions are used. It is possible to mix Microphone and Line In preamplifiers signals and listen through headphones, loudspeaker or send them to line-out. The analog-only operation is enabled with bit ENOSC in CR0. When ENOSC=1 the AD and DA paths cannot be used.

In Analog Mode, each of the two entities can handle two different stereo audio signals, so it can be used as a front end for an external voice codec that does not include microphone preamplifiers and power drivers: mic signal is sent through Microphone preamplifiers directly to line out drivers (Transmit path), while Receive signal is sent through Line In amplifiers to the selected power drivers.

4.15 Automatic Gain Control (AGC)

STw5098 provides a digital Automatic Gain Control in AD path for each entity. The circuit can control the input gain at MIC preamplifier, Line In amplifier or both (bits ENAGCMIC and ENAGCLIN in CR35). When one input is selected, the center gain value used for the input is fixed with bits MICLG, MICRG, LINLG and LINRG in CR3 to CR6 (like in normal operation), then the AGC circuit adds to all the gains a value in the range -10.5 dB to +10.5 dB (or, extended with bit AGCRANGE in CR35, -21 dB to 21 dB), in order to obtain an average level at the digital interface output in the range -6 dB to -30 dB (selected with bits AGCLEV in CR35). The AGC added gain acts directly in the input gain, to avoid input saturation and improve S/N ratio, so it cannot exceed the input gain range. When MIC and Line-In inputs are selected simultaneously the control is performed on the sum of the two, preserving the balance fixed with input gains. Different values for Attack and Decay constants can be selected, depending on the kind of signal the AGC has to control (i.e. voice, music). The

Attack and Decay time constants are related to the AD data rate (see bits AGCATT and AGCDEL in CR34).

4.16 Interrupt request: IRQ pins

On each entity of the STw5098, the interrupt request feature can signal to a control device the occurrence of particular events on each entity. Two control registers are used to choose the behavior of IRQ pin: the first is a Status/Event Register (CR32), where bits can represent the status of an internal function (i.e. a voltage is above or below a threshold) or an event (i.e. a voltage changed crossing a threshold); the second is a Mask Register (CR31) where if a bit in the mask is set to 1 then the corresponding bit in the Status/Event Register can affect IRQ pin status.

On each entity, the IRQ pin is always active low. At V_{CC} power up an interrupt request is generated by the Power-On-Reset circuit that sets to 1 bits PORMSK in CR31 and POREV in CR32. After this event the PORMSK bit should be cleared by the user and bit IRQCMOS in CR33 should be set according to the application (open drain or CMOS).

When an IRQ event occurs and SPI control interface is selected with no serial output pin it is still possible to identify the event (and relative status) that generated the interrupt request. This can be done by setting the IRQ mask/enable bits (in CR31) one at the time (with successive writings) and reading the IRQ pin status. A simple example of this is the headset plug-in detection: at first we set bit HSDETMSK=1 in CR31 (with all the other bits set to 0). If there is an interrupt request then we set HSDETMSK=0 and HSDETEN=1, so we can read the HSDET status at IRQ pin. Then we read CR32 to clear its content (even if no data is sent out).

4.17 Headset plug-in and push-button detection

Each entity of the STw5098 can detect the plug-in of a microphone connector and the press/release event of a call/answer push-button. An application example can be found below, while specifications can be found in [Section 10.4 on page 64](#).

Figure 4. Plug-in and push-button detection application note

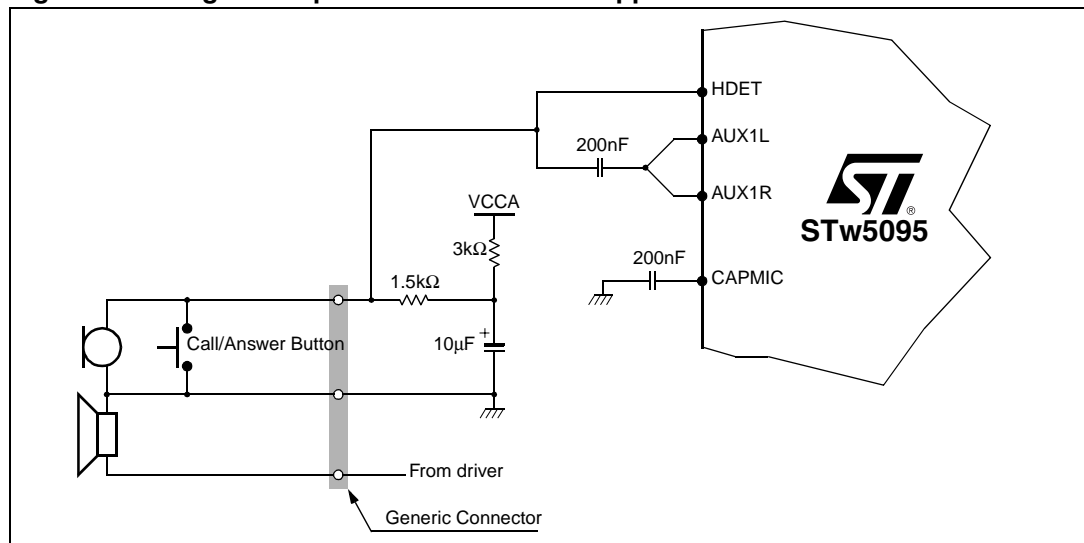

4.18 Microphone biasing circuits

The Microphone Biasing Circuits can drive mono or stereo microphones and can switch them off when not needed in order to save the current used by the microphone biasing network on each entity. Two bits control the behavior of the microphone bias circuit: MBIAS in CR17 enables the circuit (fixed voltage at MBIAS pin), while bit MBIASPD in CR17 affects the behavior of MBIAS pin when the function is not enabled. In particular when MBIASPD=1 the MBIAS pin is pulled down, otherwise it is left in tristate mode. The specification for the microphone biasing circuits can be found in [Section 10.6 on page 64](#).

5 Control registers

5.1 Summary

Table 2. Control register summary

CR# (hex)	Description	D7	D6	D5	D4	D3	D2	D1	D0	Def.
CR0 (00h)	Supply & power control #1	POWER UP	ENANA	ENAMCK	ENOSC	ENPLL	ENHSD	A24V	D12V	0000 0000
CR1 (01h)	Power control #2	ENADCL	ENADCR	ENDACL	ENDACR	ENMICL	ENMICR	ENLINL	ENLINR	0000 0000
CR2 (02h)	Power control #3	ENLOL	ENLOR	ENHPL	ENHPR	ENHPVCM	1ENEAR 2ENLS	ENMIXL	ENMIXR	0000 0000
CR3 (03h)	Mic gain left	MICLA(2:0)			MICLG(4:0)				0000 0000	
CR4 (04h)	Mic gain right	MICRA(2:0)			MICRG(4:0)				0000 0000	
CR5 (05h)	Line in gain left	X	X	X	LINLG(4:0)				0000 1001	
CR6 (06h)	Line in gain right	X	X	X	LINRG(4:0)				0000 1001	
CR7 (07h)	LO gain & LS gain	X	LOG(2:0)			1EARG(3:0) 2LSG(3:0)		0000 0011		
CR8 (08h)	HPL gain	X	X	X	HPLG(4:0)				0000 0011	
CR9 (09h)	HPR gain	X	X	X	HPRG(4:0)				0000 0011	
CR10 (0Ah)	DAC digital gain left	X	X	DACLG(5:0)				0000 0000		
CR11 (0Bh)	DAC digital gain right	X	X	DACRG(5:0)				0000 0000		
CR12 (0Ch)	ADC digital gain left	X	X	ADCLG(5:0)				0000 1000		
CR13 (0Dh)	ADC digital gain right	X	X	ADCRG(5:0)				0000 1000		
CR14 (0Eh)	Bass/treble/de-emphasis	DYNC	TREBLE(2:0)			BASS(3:0)			0000 0000	
CR15 (0Fh)	DA to AD mixing gain	X	X	X	DA2ADG(4:0)				0000 0000	
CR16 (10h)	AD to DA mix/sidetone gain	X	X	AD2DAG(5:0)				0000 0000		
CR17 (11h)	Mixer switches & mic bias	MBIAS	MBIASPD	ADMIC	ADLIN	MIXMIC	MIXLIN	MIXDAC	MICLO	0000 0000

Table 2. Control register summary

CR# (hex)	Description	D7	D6	D5	D4	D3	D2	D1	D0	Def.
CR18 (12h)	Input switches	X	IN2VCM	LINMUTE	LINSEL(1:0)		MICMUTE	MICSEL(1:0)		0010 0100
CR19 (13h)	Drivers control	VCML(1:0)		X	MUTELO	MUTEHP	1EARLIM 2LSLIM	1EARSEL(1:0) 2LSSEL(1:0)		0101 1000
CR20 (14h)	DAOCK frequency LSB	DAOCKF(7:0)								0000 0000
CR21 (15h)	DAOCK frequency MSB	DAOCKF(15:8)								0000 0000
CR22 (16h)	DA clock generator control	X	X	DAMAST	DA MASTGEN	END AOCK	DAO CK512	DAPCMF(1:0)		0000 0000
CR23 (17h)	ADOCK frequency LSB	ADOCKF(7:0)								0000 0000
CR24 (18h)	ADOCK frequency MSB	ADOCKF(15:8)								0000 0000
CR25 (19h)	AD Clock generator control	X	X	ADMAST	AD MASTGEN	ENA DOCK	ADO CK512	ADPCMF(1:0)		0000 0000
CR26 (1Ah)	DAC data IF control	X	DAFORM(2:0)			DASPIM	DAWL(2:0)			0000 0000
CR27 (1Bh)	ADC data IF control	ADRTOL	ADFORM2:0)			ADSPIM	ADWL(2:0)			0000 0000
CR28 (1Ch)	DAC&ADC data IF control	AMC KINV	DACKP	DASYNCP	DAMONO	ADCKP	AD SYNCP	ADMONO	ADHIZ	0000 0000
CR29 (1Dh)	Digital filters control	X	DAVOICE	DA96K	RXNH	ADVOICE	AD96K	ADNH	TXNH	0000 0000
CR30 (1Eh)	Soft reset & AMCK range	SWRES	X	X	X	AMCKSIN	CKRANGE(2:0)			0000 0000
CR31 (1Fh)	Interrupt mask	VLSHEN	PUSH BEN	HSDTEN	VLSHMSK	PUSH BMSK	HSDET MSK	OVFMSK	PORMSK	0000 0000
CR32 (20h)	Interrupt status	VLSH	PUSHB	HSDET	VLSHEV	PUSHBEV	HSDETE V	OVFEV	POREV	0000 0000
CR33 (21h)	Misc. control	X	X	SPIOHIZ	SPIOSEL(1:0)		IRQCMOS	OVFDA	OVFAD	0000 0000
CR34 (22h)	AGC attack/decay coeff.	AGCATT(3:0)				AGCDEC(3:0)				0000 0000
CR35 (23h)	AGC control	X	ENA GCLIN	ENAG CMIC	AGC RANGE	AGCLEV(3:0)				0000 0000
CR36 (24h)	RESERVED	X	X	X	X	X	X	X	X	0000 0000

Note: X reserved, write zero

Caution: In the following [Section 5: Control registers](#), reference to each entity is omitted. Each entity of the STw5098 has the same register set.

5.2 Supply and power control

CR# (hex)	Description	D7	D6	D5	D4	D3	D2	D1	D0	Def.
CR0 (00h)	Supply & power control #1	POWER UP	ENANA	ENAMCK	ENOSC	ENPLL	ENHSD	A24V	D12V	0000 0000
CR1 (01h)	Power control #2	ENADCL	ENADCR	ENDACL	ENDACR	ENMICL	ENMICR	ENLINL	ENLINR	0000 0000
CR2 (02h)	Power control #3	ENLOL	ENLOR	ENHPL	ENHPR	ENH PVCM	ENLS	ENMIXL	ENMIXR	0000 0000

Table 3. CR0 description

Bits	Name	Val.	CR0 description	Def.
7	POWERUP	1 0	All the enabled analog and digital blocks are in power up All the device is in power down	0
6	ENANA	1 0	The analog blocks can be enabled All the analog blocks are in power down	0
5	ENAMCK	1 0	AMCK clock input pin is enabled AMCK clock input pin is disabled	0
4	ENOSC	1 0	The Internal oscillator is enabled. The analog blocks use oscillator clock The internal oscillator is in power down	0
3	ENPLL	1 0	The PLL is enabled The PLL is in power down	0
2	ENHSD	1 0	The headset plug-in detector is enabled The headset plug-in detector is disabled	0
1	A24V	1 0	Analog supply pins voltage range is $2.4V < V_{CCA} < 2.7V$ Analog supply pins voltage range is $2.7V < V_{CCA} < 3.3V$	0
0	D12V	1 0	Digital I/O pin voltage range is $1.2V < V_{CCIO} < 1.8V$ Digital I/O pin voltage range is $1.71V < V_{CCIO} < V_{CC}$	0

Table 4. CR1 description

Bits	Name	Value	CR1 description	Def.
7	ENADCL	1	The left channel A/D converter is enabled	0
		0	The left channel A/D converter is in power down	
6	ENADCR	1	The right channel A/D converter is enabled	0
		0	The right channel A/D converter is in power down	
5	ENDACL	1	The left channel D/A converter is enabled	0
		0	The left channel D/A converter is in power down	
4	ENDACR	1	The right channel D/A converter is enabled	0
		0	The right channel D/A converter is in power down	
3	ENMICL	1	The left channel microphone preamplifier is enabled	0
		0	The left channel microphone preamplifier is in power down	
2	ENMICR	1	The right channel microphone preamplifier is enabled	0
		0	The right channel microphone preamplifier is in power down	
1	ENLINL	1	The left channel line-in preamplifier is enabled	0
		0	The left channel line-in preamplifier is in power down	
0	ENLINR	1	The right channel line-in preamplifier is enabled	0
		0	The right channel line-in preamplifier is in power down	

Table 5. CR2 description

Bit #	Name	Value	CR2 Description	Def.
7	ENLOL	1	The left channel line out driver is enabled	0
		0	The left channel line out driver is in power down (default)	
6	ENLOR	1	The right channel line out driver is enabled	0
		0	The right channel line out driver is in power down (default)	
5	ENHPL	1	The left channel headphones driver is enabled	0
		0	The left channel headphones driver is in power down (default)	
4	ENHPR	1	The right channel headphones driver is enabled	0
		0	The right channel headphones driver is in power down (default)	
3	ENHPVCM	1	The headphones reference voltage generator is enabled	0
		0	The headphones reference voltage generator is in power down (def)	
2	1ENEAR	1	The 32Ω earphone amplifier is enabled	0
		0	The 32Ω earphone amplifier is in power down (default)	
	2ENLS	1	The 8Ω loudspeaker amplifier is enabled	0
		0	The 8Ω loudspeaker amplifier is in power down (default)	
1	ENMIXL	1	The left channel analog output mixer is enabled	0
		0	The left channel analog output mixer is in power down (default)	
0	ENMIXR	1	The right channel analog output mixer is enabled	0
		0	The right channel analog output mixer is in power down (default)	

5.3 Gains

CR# (hex)	Description	D7	D6	D5	D4	D3	D2	D1	D0	Def.
CR3 (03h)	Mic gain left	MICLA(2:0)			MICLG(4:0)					0000 0000
CR4 (04h)	Mic gain right	MICRA(2:0)			MICRG(4:0)					0000 0000
CR5 (05h)	Line in gain left	X	X	X	LINLG(4:0)					0000 1001
CR6 (06h)	Line in gain right	X	X	X	LINRG(4:0)					0000 1001
CR7 (07h)	LO gain & LS gain	X	LOG(2:0)			LSG(3:0)				0000 0011
CR8 (08h)	HPL gain	X	X	X	HPLG(4:0)					0000 0011
CR9 (09h)	HPR gain	X	X	X	HPRG(4:0)					0000 0011
CR10 (0Ah)	DAC digital gain left	X	X	DACLG(5:0)					0000 0000	
CR11 (0Bh)	DAC digital gain right	X	X	DACRG(5:0)					0000 0000	
CR12 (0Ch)	ADC digital gain left	X	X	ADCLG(5:0)					0000 1000	
CR13 (0Dh)	ADC digital gain right	X	X	ADCRG(5:0)					0000 1000	

Table 6. CR3 and CR4 description

Bits	Name CR3 Name CR4	Value	CR3 and CR4 description	Def.
7-5	MICLA(2:0) MICRA(2:0)	000 001 010 ... 110 111	Left (CR3) and right (CR4) channels microphone attenuation 0.0 dB gain (default) -1.5 dB gain -3.0 dB gain ...step 1.5 dB -9.0 dB gain -12.0 dB gain	000
4-0	MICLG(4:0) MICRG(4:0)	00000 00001 00010 ... 11010	Left (CR3) and right (CR4) channels microphone gain 0.0 dB gain (default) 1.5 dB gain 3.0 dB gain ...step 1.5 dB 39.0 dB gain	00000

Table 7. CR5 and CR6 description

Bits	Name CR5 Name CR6	Value	CR5 and CR6 description	Def.
4-0	LINLG(4:0) LINRG(4:0)	00000	Left (CR5) and right (CR6) channels line in gain 18.0 dB gain	01001
		00001	16.0 dB gain	
		00010	14.0 dB gain	
	step 2.0 dB	
		01001	0.0 dB gain (default)	
	step 2.0 dB	
		10011	-20.0 dB gain	

Table 8. CR7 description

Bits	Name	Value	CR7 description	Def.
6-4	LOG(2:0)	000	Left and right channel line out drivers gain Gain to differential output Equivalent single-ended gain 18.0 dB gain (default) -24.0 dB gain (default)	000
		001	-15.0 dB gain -21.0 dB gain	
		010	-12.0 dB gain -18.0 dB gain	
	step 3 dB ...step 3 dB	
		110	00 dB gain -6.0 dB gain	
3-0	1EARG(3:0)	0000 0001 0010 0011 ... 1111	32 Ω earphone gain/ 8 Ω loudspeaker gain	0011
	2LSG(3:0)		6.0 dB gain	
			4.0 dB gain	
			2.0 dB gain	
			0.0 dB gain (default)	
...	...step 2.0 dB			
1111	-24.0 dB gain			

Table 9. CR8 and CR9 description

Bits	Name CR8 Name CR9	Value	CR8 and CR9 description	Def.
4-0	HPLG(4:0) HPRG(4:0)	00000	Left (CR8) and right (CR9) channels headphones driver gain 0.0 dB gain	00011
		00001	-2.0 dB gain	
		00010	-4.0 dB gain	
		00011	-6.0 dB gain (default)	
	step 2.0 dB	
		10100	-40.0 dB gain	

Table 10. CR10 and CR11 description

Bits	Name CR10 Name CR11	Value	CR10 and CR11 description	Def.
5-0	DACLG(5:0) DACRG(5:0)		Left (CR10) and right (CR11) channels DAC digital gain	000000
		000000	0.0 dB gain (default)	
		000001	-1.0 dB gain	
		000010	-2.0 dB gain	
		000011	-3.0 dB gain	
		000100	-4.0 dB gain	
		000101	-5.0 dB gain	
		000110	-6.0 dB gain	
		000111	-7.0 dB gain	
		001000	-8.0 dB gain	
		001001	-9.0 dB gain	
		001010	-10.0 dB gain	
		001011	-11.0 dB gain	
		001100	-12.0 dB gain	
		001101	-13.0 dB gain	
		001110	-14.0 dB gain	
		001111	-15.0 dB gain	
		010000	-16.0 dB gain	
		010001	-17.0 dB gain	
		010010	-18.0 dB gain	
		010011	-20.0 dB gain	
		010100	-22.0 dB gain	
		010101	-24.0 dB gain	
		010110	-26.0 dB gain	
		010111	-28.0 dB gain	
		011000	-30.0 dB gain	
		011001	-32.0 dB gain	
		011010	-34.0 dB gain	
		011011	-36.0 dB gain	
		011100	-38.0 dB gain	
		011101	-41.0 dB gain	
		011110	-44.0 dB gain	
011111	-47.0 dB gain			
100000	-50.0 dB gain			
100001	-53.0 dB gain			
100010	-56.0 dB gain			
100011	-59.0 dB gain			
100100	-65.0 dB gain			
100101	-∞dB gain			

Table 11. CR12 and CR13 description

Bits	Name CR12 Name CR13	Value	CR12 and CR13 description	Def.
5-0	ADCLG(5:0) ACDRG(5:0)		Left (CR12) and right (CR13) channels ADC digital gain	001000
		000000	8.0 dB gain	
		000001	7.0 dB gain	
		000010	6.0 dB gain	
		000011	5.0 dB gain	
		000100	4.0 dB gain	
		000101	3.0 dB gain	
		000110	2.0 dB gain	
		000111	1.0 dB gain	
		001000	0.0 dB gain (default)	
		001001	-1.0 dB gain	
		001010	-2.0 dB gain	
		001011	-3.0 dB gain	
		001100	-4.0 dB gain	
		001101	-5.0 dB gain	
		001110	-6.0 dB gain	
		001111	-7.0 dB gain	
		010000	-8.0 dB gain	
		010001	-9.0 dB gain	
		010010	-10.0 dB gain	
		010011	-11.0 dB gain	
		010100	-12.0 dB gain	
		010101	-14.0 dB gain	
		010110	-16.0 dB gain	
		010111	-18.0 dB gain	
		011000	-20.0 dB gain	
		011001	-22.0 dB gain	
		011010	-24.0 dB gain	
		011011	-26.0 dB gain	
		011100	-28.0 dB gain	
		011101	-30.0 dB gain	
		011110	-33.0 dB gain	
011111	-36.0 dB gain			
100000	-39.0 dB gain			
100001	-42.0 dB gain			
100010	-45.0 dB gain			
100011	-48.0 dB gain			
100100	-51.0 dB gain			
100101	-57.0 dB gain			
100110	-∞dB gain			

5.4 DSP control

CR# (hex)	Description	D7	D6	D5	D4	D3	D2	D1	D0	Def.
CR14 (0Eh)	Bass/treble/de-emphasis	DYNC	TREBLE(2:0)			BASS(3:0)				0000 0000
CR15 (0Fh)	DA to AD mixing gain	X	X	X	DA2ADG(4:0)				0000 0000	
CR16 (10h)	AD to DA mix/sidetone gain	X	X	AD2DAG(5:0)				0000 0000		

Table 12. CR14 description

Bits	Name	Value	CR14 description	Def.
7	DYNC	1 0	Audio dynamic compression in D/A path is enabled Audio dynamic compression in D/A path is disabled	0
6-4	TREBLE(2:0)	011 010 001 000 111 110 101 100	Treble control in D/A path +6.0 dB treble gain +4.0 dB treble gain +2.0 dB treble gain 0.0 dB treble gain -2.0 dB treble gain -4.0 dB treble gain -6.0 dB treble gain De-emphasis filter enabled	000
3-0	BASS(3:0)	0101 0100 0011 0010 0001 0000 1111 1110 1101 1100 1011	Bass control in D/A path +12.5 dB bass gain +10.0 dB bass gain +7.5 dB bass gain +5.0 dB bass gain +2.5 dB bass gain 0.0 dB bass gain -2.5 dB bass gain -5.0 dB bass gain -7.5 dB bass gain -10.0 dB bass gain -12.5 dB bass gain	0000

Table 13. CR15 description

Bits	Name	Value	CR15 description	Def.
4-0	DA2ADG(4:0)*	00000	DA to AD mixing (Audio filter in D/A and A/D path selected)	00000
			DA to AD mixing disabled (default)	
		00001	+2.0 dB gain	
		00010	0.0 dB gain	
		00011	-2.0 dB gain	
		00100	-4.0 dB gain	
		00101	-6.0 dB gain	
		00110	-8.0 dB gain	
		00111	-10.0 dB gain	
		01000	-12.0 dB gain	
		01001	-14.0 dB gain	
		01010	-16.0 dB gain	
		01011	-18.0 dB gain	
		01100	-20.0 dB gain	
		01101	-22.0 dB gain	
		01110	-24.0 dB gain	
		01111	-26.0 dB gain	
		10000	-28.0 dB gain	
		10001	-30.0 dB gain	
		10010	-32.0 dB gain	
10011	-34.0 dB gain			
10100	-36.0 dB gain			
10101	-38.0 dB gain			
10110	-40.0 dB gain			

* When Voice filter in D/A or A/D path is selected this function is disabled

Note:

D/A to A/D mixing is performed at AD data rate, so if A/D and D/A rates are different then asynchronous sampling artifacts may occur.

Table 14. CR16 description

Bits	Name	Value	CR16 description	Def.
5-0	AD2DAG(5:0)	000000	AD to DA mixing (sidetone) AD to DA mixing disabled (default)	000000
		000001	-1.0 dB gain	
		000010	-2.0 dB gain	
		000011	-3.0 dB gain	
		000100	-4.0 dB gain	
		000101	-5.0 dB gain	
		000110	-6.0 dB gain	
		000111	-7.0 dB gain	
		001000	-8.0 dB gain	
		001001	-9.0 dB gain	
		001010	-10.0 dB gain	
		001011	-11.0 dB gain	
		001100	-12.0 dB gain	
		001101	-13.0 dB gain	
		001110	-14.0 dB gain	
		001111	-15.0 dB gain	
		010000	-16.0 dB gain	
		010001	-17.0 dB gain	
		010010	-18.0 dB gain	
		010011	-19.0 dB gain	
		010100	-20.0 dB gain	
		010101	-21.0 dB gain	
		010110	-22.0 dB gain	
		010111	-23.0 dB gain	
		011000	-24.0 dB gain	
		011001	-25.0 dB gain	
		011010	-26.0 dB gain	
		011011	-27.0 dB gain	
		011100	-28.0 dB gain	
		011101	-29.0 dB gain	
		011110	-30.0 dB gain	
		011111	-31.0 dB gain	
		100000	-32.0 dB gain	
100001	-33.0 dB gain			
100010	-34.0 dB gain			
100011	-35.0 dB gain			
100100	-36.0 dB gain			
100101	-37.0 dB gain			
100110	-38.0 dB gain			
100111	-39.0 dB gain			
101000	-40.0 dB gain			
101001	-41.0 dB gain			
101010	-42.0 dB gain			

5.5 Analog functions

CR# (hex)	Description	D7	D6	D5	D4	D3	D2	D1	D0	Def.
CR17 (11h)	Mixer switches & Mic Bias	MBIAS	MBIASPD	ADMIC	ADLIN	MIXMIC	MIXLIN	MIXDAC	MICLO	0000 0000
CR18 (12h)	Input switches	X	IN2VCM	LINMUTE	LINSEL(1:0)		MICMUTE	MICSEL(1:0)		0010 0100
CR19 (13h)	Drivers control	VCML(1:0)		X	MUTELO	MUTEHP	LSLIM	LSSEL(1:0)		0101 1000

Table 15. CR17 description

Bits	Name	Value	CR17 description	Def.
7	MBIAS	1	Microphone Bias enabled (2.1V typ at MBIAS pin)	0
		0	Microphone Bias disabled	
6	MBIASPD	1	MBIAS pin is pulled down when microphone bias is disabled	0
		0	MBIAS pin is in high impedance state when microphone Bias is disabled	
5	ADMIC	1	Microphone preamplifiers are connected to AD path	0
		0	Microphone preamplifiers are not connected to AD path	
4	ADLIN	1	Line in preamplifiers are connected to AD path	0
		0	Line in preamplifiers are not connected to AD path	
3	MIXMIC	1	Microphone preamplifiers are connected to mixers	0
		0	Microphone preamplifiers are not connected to mixers	
2	MIXLIN	1	Line in preamplifiers are connected to mixers	0
		0	Line in preamplifiers are not connected to mixers	
1	MIXDAC	1	Stereo DAC path is connected to mixers	0
		0	Stereo DAC path is not connected to mixers	
0	MICLO	1	Microphone preamplifiers are connected to line out drivers	0
		0	Mixers are connected to line out drivers	

Table 16. CR18 description

Bits	Name	Value	CR18 description	Def.
6	IN2VCM	1	Unused analog input pins are biased to common mode voltage	0
		0	Unused analog input pins are in high impedance state	
5	LINMUTE	1	Line in preamplifiers are muted	1
		0	Line in preamplifiers are not muted	
4-3	LINSEL(1:0)	00	Input pins connected to line in preamplifiers (if LINMUTE=0) LINEIN (LINEINL, LINEINR)	00
		01	AUX1 (AUX1L, AUX1R)	
		10	AUX2 (AUX2LP-AUX2LN, AUX2RP-AUX2RN)	
		11	AUX3 (AUX3L, AUX3R)	

Table 16. CR18 description

Bits	Name	Value	CR18 description	Def.
2	MICMUTE	1 0	Microphone preamplifiers are muted Microphone preamplifiers are not muted	1
1-0	MICSEL(1:0)	00 01 10 11	Input pins connected to microphone preamplifiers (if MICMUTE=0) MIC (MICLP-MICLN, MICRP-MICRN) AUX1 (AUX1L, AUX1R) AUX2 (AUX2LP-AUX2LN, AUX2RP-AUX2RN) AUX3 (AUX3L, AUX3R)	00

Table 17. CR19 description

Bits	Name	Value	CR19 Description	Def.
7-6	VCML(1:0)	00 01 10 11	Common mode voltage level for line out and headphones drivers 1.20 V 1.35 V (default) 1.50 V 1.65 V	01
4	MUTELO	1 0	Line out drivers are muted Line out drivers are not muted	1
3	MUTEHP	1 0	Headphones drivers (HP) are muted Headphones drivers (HP) are not muted	1
2	1EARLIM 2LSLIM	1 0	EAR/LS driver gain is limited when V_{CCLS} is above 4.2V typ EAR/LS driver (LS) gain is not limited	0
1-0	1EARSEL(1:0) 2LSSEL(1:0)	00 01 10 11	Mute Loudspeaker driver (LS) is muted Right Right channel mixer only connected to loudspeaker driver Left Left channel mixer only connected to loudspeaker driver Mono (Left + Right)/2 channel mixers connected to loudspeaker driver	00

5.6 Digital audio interfaces master mode and clock generators

CR# (hex)	Description	D7	D6	D5	D4	D3	D2	D1	D0	Def.
CR20 (14h)	DAOCK frequency LSB	DAOCKF(7:0)								0000 0000
CR21 (15h)	DAOCK frequency MSB	DAOCKF(15:8)								0000 0000
CR22 (16h)	DA clock generator control	X	X	DAMAST	DA MASTGEN	END OCK	DAO CK512	DAPCMF(1:0)		0000 0000
CR23 (17h)	ADOCK frequency LSB	ADOCKF(7:0)								0000 0000
CR24 (18h)	ADOCK frequency MSB	ADOCKF(15:8)								0000 0000
CR25 (19h)	AD clock generator control	X	X	ADMAST	AD MASTGEN	ENA DOCK	ADO CK512	ADPCMF(1:0)		0000 0000

Table 18. CR21-20 and CR24-23 description

Bits	Name CR21-20 Name CR24-23	Value	CR21-20 and CR24-23 Description	Def.
15-0	DAOCKF(15:0) ADOCKF(15:0)	K	<p>The following formulas can be used to obtain the value of K for the desired FS or OCK respectively in the clock generator</p> $K(FS) = \text{round}\left(2^{25} \frac{FS}{AMCK \cdot MCKCOEFF}\right)$ $K(OCK) = \text{round}\left(2^{25} \frac{OCK}{AMCK \cdot MCKCOEFF \cdot OSR}\right)$ <p>FS: Data rate (DA_SYNC or AD_SYNC frequency in master mode) OCK: Oversampled clock frequency (DA_OCK or AD_OCK) AMCK: Input master clock frequency MCKCOEFF: See CR30 for definition OSR: See bit 2 in CR22 and CR25</p>	0000h

Note: CR21-20 and CR24-23 are meaningful in master mode only.

Table 19. CR22 and CR25 description

Bits	Name CR22 (Name CR25)	Value	CR22 and CR25 description	Def.
5	DAMAST (ADMAST)	1 0	DA (AD) Audio interface is in master mode (low impedance output) DA (AD) Audio interface is in slave mode (high impedance input)	0
4	DAMASTGEN (ADMASTGEN)	1 0	DA (AD) Master generator is enabled DA (AD) Master generator is disabled	0
3	ENDAOCK (ENADOCK)	1 0	DA_OCK (AD_OCK) output clock is enabled DA_OCK (AD_OCK) output clock is disabled	0

Table 19. CR22 and CR25 description

Bits	Name CR22 (Name CR25)	Value	CR22 and CR25 description	Def.
2	DAOCK512 (ADOCK512)	1 0	Definition of DA_OSR (AD_OSR) DA_OCK/DA_SYNC (AD_OCK/AD_SYNC) ratio in master mode is 512 da_ock/da_sync (ad_ock/ad_sync) ratio in master mode is 256	0
1-0	DAPCMF(1:0) (ADPCMF(1:0))	00 00 01 10 11 11	DA_CK/DA_SYNC (AD_CK/AD_SYNC) Ratio in PCM master mode - 16 when CR26 DAWL=000 (CR27 ADWL=000) - 32 when CR26 DAWL≠000 (CR27 ADWL≠000) - 64 - 128 - 256 when CR22 DAOCK512=0 (CR25 ADOCK512=0) - 512 when CR22 DAOCK512=1 (CR25 ADOCK512=1)	00

5.7 Digital audio interfaces

CR# (hex)	Description	D7	D6	D5	D4	D3	D2	D1	D0	Def.
CR26 (1Ah)	DAC data IF control	X	DAFORM(2:0)			DASPIM	DAWL(2:0)			0000 0000
CR27 (1Bh)	ADC data IF control	ADRTOL	ADFORM2:0)			ADSPIM	ADWL(2:0)			0000 0000
CR28 (1Ch)	DAC&ADC data IF control	AMCKINV	DACKP	DASYNCP	DAMONO	ADCKP	AD SYNCP	ADMONO	ADHIZ	0000 0000

Table 20. CR26 description

Bits	Name	Value	CR26 Description	Def.
6-4	DAFORM(2:0)	000	DA audio interface format selection Delayed format (I ² S compatible)	000
		001	Left aligned format	
		010	Right aligned format	
		011	DSP format	
		100	SPI format	
		111	PCM format (uses left channel)	
3	DASPIM	1	DA interface in SPI mode receives one word for both channels	0
		0	DA interface in SPI mode receives two words (alternated, left channel first)	
2-0	DAWL(2:0)	000	DA interface word length 16 bit	000
		001	18 bit	
		010	20 bit	
		011	24 bit	
		100	32 bit	

Table 21. CR27 description

Bits	Name	Value	CR27 description	Def.
7	ADRTOL	1	AD right channel sent to PCM I/F (must set ENADCR=0 in CR1)	0
		0	Normal operation	
6-4	ADFORM(2:0)	000	AD audio interface format selection Delayed format (I ² S compatible)	000
		001	Left aligned format	
		010	Right aligned format	
		011	DSP format	
		100	SPI format	
		111	PCM format (sends out left channel)	

Table 21. CR27 description (continued)

Bits	Name	Value	CR27 description	Def.
3	ADSPIM	1	AD interface in SPI mode sends one channel (left)	0
		0	AD interface in SPI mode sends two channels (alternated, left first)	
2-0	ADWL(2:0)	000	AD interface word length 16 bit	000
		001	18 bit	
		010	20 bit	
		011	24 bit	
		100	32 bit	

Table 22. CR28 description

Bits	Name	Value	CR28 description	Def.
7	AMCKINV	1	AMCK is inverted	0
		0	AMCK is not inverted	
6	DACKP	1	DA Bit clock pin (DA_CK) polarity is inverted	0
		0	DA Bit clock pin (DA_CK) polarity is not inverted	
5	DASYNCP	1	DSP and PCM formats in DA interface Non delayed format	0
			0	
		1		
			0	
4	DAMONO	1		Mono mode: (L+R)/2 from Audio Interface is used on both DAC channels
		0	Stereo mode	
3	ADCKP	1	AD Bit clock pin (AD_CK) polarity is inverted	0
		0	AD Bit clock pin (AD_CK) polarity is not inverted	
2	ADSYNCP	1	DSP and PCM formats in AD interface Non delayed format	0
			0	
		1		
			0	
1	ADMONO	1		Mono mode: (L+R)/2 from ADC is sent to both channels in the Audio interface
		0	Stereo mode	
0	ADHIZ	1	AD data pin (AD_DATA) is in high impedance state when no data is available	0
		0	AD data pin (AD_DATA) is forced to 0 when no data is available	

5.8 Digital filters, software reset and master clock control

CR# (hex)	Description	D7	D6	D5	D4	D3	D2	D1	D0	Def.
CR29 (1Dh)	Digital filters control	X	DAVOICE	DA96K	RXNH	ADVOICE	AD96K	ADNH	TXNH	0000 0000
CR30 (1Eh)	Soft reset & AMCK range	SWRES	X	X	X	AMCKSIN	CKRANGE(2:0)			0000 0000

Table 23. CR29 description

Bits	Name	Value	CR29 description	Def.
6	DAVOICE	1	DA path voice RX filter is enabled (single channel, left used)	0
		0	DA path voice filters are enabled	
5	DA96K	1	DA path data rate is in the range 88 kHz to 96 kHz	0
		0	DA path data rate is in the range 8 kHz to 48 kHz	
4	RXNH	1	DA path high pass voice RX filter is disabled	0
		0	DA path high pass voice RX filter is enabled (300Hz @ 8kHz rate)	
3	ADVOICE	1	AD path voice TX filter is enabled (single channel, left used)	0
		0	AD path audio filters are enabled	
2	AD96K	1	AD path data rate is in the range 88 kHz to 96 kHz	0
		0	AD path data rate is in the range 8 kHz to 48 kHz	
1	ADNH	1	AD path audio DC filter is disabled	0
		0	AD path audio DC filter is enabled	
0	TXNH	1	AD path high pass voice TX filter is disabled	0
		0	AD path high pass voice TX filter is enabled (300Hz @ 8kHz rate)	

Table 24. CR30 description

Bits	Name	Value	CR30 description	Def.	
7	SWRES	1	Software reset: All registers content is reset to the default value	0	
		0	Control Register content is left unchanged		
3	AMCKSIN	1	Signal at AMCK pin is a sinusoid	0	
		0	Signal at AMCK pin is a square wave		
2-0	CKRANGE(2:0)	000	AMCK range	000	
			4.0 MHz to 6.0 MHz		MCKCOEFF
		001	6.0 MHz to 8.0 MHz		8.0
		010	8.0 MHz to 12.0 MHz		6.0
		011	12.0 MHz to 16.0 MHz		4.0
		100	16.0 MHz to 24.0 MHz		3.0
101	24.0 MHz to 32.0 MHz	2.0			
			1.5		

5.9 Interrupt control and control interface SPI out mode

CR# (hex)	Description	D7	D6	D5	D4	D3	D2	D1	D0	Def.
CR31 (1Fh)	Interrupt mask	VLSHEN	PUSH BEN	HSDETEN	VLSHMSK	PUSH BMSK	HSDET MSK	OVFMSK	PORMSK	0000 0000
CR32 (20h)	Interrupt status	VLSH	PUSHB	HSDET	VLSHEV	PUSHBEV	HSDETEVEV	OVFEV	POREV	0000 0000
CR33 (21h)	Misc. control	x	X	SPIOHIZ	SPIOSEL(1:0)		IRQCMOS	OVFDA	OVFAD	0000 0000

Table 25. CR31 description

Bits	Name	Value	CR31description	Def.
7	VLSHEN	1 0	VLSH status can be seen at IRQ output VLSH status is masked	0
6	PUSHBEN	1 0	PUSHB status can be seen at IRQ output PUSHB status is masked	0
5	HSDETEN	1 0	HSDET status can be seen at IRQ output HSDET status is masked	0
4	VLSHMSK	1 0	VLSH event can be seen at IRQ output VLSH event is masked	0
3	PUSHBMSK	1 0	PUSHB event can be seen at IRQ output PUSHB event is masked	0
2	HSDETMSK	1 0	HSDET event can be seen at IRQ output HSDET event is masked	0
1	OVFMSK	1 0	OVF event can be seen at IRQ output OVF event is masked	0
0	PORMSK	1 0	POR event can be seen at IRQ output POR event is masked	0

Note: Value at IRQ pin is:

$$\text{IRQ} = \begin{cases} (1 \text{ or } Z) & \text{when } (\text{CR31} \ \& \ \text{CR32}) = 00 \text{ hex} \\ 0 & \text{when } (\text{CR31} \ \& \ \text{CR32}) \neq 00 \text{ hex} \end{cases}$$

Table 26. CR32 description

Bits	Name	Read only	CR32 description	Def.
7	VLSH*	1 0	V _{CCLS} is above 4.2 V V _{CCLS} is below 4.0 V	0
6	PUSHB*	1 0	Headset Button is pressed Headset Button is released	0
5	HSDET*	1 0	Headset Connector is inserted Headset Connector is not inserted	0

Table 26. CR32 description (continued)

Bits	Name	Read only	CR32 description	Def.
4	VLSHEV	1 0	VLSH bit has changed VLSH bit has not changed	0
3	PUSHBEV	1 0	Headset Button Status has changed Headset Button Status has not changed	0
2	HSDETEV	1 0	Headset Connector Status has changed Headset Connector Status has not changed	0
1	OVFEV	1 0	An Audio Data overflow has occurred in DSP No Audio Data overflow has occurred in DSP	0
0	POREV	1 0	Device was reset by power-on-reset Device was not reset by power-on-reset	0

Note: content of bits 4 to 0 in CR32 is cleared after reading, while it is left unchanged if accessed for writing.

*Bits 7 to 5 represent the status when the Control register is read, not when the event occurred.

Table 27. CR33 description

Bits	Name	Val.	CR33 description	Def.
5	SPIOHIZ	1 0	SPI control interface out pin is set to high impedance state when inactive SPI control interface out pin is set to zero when inactive	0
4-3	SPIOSEL(1:0)	00 01 10 11	Out pin selection for SPI control interface No output. Control registers cannot be read in SPI mode SPI output sent to IRQ pin SPI output sent to DA_OCK pin SPI output sent to AD_OCK pin	00
2	IRQCMOS	1 0	IRQ interrupt request pin is set to CMOS (active low) IRQ interrupt request pin is set to pull down	0
1	OVFDA	1 0	An overflow (saturation) occurred in DA path No overflow occurred in DA channel	0
0	OVFAD	1 0	An overflow (saturation) occurred in AD path No overflow occurred in AD channel	0

Note: content of bits 1 to 0 in CR33 is cleared after reading, while it is left unchanged if accessed for writing.

5.10 AGC

CR# (hex)	Description	D7	D6	D5	D4	D3	D2	D1	D0	Def.
CR34 (22h)	AGC attack/decay coeff.	AGCATT(3:0)				AGCDEC(3:0)				0000 0000
CR35 (23h)	AGC control	x	ENAG CLIN	ENAG CMIC	AGC RANGE	AGCLEV(3:0)				0000 0000

Table 28. CR 34 description

Bits	Name	Value	CR 34 description		Def.			
7-4	AGCATT(3:0)		AGC attack time constant; FS=AD data rate		0000			
		0000	Audio filter in AD path 4096 / FS	Voice filter in AD path 8192 / FS				
		0001	2048 / FS	4096 / FS				
		0010	1365 / FS	2731 / FS				
		0011	1024 / FS	2048 / FS				
		0100	683 / FS	1365 / FS				
		0101	512 / FS	1024 / FS				
		0110	341 / FS	683 / FS				
		0111	256 / FS	512 / FS				
		1000	171 / FS	341 / FS				
		1001	128 / FS	256 / FS				
		1010	85 / FS	171 / FS				
		1011	64 / FS	128 / FS				
		1100	43 / FS	85 / FS				
		1101	32 / FS	64 / FS				
		3-0	AGCDEC(3:0)			AGC decay time constant; FS=AD data rate		0000
				0000		Audio filter in AD path 65536 / FS	Voice filter in AD path 131072 / FS	
0001	32768 / FS			65536 / FS				
0010	21845 / FS			43691 / FS				
0011	16384 / FS			32768 / FS				
0100	10923 / FS			21845 / FS				
0101	8192 / FS			16384 / FS				
0110	5461 / FS			10923 / FS				
0111	4096 / FS			8192 / FS				
1000	2731 / FS			5461 / FS				
1001	2048 / FS			4096 / FS				
1010	1365 / FS			2731 / FS				
1011	1024 / FS			2048 / FS				
1100	683 / FS			1365 / FS				
1101	512 / FS			1024 / FS				
1110	341 / FS			683 / FS				
1111	256 / FS			512 / FS				

Table 29. CR 35 description

Bits	Name	Value	CR35 description	Def.
6	ENAGCLIN	1 0	AGC control on AD path acts on Line In Gain AGC control on AD path does not act on Line In Gain	0
5	ENAGCMIC	1 0	AGC control on AD path acts on Mic Gain AGC control on AD path does not act on Mic Gain	0
4	AGCRANGE	1 0	AGC action range is -21.0 dB to +21.0 dB AGC action range is -10.5 dB to +10.5 dB	0
3-0	AGCLEV(3:0)	0000 0001 0010 0011 0100 0101 0110 0111 1000 1001	AGC requested output level -30.0 dB gain -30.0 dB gain -27.0 dB gain -24.0 dB gain -21.0 dB gain -18.0 dB gain -15.0 dB gain -12.0 dB gain -9.0 dB gain -6.0 dB gain	0000

6 Control interface and master clock

Unless specified, the following description applies to both entities.

6.1 Control interface I²C mode

Figure 5. Control interface I²C format

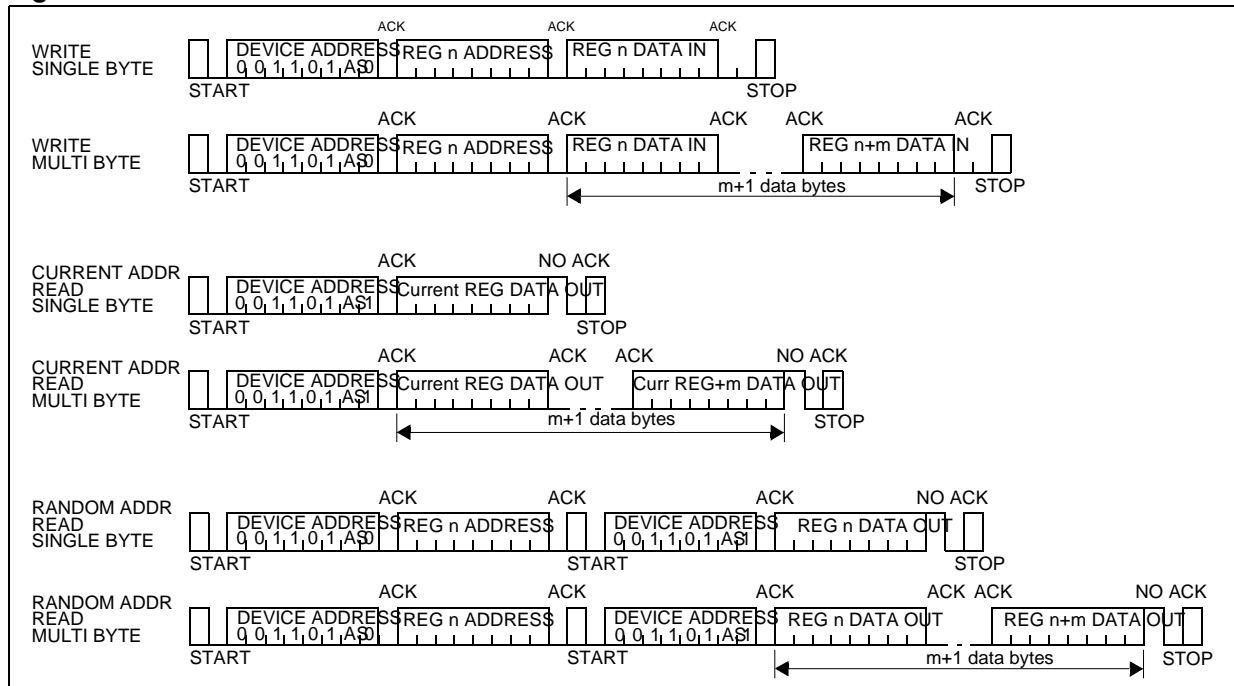

Note: CMOD pin tied to GND

Figure 6. Control interface: I²C format timing

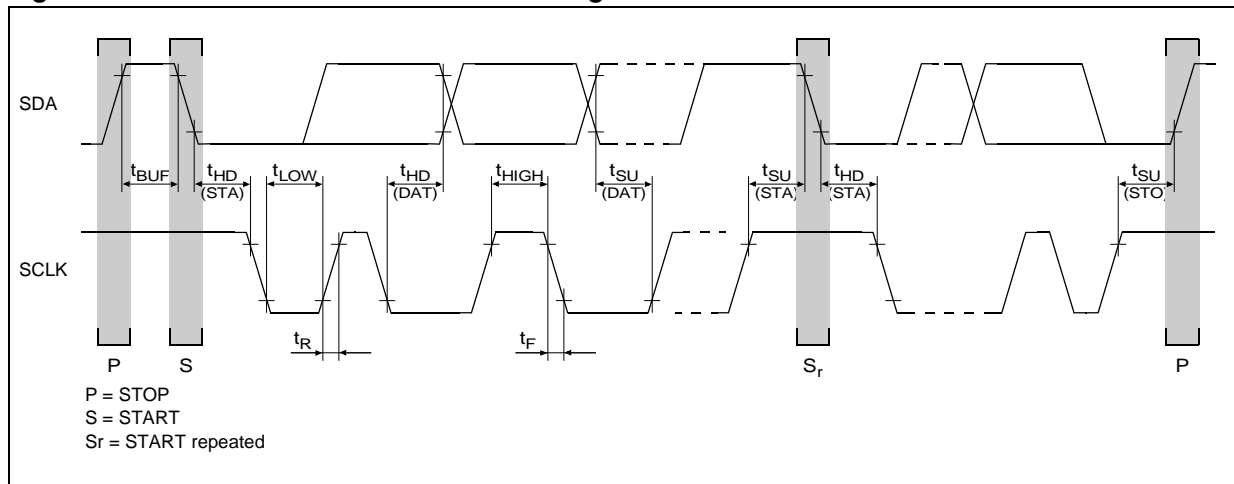
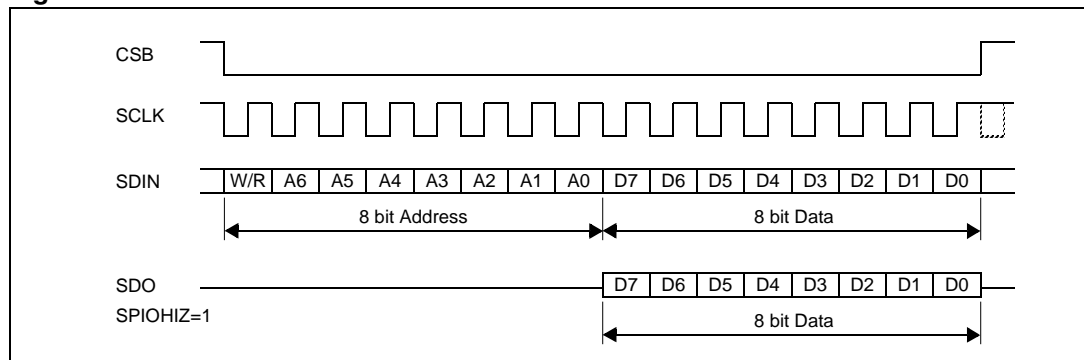

Table 30. Control interface timing with I²C format

Symbol	Parameter	Test conditions	Min.	Typ.	Max.	Unit
f _{SCL}	Clock frequency				400	kHz
t _{HIGH}	Clock pulse width high		600			ns
t _{LOW}	Clock pulse width low		1300			ns
t _R	SDA and SCLK rise time				1000	ns
t _F	SDA and SCLK fall time				300	ns
t _{HD:STA}	Start condition hold time		600			ns
t _{SU:STA}	Start condition setup time		600			ns
t _{HD:DAT}	Data input hold time		0			ns
t _{SU:DAT}	Data input setup time		250			ns
t _{SU:STO}	Stop condition setup time		600			ns
t _{BUF}	Bus free time		1300			ns

6.2 Control interface SPI mode

Figure 7. Control interface SPI format^(a)



a. CMOD pin tied to V_{CCIO}; SDO pin position selected with bits SPIOSEL in CR33.

Figure 8. Control interface: SPI format timing

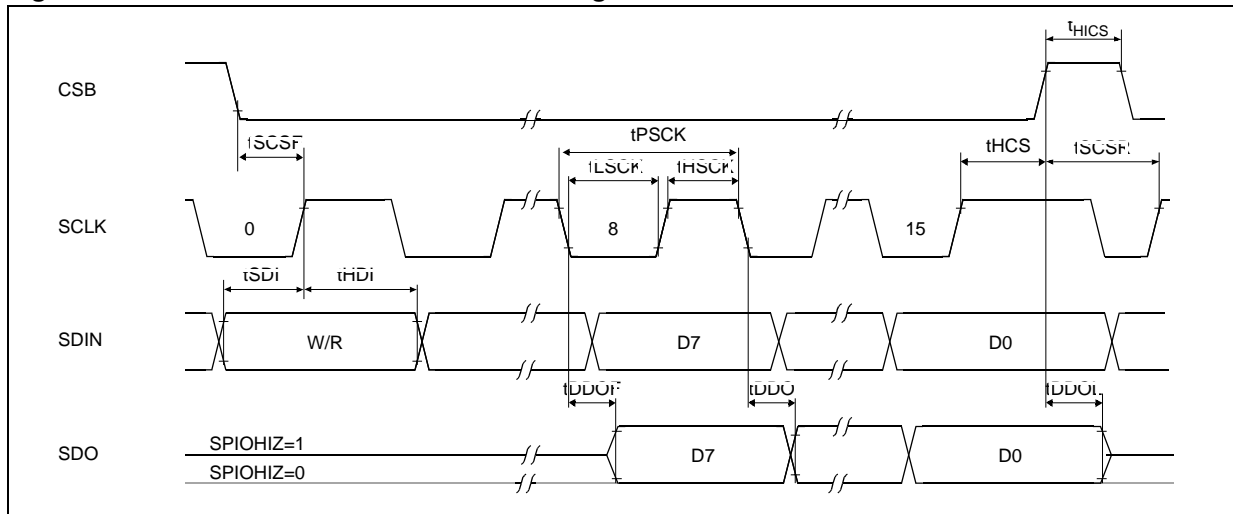

Table 31. Control interface signal timing with SPI format

Symbol	Parameter	Test conditions	Min.	Typ.	Max.	Unit
t _{HICS}	CSB pulse width high		80			ns
t _{SCSR}	Setup time CSB rising edge to SCLK rising edge		20			ns
t _{SCSF}	Setup time CSB falling edge to SCLK rising edge		20			ns
t _{HCS}	Hold time CSB rising edge from SCLK rising edge		20			ns
t _{SDI}	Setup time SDIN to SCLK rising edge		20			ns
t _{HDI}	Hold time SDIN from SCLK rising edge		20			ns
t _{DDOF}	SDO first Delay time from SCLK falling edge				30	ns
t _{DDO}	SDO Delay time from SCLK falling edge				20	ns
t _{DDOL}	SDO Delay time from CSB rising edge				30	ns
t _{PSCK}	Period of SCK		100			ns
t _{HSCK}	SCK pulse width high	Measured from V _{IH} to V _{IH}	40			ns
t _{LSCK}	SCK pulse width low	Measured from V _{IL} to V _{IL}	40			ns

6.3 Master clock timing

Table 32. AMCK timing

Symbol	Parameter	AMCK range	Min.	Typ.	Max.	Unit
t_{CKDC}	AMCK duty cycle	4 MHz-8 MHz	45		55	%
		8 MHz-32 MHz	40		60	%

7 Audio interfaces

Information included in the following section is valid for both entities.

Figure 9. Audio interfaces formats: delayed, left and right justified

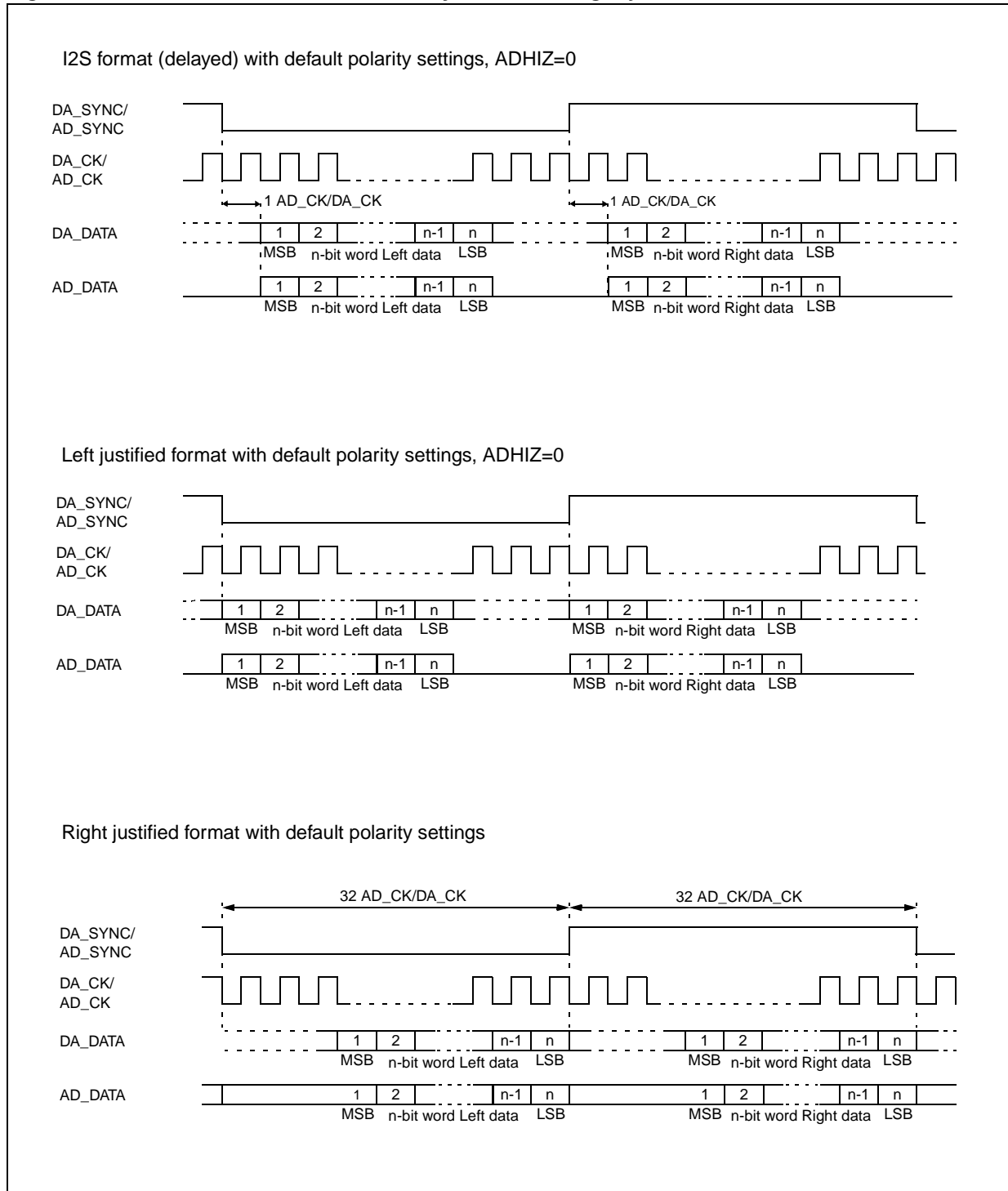

Figure 10. Audio interfaces formats: DSP, SPI and PCM

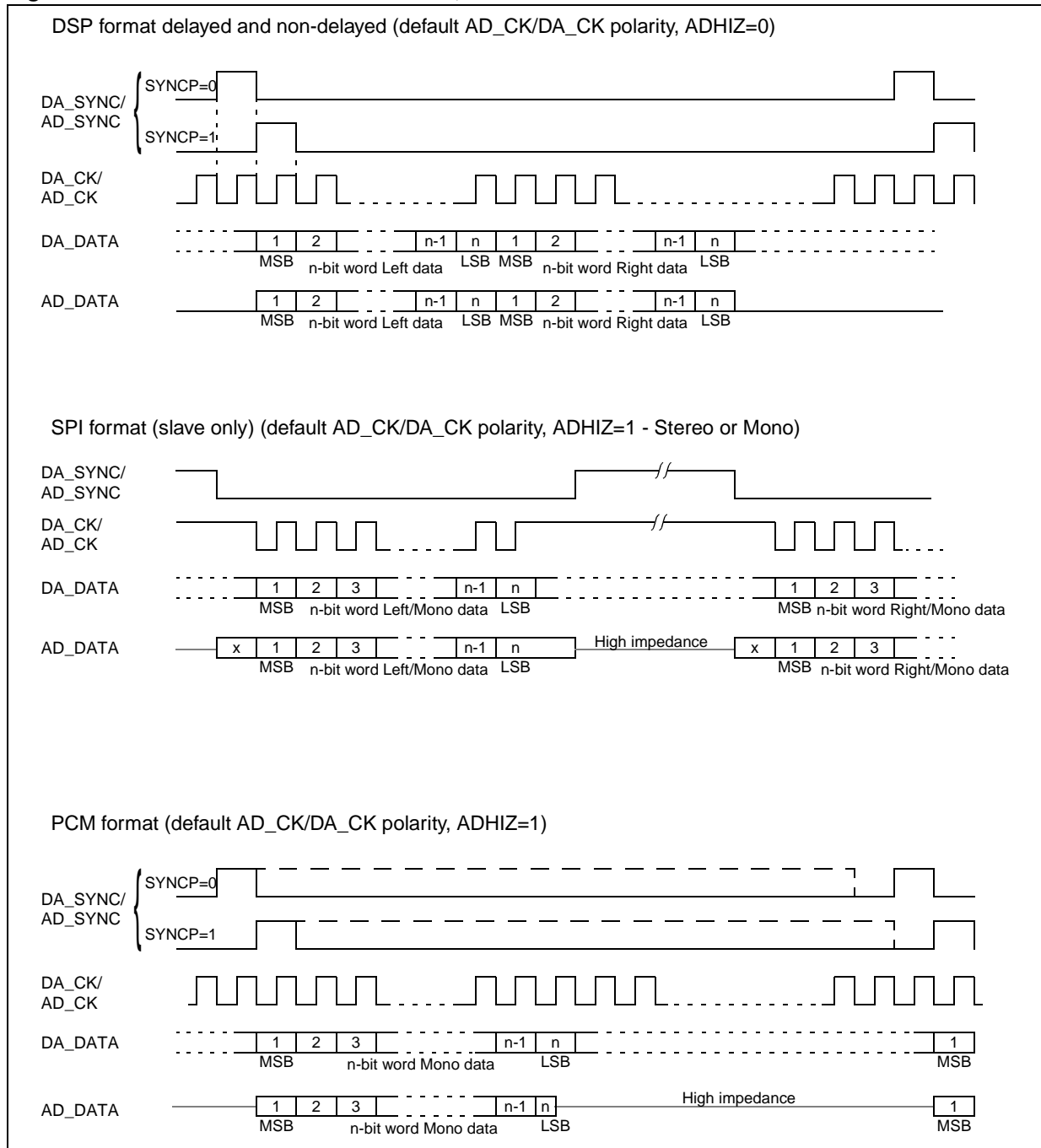

Figure 11. Audio interface timings: master mode

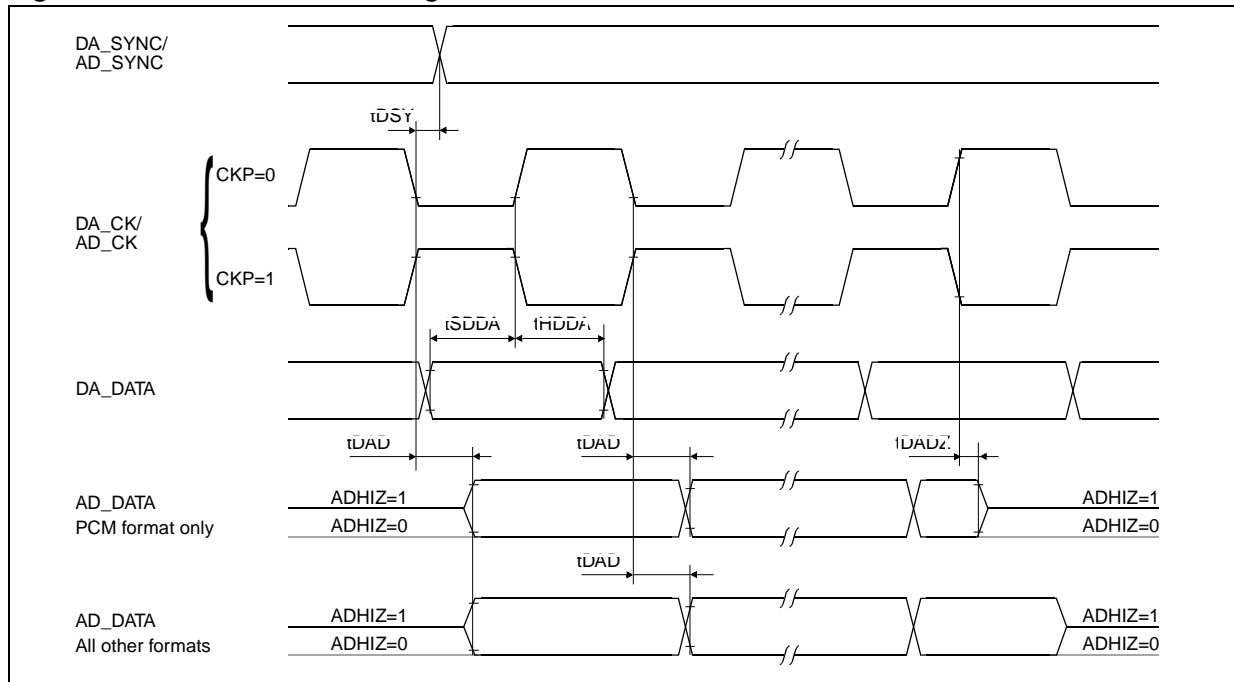

Figure 12. Audio interface timing: slave mode

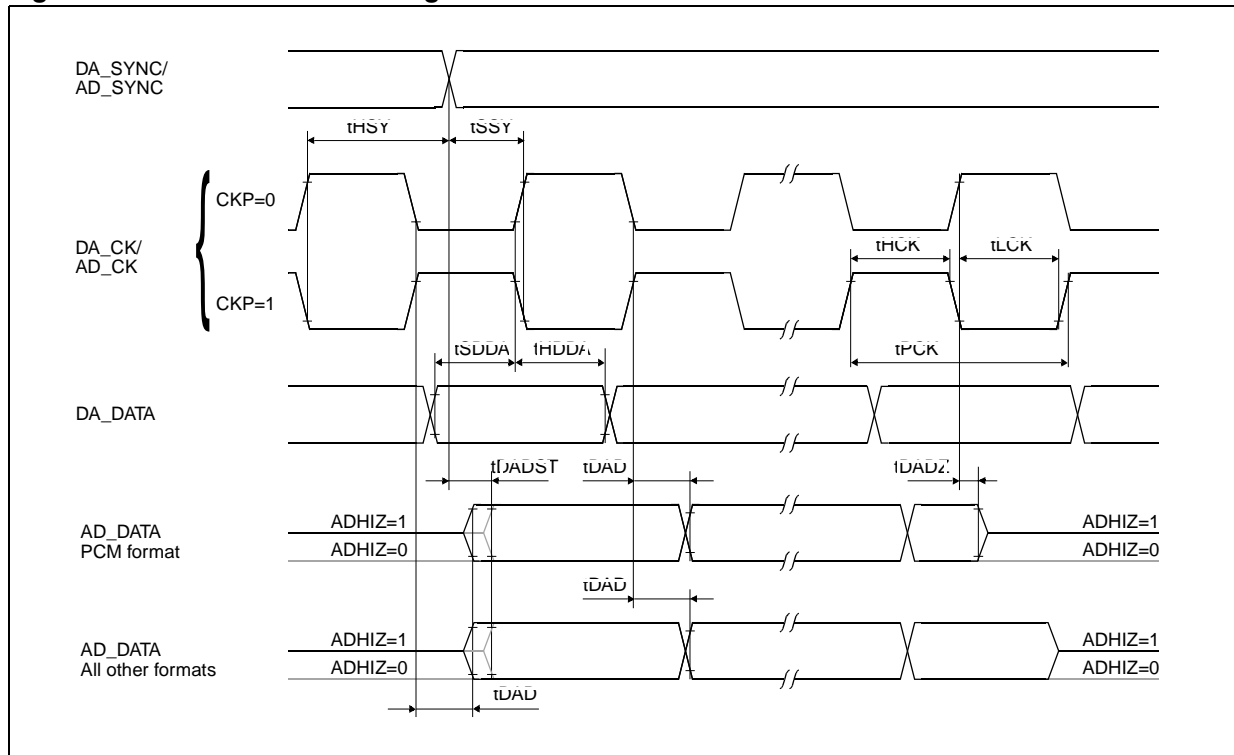

Table 33. Audio interface signal timings

Symbol	Parameter	Test conditions	Min.	Typ.	Max.	Unit
t_{DSY}	Delay of AD_SYNC/DA_SYNC edge from AD_CK/DA_CK active edge	Master Mode			10	ns
t_{SDDA}	Setup time DA_DATA to DA_CK active edge		10			ns
t_{HDDA}	Hold time DA_DATA from DA_CK active edge		10			ns
t_{DAD}	Delay of AD_DATA edge from AD_CK active edge				30	ns
t_{DADST}	Delay of the first AD_DATA edge from AD_SYNC active edge	AD_SYNC active edge comes after AD_CK active edge			30	ns
t_{DADZ}	Delay of AD_DATA high impedance from AD_SYNC inactive edge	PCM format	10		50	ns
t_{SSY}	Setup time AD_SYNC/DA_SYNC to AD_CK/DA_CK active edge	Slave Mode	20			ns
t_{HSY}	Hold time AD_SYNC/DA_SYNC from AD_CK/DA_CK active edge	Slave Mode	20			ns
t_{PCK}	Period of AD_CK/DA_CK	Slave Mode	100			ns
t_{HCK}	AD_CK/DA_CK pulse width high	Measured from V_{IH} to V_{IH}	40			ns
t_{LCK}	AD_CK/DA_CK pulse width low	Measured from V_{IL} to V_{IL}	40			ns

8 Timing specifications

Information included in this section is valid for both entities.

Unless otherwise specified, $V_{CCIO} = 1.71V$ to $2.7V$, $T_{amb} = -30^{\circ}C$ to $85^{\circ}C$, max capacitive load 20 pF ; typical characteristics are specified at $V_{CCIO} = 2.4\text{ V}$, $T_{amb} = 25^{\circ}C$; all signals are referenced to GND, see Note below figure for timing definitions.

Figure 13. A.C. testing input-output waveform

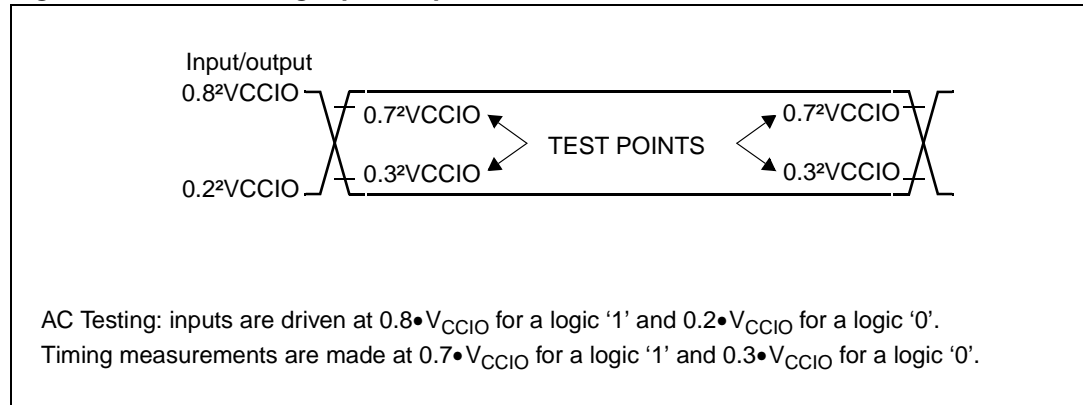

- Note:** A signal is valid if it is above V_{IH} or below V_{IL} and invalid if it is between V_{IL} and V_{IH} . For the purpose of this specification the following conditions apply (see [Figure 13](#) above):
- All input signal are defined as: $V_{IL} = 0.2 \cdot V_{CCIO}$, $V_{IH} = 0.8 \cdot V_{CCIO}$, $t_R < 10ns$, $t_F < 10ns$.
 - Delay times are measured from the inputs signal valid to the output signal valid.
 - Setup times are measured from the data input valid to the clock input invalid.
 - Hold times are measured from the clock signal valid to the data input invalid.

Note: All timing specifications subject to change.

9 Operative ranges

9.1 Absolute maximum ratings

Table 34. Absolute maximum ratings

Parameter	Value	Unit	
V_{CC} or V_{CCIO} to GND	-0.5 to 3.6	V	
V_{CCA} or V_{CCP} to GND	-0.5 to 5	V	
V_{CCLS} to GND	-0.5 to 7	V	
Voltage at analog inputs ($V_{CCA} \leq 3.3V$)	GND-0.5 to $V_{CCA}+0.5$	V	
Maximum power delivered to the load from LSP/N	500	mW	
Peak current at HPR,HPL	100	mA	
Current at V_{CCP} , V_{CCLS} , GNDP	350	mA	
Current at any digital output	50	mA	
Voltage at any digital input ($V_{CCIO} \leq 2.7V$); limited at $\pm 50mA$	GND-0.5 to $V_{CCIO}+0.5$	V	
Storage temperature range	-65 to 150	°C	
Operating temperature range ⁽¹⁾	-30 to 85	°C	
Electrostatic discharge voltage (Vesd)	Human body model ⁽²⁾	-2 to +2	kV
	Charge device model ⁽³⁾	-500 to +500	V

1. in some operating conditions the temperature can be limited to 70 °C. See loudspeaker driver description from [Section 4.10](#) for details.

2. HBM tests have been performed in compliance with JESD22-A114-B and ESD STM 5.1-2001.HBM

3. CDM tests have been performed in compliance with CDM ANSI-ESDSTM5.3.1-1999

9.2 Operative supply voltage

Table 35. Operative supply voltage

Symbol	Parameter	Condition	Min.	Max.	Unit
V_{CC}	Digital supply		1.71	2.7	V
V_{CCA}	Analog supply Note: $V_{CCA} \geq V_{CC}$	A24V=0 (bit 1 in CR0)	2.7	3.3	V
		A24V=1 (bit 1 in CR0)	2.4	2.7	V
V_{CCIO}	Digital I/O supply	D12V=0 (bit 0 in CR0)	1.71	V_{CC}	V
		D12V=1 (bit 0 in CR0)	1.2	1.8	V
V_{CCP}	Stereo power drivers supply		V_{CCA}	3.3	V
V_{CCLS}	Mono power driver supply		V_{CCA}	5.5	V
V_G	Single supply voltage range	$V_{CC}=V_{CCA}=V_{CCIO}=V_{CCP}=V_{CCLS}$ A24V=1 (bit 1 in CR0)	2.4	2.7	V

9.3 Power dissipation

Unless otherwise specified, $V_{CCP} = V_{CCLS} = V_{CCA} = 2.7V$ to $3.3V$, $V_{CCIO} = V_{CC} = 1.71V$ to $2.7V$, $T_{amb} = -30^{\circ}C$ to $85^{\circ}C$, all analog outputs not loaded; typical characteristics are specified at $V_{CCIO} = V_{CC} = 1.8V$, $V_{CCP} = V_{CCLS} = V_{CCA} = 2.7V$, $T_{amb} = 25^{\circ}C$.

Table 36. Power dissipation

Symbol	Parameter	Test conditions	Min.	Typ.	Max.	Unit
POFF	Power Down Dissipation	No Master Clock AMCK=13MHz		0.8		μW
				5.8		μW
PAD	Stereo ADC power			52.6		mW
PDA	Stereo DAC power			46.6		mW
PDAAD	Stereo ADC+DAC power			93.8		mW
PAA	Stereo Analog Path power			27.6		mW

9.4 Typical power dissipation by entity

$T_{amb} = 25^{\circ}C$; Analog Supply: $V_{CCP} = V_{CCLS} = V_{CCA} = 2.7V$;
digital supply: $V_{CCIO} = V_{CC} = 1.8V$.
Full scale signal in every path, $20k\Omega$ load at analog outputs.

No master clock

Table 37. Typical power dissipation, no master clock

N.	Function	CR0-CR2 setting	Other settings	Supply	Current	Power
1	Power Down	CR0=0x00 CR1=0x00 CR2=0x00		Analog: Digital: Total:	0.02 μA 0.20 μA	0.05 μW 0.36 μW 0.41 μW
2	Stereo analog path (Mic-LO)	CR0=0xD0 CR1=0x0C CR2=0xC0	MICLO=1 MICSEL=2	Analog: Digital: Total:	4.3 mA 2.0 μA	11.6 mW 0.0 mW 11.6 mW
3	Stereo analog path (Mic-Mixer-LO)	CR0=0xD0; CR1=0x0C; CR2=0xC3	MIXMIC=1 MICSEL=2	Analog: Digital: Total:	5.4 mA 2.0 μA	14.6 mW 0.0 mW 14.6 mW

Master clock AMCK = 13 MHz

Table 38. Typical power dissipation with master clock AMCK = 13 MHz

N.	Function	CR0-CR2 setting	Other settings	Supply	Current	Power
4	Power Down	CR0=0x00 CR1=0x00 CR2=0x00		Analog: Digital: Total:	0.02 μ A 2.20 μ A	0.05 μ W 3.96 μ W 4.01 μW
5	Stereo ADC	CR0=0xE8 CR1=0xCC CR2=0x00	MICSEL=1 ADMIC=1	Analog: Digital: Total:	7.9 mA 2.8 mA	21.3 mW 5.0 mW 26.3 mW
6	Stereo DAC	CR0=0xE8 CR1=0x30 CR2=0x33	MIXDAC=1	Analog: Digital: Total:	6.1 mA 3.8 mA	16.5 mW 6.8 mW 23.3 mW
7	Stereo analog path (Mic-LO)	CR0=0xE8 CR1=0x0C CR2=0xC0	MICLO=1 MICSEL=2	Analog: Digital: Total:	4.8 mA 0.8 mA	13.0 mW 1.4 mW 13.8 mW
8	Stereo ADC Stereo DAC	CR0=0xE8 CR1=0xFC CR2=0x33	MICSEL=2 ADMIC=1 MIXDAC=1	Analog: Digital: Total:	13.5 mA 5.8 mA	36.5 mW 10.4 mW 46.9 mW
9	Stereo ADC Stereo DAC Stereo analog path	CR0=0xE8 CR1=0xFF CR2=0xF3	LINSEL=2; MICSEL=2 ADLIN=1; MIXDAC=1 MICLO=1	Analog: Digital: Total:	15.2 mA 5.8 mA	41.0 mW 10.4 mW 51.4 mW
10	Voice TX+RX	CR0=0xE8 CR1=0xA8 CR2=0x06	MICSEL=2; LSMODE=2 ADMIC=1 MIXDAC=1 ADVOICE=1 DAVOICE=1	V_{CCA}, V_{CCP} : V_{CCLS} : Digital Total:	6.8 mA 1.3 mA 2.5 mA	18.4 mW 5.5 mW 4.5 mW 28.4 mW

10 Electrical characteristics

Unless otherwise specified, $V_{CCIO} = 1.71V$ to $2.7V$, $T_{amb} = -30^{\circ}C$ to $85^{\circ}C$; typical characteristic are specified at $V_{CCIO} = 2.0V$, $T_{amb} = 25^{\circ}C$; all signals are referenced to GND.

10.1 Digital interfaces

Table 39. Digital interfaces specifications

Symbol	Parameter	Test conditions	Min.	Typ.	Max.	Unit
V_{IL}	Input low voltage	All digital inputs	DC		$0.3 \cdot V_{CCIO}$	V
			AC		$0.2 \cdot V_{CCIO}$	V
V_{IH}	Input high voltage	All digital inputs,	DC	$0.7 \cdot V_{CCIO}$		V
			AC	$0.8 \cdot V_{CCIO}$		V
V_{OL}	Output low voltage	All digital outputs	$I_L = 10\mu A$		0.1	V
			$I_L = 2\mu A$		0.4	V
V_{OH}	Output high voltage	All digital outputs	$I_L = 10\mu A$	$V_{CCIO}-0.1$		V
			$I_L = 2\mu A$	$V_{CCIO}-0.4$		V
I_{IL}	Input low current	Any digital input, $GND < V_{IN} < V_{IL}$	-1		1	μA
I_{IH}	Input high current	Any digital input, $V_{IH} < V_{IN} < V_{CCIO}$	-1		1	μA
I_{OZ}	Output current in high impedance (Tristate)	Tristate outputs	-1		1	μA

Note: See [Figure 13: A.C. testing input-output waveform on page 58](#).

10.2 AMCK with sinusoid input

Table 40. AMCK with sinusoid input specifications

Symbol	Parameter	Test conditions	Min.	Typ.	Max.	Unit
C_{AMCK}	Minimum External Capacitance	AMCKSIN=1, see CR30	100			pF
V_{AMCK}	AMCK sinusoidal voltage swing	AMCKSIN=1, see CR30	0.5		V_{CCIO}	V_{PP}

10.3 Analog interfaces

Information below is for each entity.

Table 41. Analog interface specifications

Symbol	Parameter	Test conditions	Min.	Typ.	Max.	Unit
I_{MIC}	MIC input leakage	$GND < V_{MIC} < V_{CCA}$	-100		+100	μA
R_{MIC}	MIC input resistance		30	50		$k\Omega$
R_{LIN}	Line in input resistance		30			$k\Omega$
R_{LHP}	Headphones (HP) drivers load resistance	HPL, HPR to GNDP or VCMHP	14.4	16/32		Ω
R_{LEAR}	Earphone (EAR) drivers load resistance	1 EARP to 1EARN	30	32		Ω
R_{LLS}	Loudspeaker (LS) drivers load resistance	2LSP to 2LSN	6.4	8		Ω
C_{LHP}	Headphones (HP) drivers load capacitance	HPL, HPR to GNDP or VCMHP			50 50*	pF nF
C_{LEAR}	Earphone (EAR) drivers load capacitance	1 EARP to 1EARN			50 50*	pF nF
C_{LLS}	Loudspeaker (LS) drivers load capacitance	2LSP to 2LSN			50 50*	pF nF
V_{OFFLS}	Differential offset voltage at 2LSP, 2LSN	$R_L = 50\Omega$	-50		+50	mV
V_{OFFEAR}	Differential offset voltage at 1EARP, 1EARN	$R_L = 50\Omega$	-50		+50	mV
R_{LOL}	Line out (OL) diff./single-ended driver load resistance	OLP/ORP to OLN/ORN or OLP/ORP to GND (decoupled)	1			$k\Omega$

* with series resistor

10.4 Headset plug-in and push-button detector

Information below is for each entity.

Table 42. Headset plug-in and push-button detector specifications

Symbol	Parameter	Test conditions	Min.	Typ.	Max.	Unit
HD _{VL}	Plug-in detected	Voltage at HDET			V _{CCA} -1	V
HD _{VH}	Plug-in undetected	Voltage at HDET	V _{CCA} -0.5			V
HD _H	Plug-in detector hysteresis			100		mV
PB _{VL}	Push-button pressed	Voltage at HDET			0.5	V
PB _{VH}	Push-button released	Voltage at HDET	1			V
PB _D	Push-button de-bounce time		15		50	ms

10.5 Microphone bias

Information below is for each entity.

Table 43. Microphone bias specifications

Symbol	Parameter	Test conditions	Min.	Typ.	Max.	Unit
V _{MBIAS}	MBIAS output voltage		1.95	2.1	2.25	V
I _{MBIAS}	MBIAS output current	From MBIAS to ground			1.1	mA
R _{MBIAS}	MBIAS output load		3.5			kΩ
C _{MBIAS}	MBIAS output capacitance				150	pF
PSR _{MB4} PSR _{MB20}	MBIAS power supply rejection	f<4kHz f<20kHz	60 50			dB dB

10.6 Power supply rejection ratio

Table 44. Power supply rejection ratio specifications

Symbol	Parameter	Test conditions	Min.	Typ.	Max.	Unit
PSR _{L20} PSR _{L200}	PSRR V _{CCLS}	Each output (LSP, LSN) f<20kHz f<200kHz		65 47		dB dB
PSR _{PH} PSR _{POS} PSR _{POD}	PSRR V _{CCP}	Headphones f<20kHz Line out single ended f<20kHz Line out differential f<20kHz		65 65 65		dB dB dB
PSR _{AM} PSR _{AL}	PSRR V _{CCA}	Mic input f<20kHz Line In f<20kHz		50 50		dB dB

10.7 LS and EAR gain limiter

Information below is for each entity.

Table 45. LS and EAR gain limiter

Symbol	Parameter	Test conditions	Min.	Typ.	Max.	Unit
VLS _{LIMH}	High voltage at V _{CCLS} (VLSH=1)	V _{CCLS} raising		4.2		V
VLS _{LIML}	Low voltage at V _{CCLS} (VLSH=0)	V _{CCLS} falling		4.0		V
VLS _{LIMD}	V _{CCLS} Hysteresis			200		mV

Note: See CR32 for VLSH definition. See Loudspeaker driver description in [Section 4.10](#) for details.

11 Analog input/output operative ranges

Information included in this section applies to both entities.

11.1 Analog levels

Table 46. Reference full scale analog levels

Symbol	Parameter	Test conditions	Min.	Typ.	Max.	Unit
	0dBFS level	$2.7V < V_{CCA} < 3.3V$		12 4		dBV_{pp} V_{pp}
	0dBFS level low voltage mode	$2.4V < V_{CCA} < 2.7V$		10 3.18		dBV_{pp} V_{pp}

11.2 Microphone input levels

Analog supply range: $2.7V < V_{CCA} < 3.3V$

Table 47. Microphone input levels, absolute levels at pins connected to preamplifiers

Symbol	Parameter	Test conditions	Min.	Typ.	Max.	Unit
	Overload level, single ended	MIC gain = 0 to 6dB		707 2 -6		mV_{RMS} V_{pp} dBFS
	Overload level, single ended, versus MIC gain	MIC gain > 6dB	-(MIC_Gain)			dBFS
	Overload level, differential	MIC gain = 0dB		1.41 4 0		mV_{RMS} V_{pp} dBFS
	Overload level, differential, versus MIC gain	MIC gain > 0dB	-(MIC_Gain)			dBFS

Note: When $2.4V < V_{CCA} < 2.7V$, voltage values are reduced by 2dB.

Table 48. Microphone input levels, absolute levels at pins connected to the line-in amplifiers

Symbol	Parameter	Test conditions	Min.	Typ.	Max.	Unit
	Overload level, single ended	Line in gain from -20dB to 6dB		707 2 -6		mV_{RMS} V_{pp} dBFS
	Overload level (single ended) versus line in gain	Line in gain > 6dB	-(Line_In_Gain)			dBFS
	Overload level (differential)	Line in gain from -20dB to 0dB		1.41 4 0		mV_{RMS} V_{pp} dBFS

Table 48. Microphone input levels, absolute levels at pins connected to the line-in amplifiers

Symbol	Parameter	Test conditions	Min.	Typ.	Max.	Unit
	Overload level (differential) versus line in gain	Line in gain > 0dB			-(Line_In_Gain)	dBFS

Note: When $2.4\text{ V} < V_{CCA} < 2.7\text{ V}$, the values are reduced by 2dB

11.3 Line output levels

Analog supply range: $2.7\text{ V} < V_{CCA} < 3.3\text{ V}$

Table 49. Absolute levels at OLP/OLN, ORP/ORN

Symbol	Parameter	Test conditions	Min.	Typ.	Max.	Unit
	Output level, single ended	0 dB gain Full scale digital input		707 2 -6		mV_{RMS} V_{pp} dBFS
	Output level, differential	0 dB gain Full scale digital input		1.41 4 0		mV_{RMS} V_{pp} dBFS

Note: When $2.4\text{ V} < V_{CCA} < 2.7\text{ V}$, the values are reduced by 2dB

11.4 Power output levels HP

Analog supply range: $2.7\text{ V} < V_{CCA} < 3.3\text{ V}$

Table 50. Absolute levels at HPL - HPR

Symbol	Parameter	Test conditions	Min.	Typ.	Max.	Unit
	Output level	-6dB gain Full scale digital input		707 2 -6		mV_{RMS} V_{pp} dBFS
	Max output power ⁽¹⁾	16 Ω load $V_{CCP} > 3.2\text{ V}$	40			mW

1. In some operating conditions the maximum output power can be limited. See "[Section 9.1: Absolute maximum ratings](#)" and "loudspeaker driver" description from [Section 4.10: Analog output drivers](#) for details.

Note: When $2.4\text{ V} < V_{CCA} < 2.7\text{ V}$, the values are reduced by 2dB

11.5 Power output levels LS and EAR

Analog supply range: $2.7\text{ V} < V_{CCA} < 3.3\text{ V}$

Table 51. Absolute levels at 1EARP-1EARN and 2LSP - 2LSN

Symbol	Parameter	Test conditions	Min.	Typ.	Max.	Unit
	Output level	0 dB gain Full scale digital input		1.41 4 0		V_{RMS} V_{pp} dBFS
	Max EAR output power	32 Ω load $V_{CCLS} > 4V$	125			mW
	Max LS output power ⁽¹⁾	8 Ω load $V_{CCLS} > 4V$	500			mW

1. In some operating conditions the maximum output power can be limited. See "[Section 9.1: Absolute maximum ratings](#)" and "loudspeaker driver" description from [Section 4.10: Analog output drivers](#) for details.

Note: When $2.4 V < V_{CCA} < 2.7 V$, the values are reduced by 2dB

12 Stereo audio ADC specifications

Information included in this section applies to both entities. Typical measures at $V_{CCA}=V_{CCP}=V_{CCLS}=2.7V$; $V_{CCIO}=V_{CC}=1.8V$; $T_{amb}=25^{\circ}C$; 13 MHz AMCK

Table 52. Stereo audio ADC specifications

Symbol	Parameter	Test conditions	Min.	Typ.	Max.	Unit
ADN	Resolution				20	Bits
ADDRM ADDRLI	Dynamic range	20Hz to 20kHz, A-weighted Measured at -60dBFS MIC input, 21dB gain Line-In, 0dB gain	87 89	91 93		dB dB
ADSNA ADSN	Signal to noise ratio	Max level at MIC input, 21dB gain A-weighted Unweighted (20 Hz to 20 kHz)		90 86		dB dB
	Input referred ADC noise	A-weighted Mic input 0dB gain Mic input 21dB gain Mic input 39dB gain Line in input 0dB gain Line in input 18dB gain		37 3.3 1.9 30 7.5		μV μV μV μV μV
ADTHD	Total harmonic distortion	Max level at MIC input, 21dB gain		0.001	0.003	%
	Deviation from linear phase	Measurement bandwidth 20Hz to 20kHz, $F_s=48kHz$. Combined digital and analog filter characteristics			1	Deg
ADf _{PB}	Passband	Combined digital and analog filter characteristics AD96K=0	0		0.45Fs	kHz
	Passband ripple	Combined digital and analog filter characteristics AD96K=0			0.2	dB
ADf _{SB}	Stopband	Combined digital and analog filter characteristics AD96K=0	0.55Fs			kHz
	Stopband Attenuation	Measurement bandwidth up to 3.45Fs. Combined digital and analog filter characteristics, AD96K=0	60			dB
ADt _{gd}	Group delay	Audio filters, 96kHz FS Audio filters, 48kHz FS Audio filters, 8kHz FS		0.11 0.4 2.6		ms ms ms
	Interchannel isolation			90		dB
	Interchannel gain mismatch				0.2	dB
	Gain error				0.5	dB

Note: When $2.4V < V_{CCA} < 2.7V$, the values are reduced by 2dB

13 Stereo audio DAC specifications

Information included in this section applies to both entities.

Typical measures at $V_{CCA}=V_{CCP}=V_{CCLs}=2.7V$; $V_{CCIO}=V_{CC}=1.8V$; $T_{amb}=25^{\circ}C$; 13MHz AMCK

Table 53. Stereo audio DAC specifications

Symbol	Parameter	Test conditions	Min.	Typ.	Max.	Unit	
DAN	Resolution				20	Bits	
DADR	Dynamic range	20Hz to 20kHz, A-weighted. Measured at -60dBFS	90	95		dB	
		Differential line out					93
		Single-ended line out					94
		HPL/HPR to GND or VCMHP LSP-LSN					94
DASNA DASN	Signal to noise ratio	2V _{pp} output HPL, HPR gain set to -6dB, 16Ω load		94		dB	
		A-weighted Unweighted (20 Hz to 20 kHz)					90
DATHDL	Total harmonic distortion Worst case load	2V _{pp} output HPL, HPR gain set to -6dB, 16Ω load		0.02	0.04	%	
DATHD	Total harmonic distortion	2V _{pp} output, HPL, HPR gain set to -6dB, 1kΩ load		0.004		%	
	Deviation from linear phase	Measurement bandwidth 20Hz to 20kHz, F _s = 48kHz. Combined digital and analog filter characteristics			1	Deg	
DA _{fPB}	Passband	Combined digital and analog filter characteristics, DA96K=0	0		0.45F _s	kHz	
	Passband ripple	Combined digital and analog filter characteristics, DA96K=0			0.2	dB	
DA _{fSB}	Stopband	Combined digital and analog filter characteristics, DA96K=0	0.55F _s			kHz	
	Stopband attenuation	Measurement bandwidth up to 3.45F _s . Combined digital and analog filter characteristics, DA96K=0	50			dB	
TSF	Transient suppression filter cut-off frequency		15		23	Hz	
	Out of band noise	Measurement bandwidth 20 kHz to 100 kHz. Zero input signal		-85		dBr	

Table 53. Stereo audio DAC specifications (continued)

Symbol	Parameter	Test conditions	Min.	Typ.	Max.	Unit
DA _{tgd}	Group delay	Audio filters, 96kHz FS		0.09		ms
		Audio filters, 48kHz FS		0.4		ms
		Audio filters, 8kHz FS		2.6		ms
	Interchannel isolation	2Vpp output HPR, HPL unloaded		100		dB
		HPR, HPL with 16Ω to VCMHP		60		dB
	Interchannel gain mismatch				0.2	dB
	Gain error				0.5	dB
SUT	Startup time from power up	FS=48 kHz		1		ms
		Line out HPL/R out		10		ms

Note: When $2.4\text{ V} < V_{CCA} < 2.7\text{ V}$, values are reduced by 2 dB

14 AD to DA mixing (sidetone) specifications

Information included in this section applies to both entities.

Typical measures at $V_{CCA}=V_{CCP}=V_{CCLS}=2.7\text{V}$; $V_{CCIO}=V_{CC}=1.8\text{V}$; $T_{amb}=25^\circ\text{C}$; 13MHz AMCK.

Table 54. AD to DA mixing (sidetone) specifications

Symbol	Parameter	Test conditions	Min.	Typ.	Max.	Unit
STDEL	AD to DA mixing (sidetone) delay	Valid for audio and voice filters		5	10	μs

15 Stereo analog-only path specifications

Information included in this section applies to both entities.

Measured at differential line-out, ENOSC=1, No master clock.

Typical measures at $V_{CCA}=V_{CCP}=V_{CCLS}=2.7V$; $V_{CCIO}=V_{CC}=1.8V$; $T_{amb}=25^{\circ}C$

Table 55. Stereo analog-only path specifications

Symbol	Parameter	Test conditions	Min.	Typ.	Max.	Unit
AADRM AADRLI	Dynamic range	20Hz to 20kHz, A-weighted. Measured at -60dBFS MIC input, 21dB gain Line-In, 0dB gain	90 90	95 97		dB dB
AASNA AASN	Signal to noise ratio	Max level at line-in input, 0dB gain, A-weighted Unweighted (20 Hz to 20 kHz)		97 94		dB dB
AATHD	Total harmonic distortion	1kHz @ 0dBFS MIC input, 21dB gain Line-in input, 0dB gain		0.003 0.004	0.01 0.02	% %

Note: When $2.4V < V_{CCA} < 2.7V$, the values are reduced by 2dB.

16 ADC (TX) & DAC (RX) specifications with voice filters selected

Information included in this section applies to both entities.

Typical measures at $V_{CCA}=V_{CCP}=V_{CCL}=2.7V$; $V_{CCIO}=V_{CC}=1.8V$; $T_{amb}=25^{\circ}C$; 13MHz
AMCK

Table 56. ADC (TX) & DAC (RX) specifications with voice filters selected

Symbol	Parameter	Test conditions	Min.	Typ.	Max.	Unit
TXDR RXDR	Dynamic range	300Hz to 3.4kHz; 1kHz @ -60dBFS TX Path, MIC input, 21dB gain RX Path, LS Output, 0dB gain	86 83	89 86		dB dB
TXSN RXSN	Signal to noise ratio	300Hz to 3.4kHz; 1kHz @ 0dBFS TX Path, MIC input, 21dB gain RX Path, LS and EAR outputs, 0dB gain		88 86		dB dB
THD	THD	1kHz @ 0dBFS TX Path, MIC input, 21dB gain RX Path, LS and EAR outputs, 0dB gain		<0.001 0.005		% %
TXG	TX gain mask	f=60Hz			-30	dB
		f=100Hz			-24	dB
		f=200Hz			-6	dB
		f=300Hz	-1.5		0.5	dB
		f=400Hz-3000Hz	-0.5		0.5	dB
		f=3400Hz	-1.5		0.0	dB
		f=4000H			-14	dB
		f=4600Hzz f=8000Hz			-35 -47	dB dB
RXG	RX gain mask	f=60Hz			-20	dB
		f=100Hz			-12	dB
		f=200Hz			-2	dB
		f=300Hz	-1.5		0.5	dB
		f=400Hz-3000Hz	-0.5		0.5	dB
		f=3400Hz	-1.5		0.0	dB
		f=4000Hz			-14	dB
		f=5000Hz			-50	dB
	RX out of band noise	Measurement bandwidth 4kHz to 100kHz. Zero input signal		-85		dB _r
	Group delay	TX path		0.32		ms
RX path			0.28		ms	

Note: When $2.4V < V_{CCA} < 2.7V$, the values are reduced by 2dB

17 Typical performance plots

Figure 14. Bass treble control, de-emphasis filter

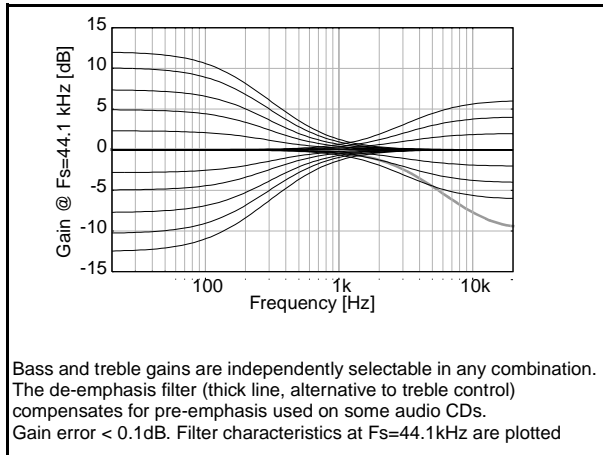

Figure 15. Dynamic compressor transfer function

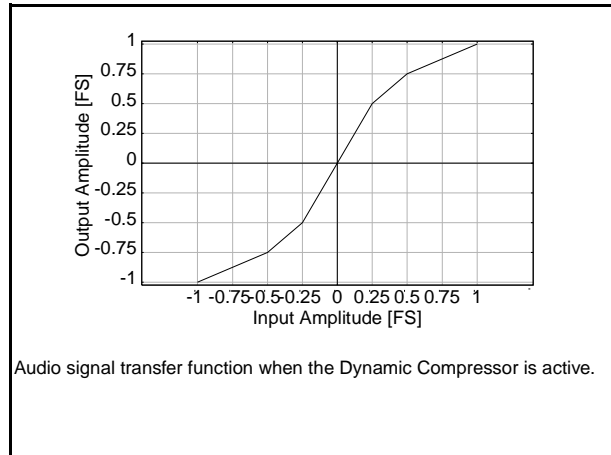

Figure 16. ADC audio path measured filter response

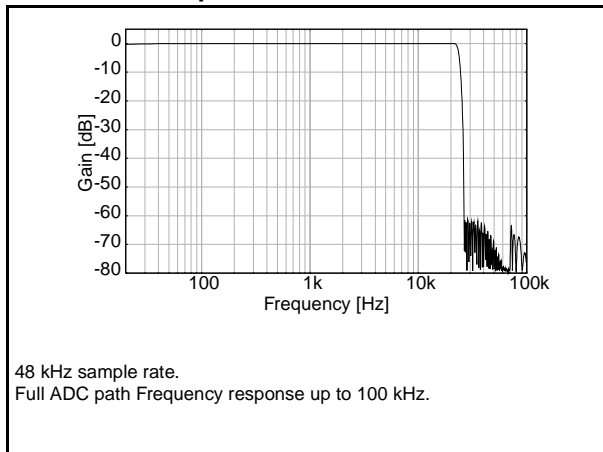

Figure 17. ADC in band audio path measured filter response

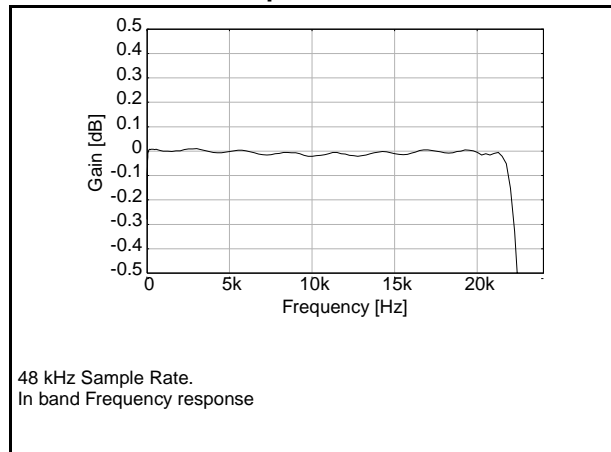

Figure 18. DAC digital audio filter characteristics

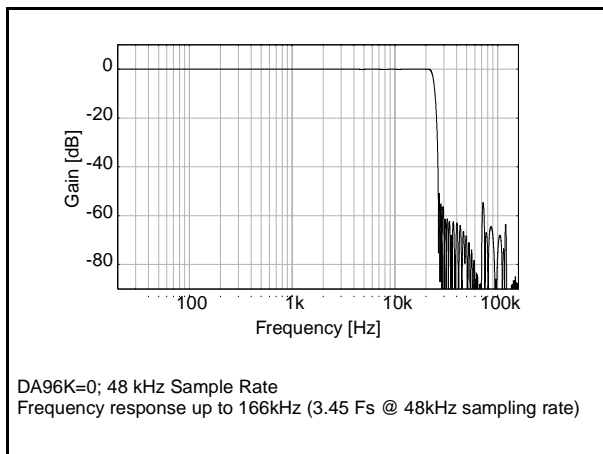

Figure 19. DAC in band digital audio filter characteristics

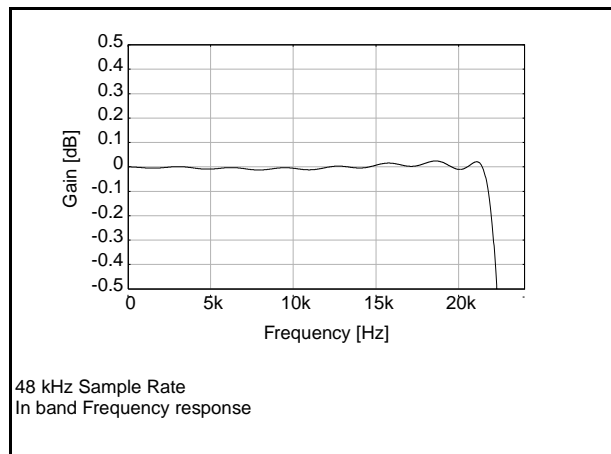

Figure 20. ADC 96 kHz audio path measured filter response

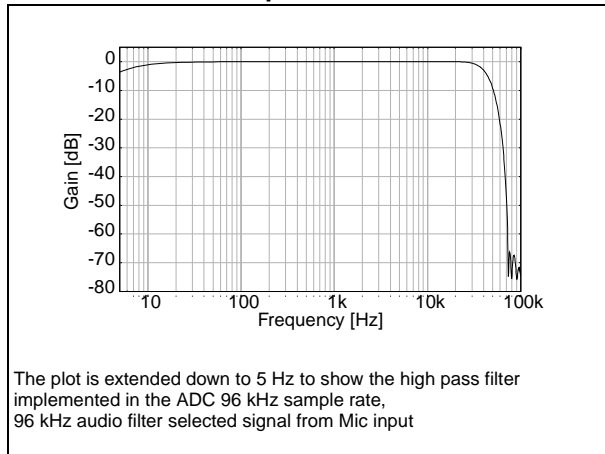

Figure 21. ADC 96 kHz audio in-band measured filter response

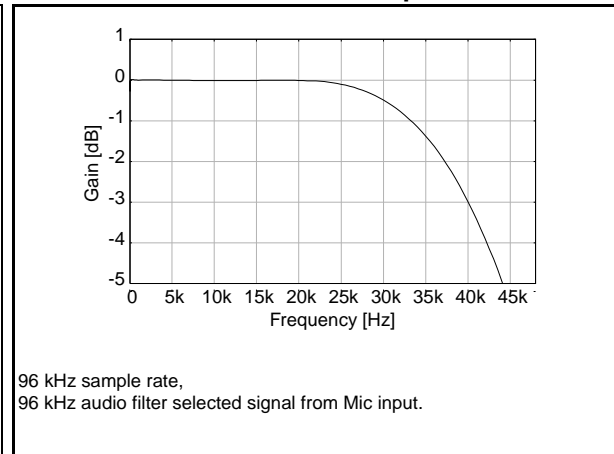

Figure 22. ADC voice TX path measured filter response

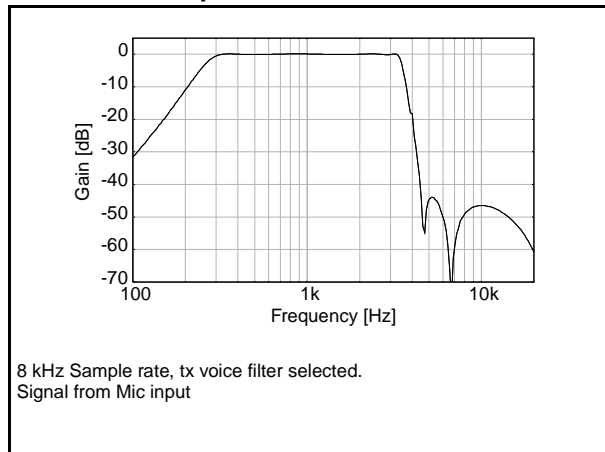

Figure 23. ADC voice TX path measured in-band filter response

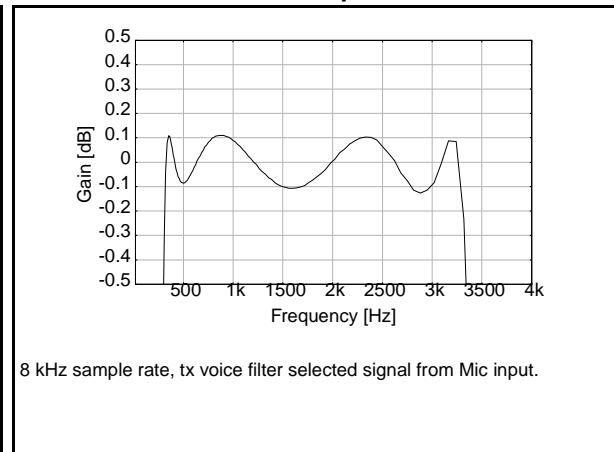

Figure 24. DAC voice (RX) digital filter characteristics

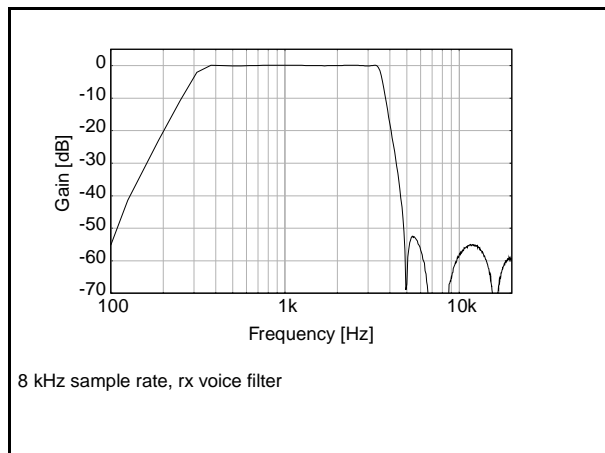

Figure 25. DAC voice (RX) in-band digital filter characteristics

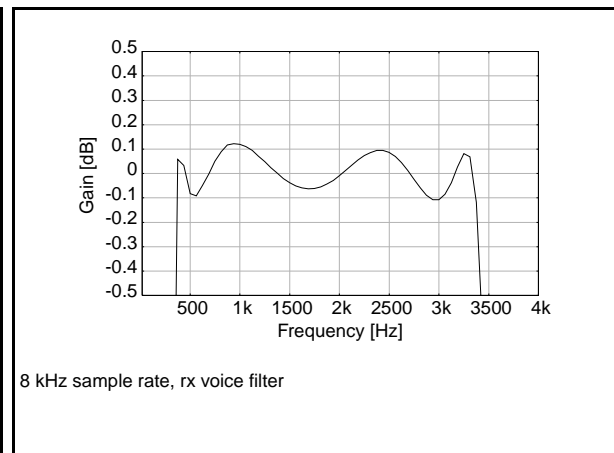

Figure 26. ADC path FFT

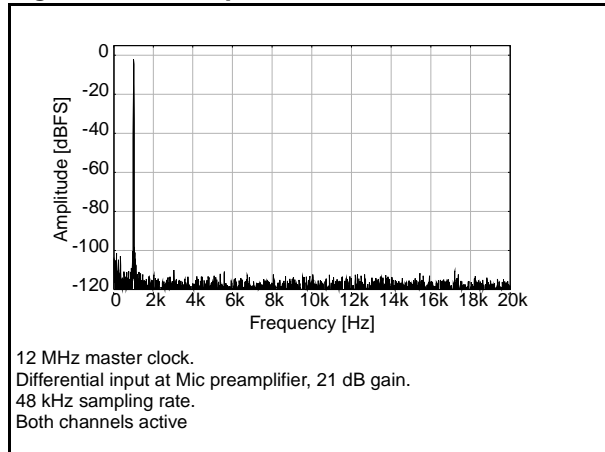

Figure 27. ADC S/N versus input-level

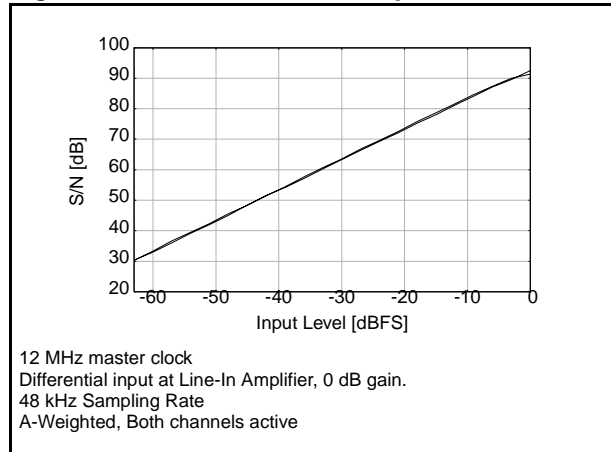

Figure 28. DAC path FFT

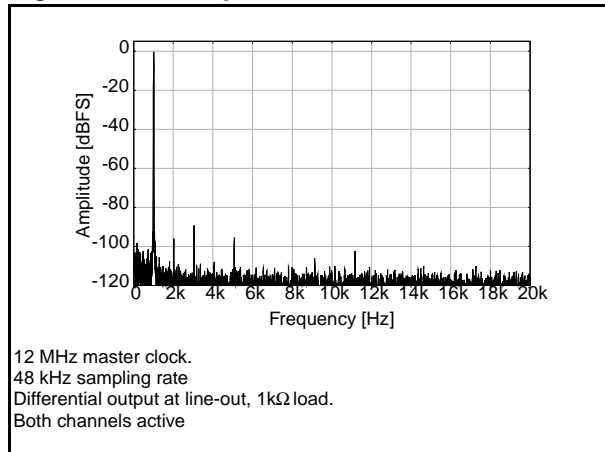

Figure 29. DAC S/N versus input-level

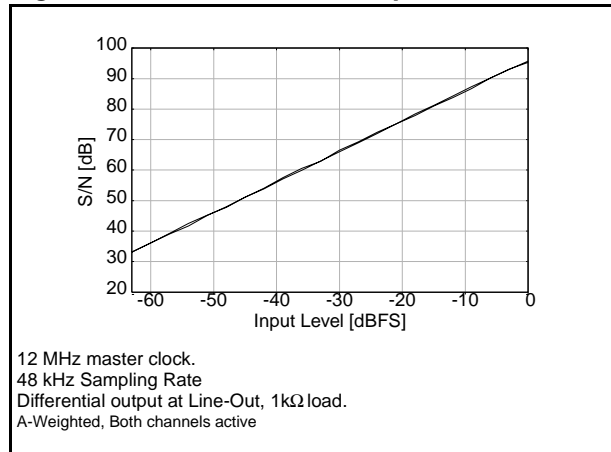

Figure 30. Analog path FFT

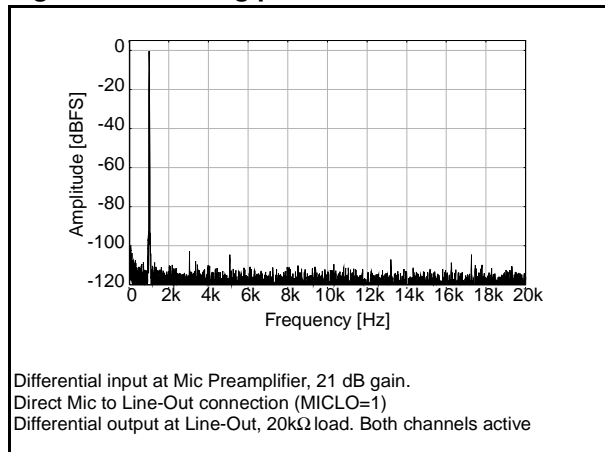
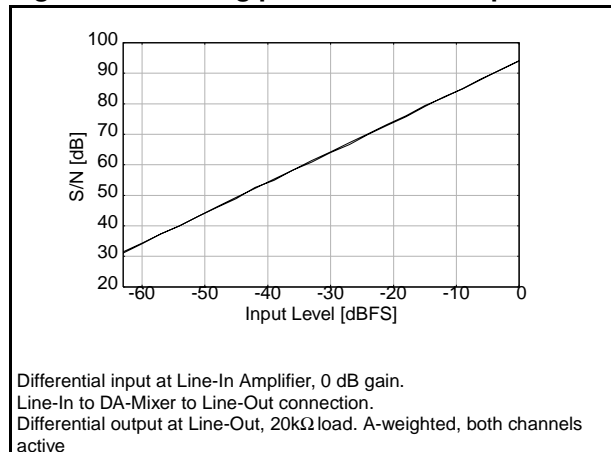

Figure 31. Analog path S/N versus input-level



18 Package mechanical data

In order to meet environmental requirements, ST offers these devices in ECOPACK® packages. These packages have a Lead-free second level interconnect. The category of second Level Interconnect is marked on the package and on the inner box label, in compliance with JEDEC Standard JESD97. The maximum ratings related to soldering conditions are also marked on the inner box label. ECOPACK is an ST trademark. ECOPACK specifications are available at: www.st.com.

18.1 LFBGA 6x6x1.4

Table 57. Dimensions of LFBGA 6x6x1.4 112 4R11x11. 0.5

Reference	Databook (mm)			Drawing (mm)			Notes
	Min.	Typ.	Max.	Min.	Typ.	Max.	
A			1.40			1.26	Note 1
A1	0.15			0.16	0.21	0.26	
A2		0.985		0.93	0.985	1.04	
A3		0.20		0.16	0.20	0.24	
A4			0.80	0.77	0.785	0.80	
b	0.25	0.30	0.35	0.25	0.30	0.35	Note 2
D	5.85	6.00	6.15	5.90	6.00	6.10	
D1		5.00			5.00		
E	5.85	6.00	6.15	5.90	6.00	6.10	
E1		5.00			5.00		
e		0.50			0.50		
F		0.50			0.50		
ddd			0.08			0.08	
eee			0.15			0.15	Note 4
fff			0.05			0.05	Note 5

- Note:**
- 1 *LFBGA stands for Low Profile Fine Pitch Ball Grid Array.*
 - Low profile: the total profile height (Dim A) is measured from the seating plane to the top of the component. The maximum total package height is calculated as follows:
 $A_{2Typ} + A_{1Typ} + \sqrt{(A_1^2 + A_3^2 + A_4^2 \text{tolerancevalues})}$. Fine pitch: $e < 1.0$ mm pitch
 - 2 *The typical ball diameter before mounting is 0.30 mm*
 - 3 *The tolerance of position that controls the location of the pattern of balls with respect to datum A and B. For each ball there is a cylindrical tolerance zone eee perpendicular to datum C and located on true position with respect to datum A and B as defined by e. The axis perpendicular to datum C of each ball must lie within this tolerance zone.*
 - 4 *The tolerance of position that controls the location of the balls within the matrix with respect to each other. For each ball there is a cylindrical tolerance zone fff perpendicular to datum C and located on true position as defined by e. The axis perpendicular to datum C of each ball must lie within this tolerance zone. Each tolerance zone fff in the array is contained entirely in the respective zone eee above.
 The axis of each ball must lie simultaneously in both tolerance zones.*
 - 5 *The terminal A1 corner must be identified on the top surface by using a corner chamfer, ink or metallized markings, or other feature of package body or integral heatslug. A distinguishing feature is allowable on the bottom surface of the package to identify the terminal A1 corner. Exact shape of each corner is optional.*

Figure 32. LFBGA 6x6x1.4 112 4R11x11 0.5 drawing

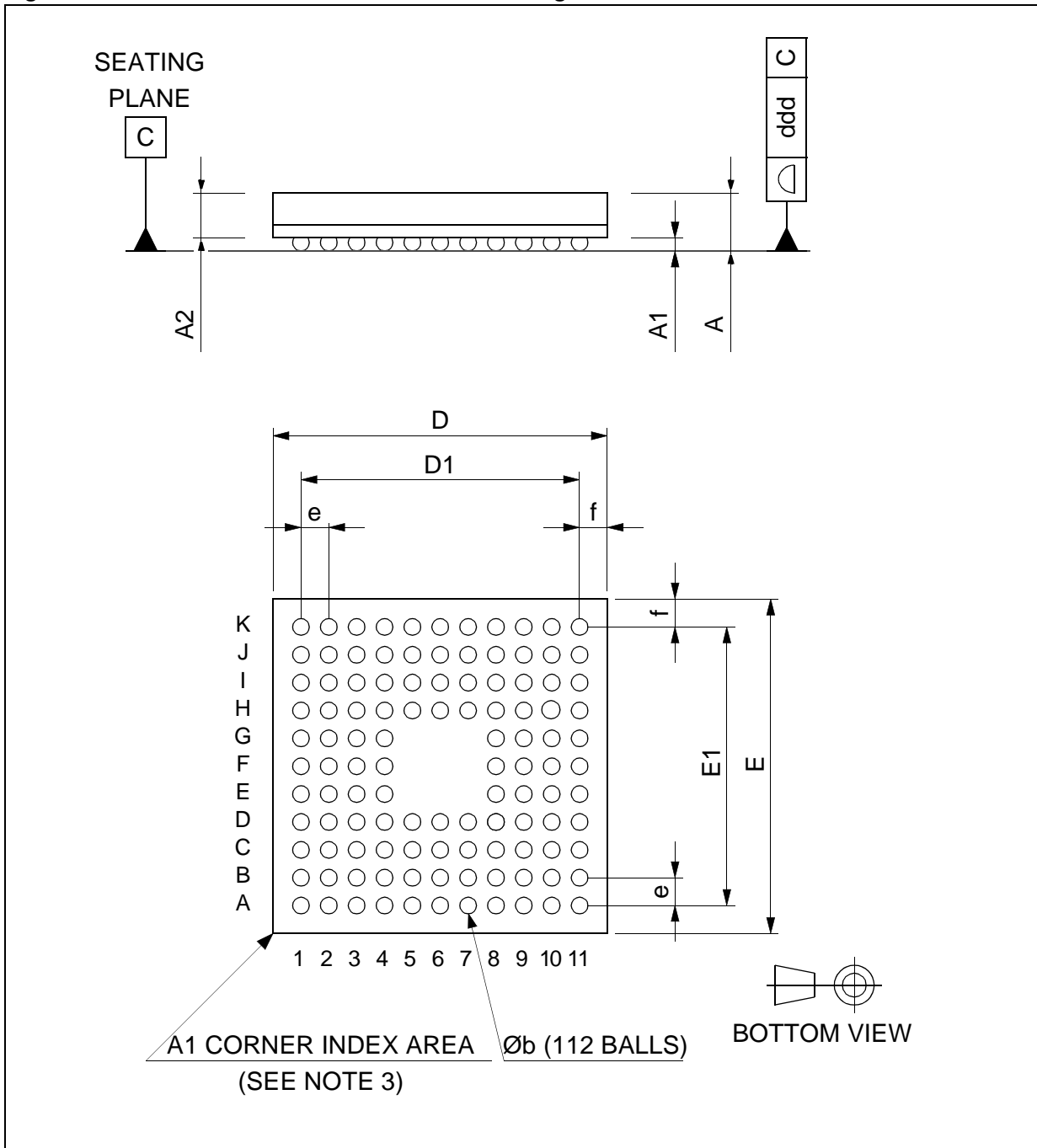

18.2 VFBGA 5x5x1.0

Table 58. Dimensions of VFBGA 5x5x1.0 112 balls 0.4 mm pitch

Reference	Databook (mm)			Drawing (mm)			Notes
	Min.	Typ.	Max.	Min.	Typ.	Max.	
A			1.00			0.99	Note 1
A1	0.125			0.125	0.165	0.205	
A2		0.765		0.71	0.765	0.82	
A3		0.18		0.14	0.18	0.22	
A4			0.60	0.57	0.585	0.60	
b	0.22	0.26	0.30	0.22	0.26	0.30	Note 2
D	4.95	5.00	5.05	4.95	5.00	5.05	
D1		4.00			4.00		
E	4.95	5.00	5.05	4.95	5.00	5.05	
E1		4.00			4.00		
e		0.40			0.40		Note 3
F		0.50			0.50		
ddd			0.08			0.08	
eee			0.13			0.13	Note 4
fff			0.04			0.04	Note 5

- Note:**
- 1 VFBGA stands for Very thin Profile Fine Pitch Ball Grid Array.
The maximum total package height is calculated by the following methodology:
 $A2Typ + A1Typ + \sqrt{(A1^2 + A3^2 + A4^2 \text{tolerance values})}$.
Very thin profile: $0.80\text{mm} < A \leq 1.00\text{mm}$ Max/Fine pitch: $e < 1.0\text{ mm}$
 - 2 The typical ball diameter before mounting is 0.25 mm
 - 3 VFBGA with 0.40mm ball pitch is not yet registered into JEDEC publications.
 - 4 The tolerance of position that controls the location of the pattern of balls with respect to datum A and B. For each ball there is a cylindrical tolerance zone eee perpendicular to datum C and located on true position with respect to datum A and B as defined by e. The axis perpendicular to datum C of each ball must lie within this tolerance zone.
 - 5 The tolerance of position that controls the location of the balls within the matrix with respect to each other. For each ball there is a cylindrical tolerance zone fff perpendicular to datum C and located on true position as defined by e. The axis perpendicular to datum C of each ball must lie within this tolerance zone. Each tolerance zone fff in the array is contained entirely in the respective zone eee above.
The axis of each ball must lie simultaneously in both tolerance zones.
 - 6 The terminal A1 corner must be identified on the top surface by using a corner chamfer, ink or metallized markings, or other feature of package body or integral heatslug. A distinguishing feature is allowable on the bottom surface of the package to identify the terminal A1 corner. Exact shape of each corner is optional.

Figure 33. VFBGA 5x5x1.0 112 0.4 drawing

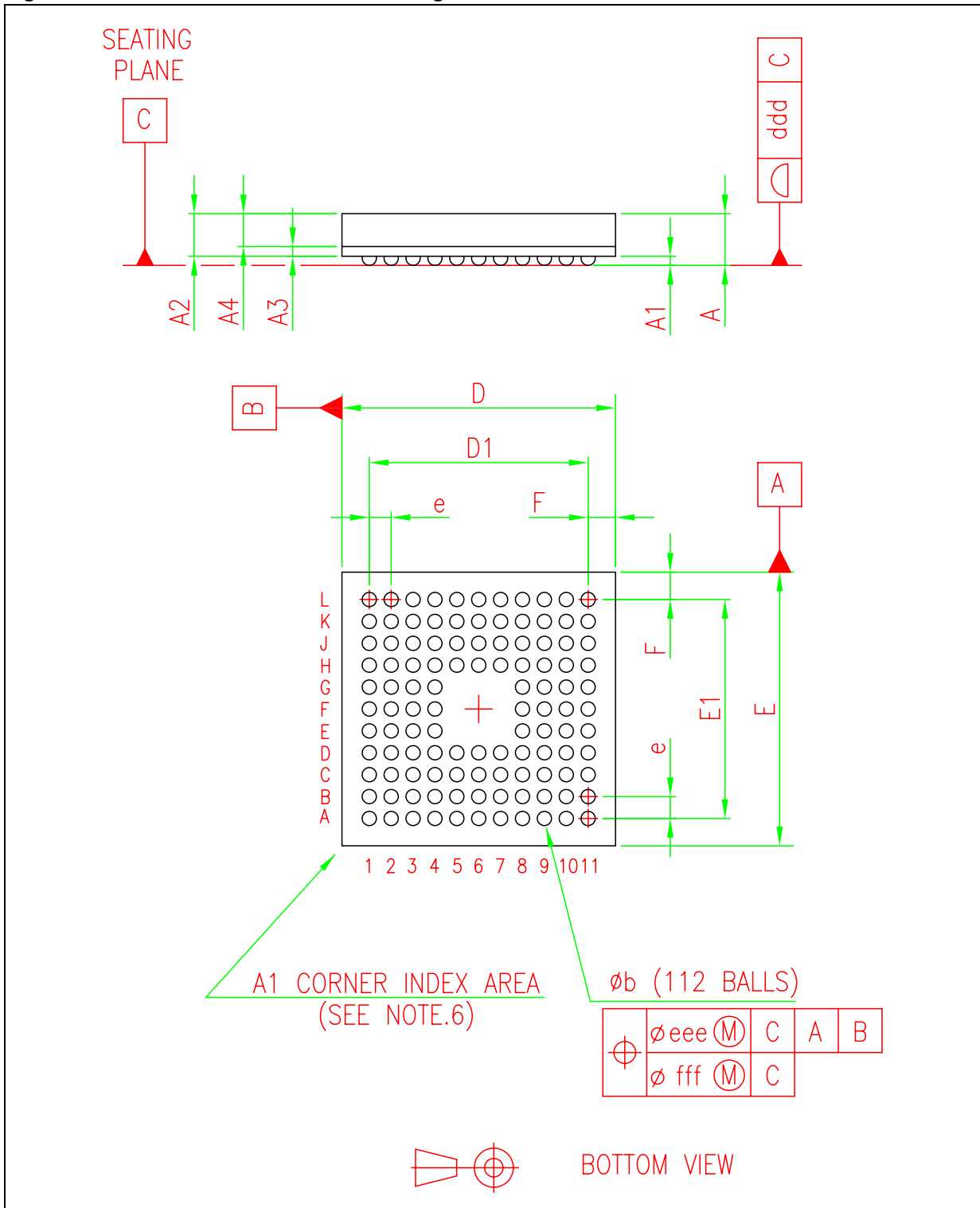

19 Application schematics

See [Figure 34: STw5098 application schematics](#).

Figure 34. STw5098 application schematics

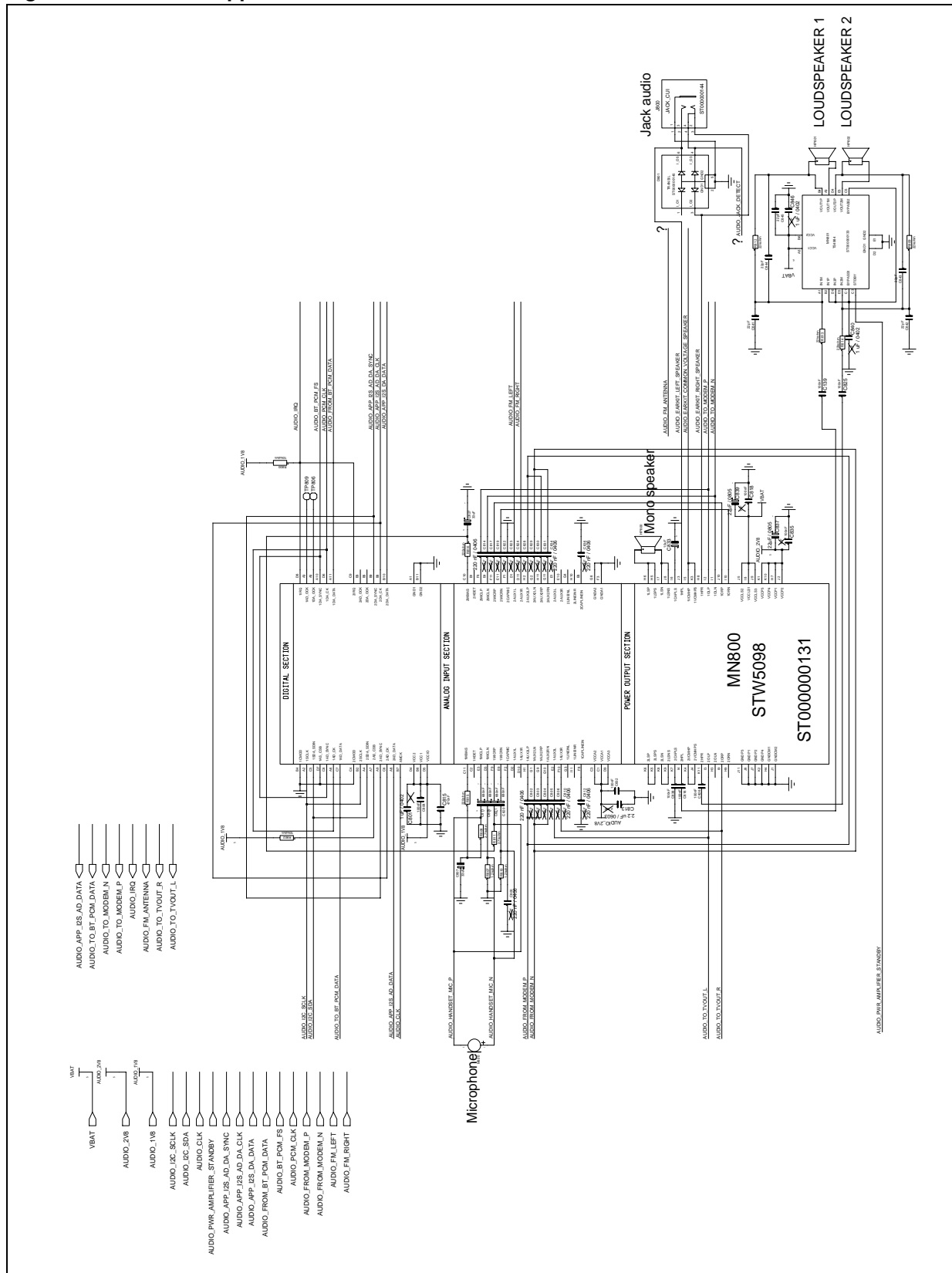

20 Ordering information

Table 59. Order codes

Part Number	Package	Packing
STw5098	LFBGA 6x6x1.4, 0.5 mm pitch, 112 pins	Tray
STw5098T	LFBGA 6x6x1.4, 0.5 mm pitch, 112 pins	Tape and reel
STw5098BBLR/LF	VFBGA 5x5x1.0, 0.4 mm pitch, 112 pins	Tray
STw5098BBLT/LF	VFBGA 5x5x1.0, 0.4 mm pitch, 112 pins	Tape and reel

21 Revision history

Table 60. Document revision history

Date	Revision	Changes
24-Apr-2007	1	Initial release.

Please Read Carefully:

Information in this document is provided solely in connection with ST products. STMicroelectronics NV and its subsidiaries ("ST") reserve the right to make changes, corrections, modifications or improvements, to this document, and the products and services described herein at any time, without notice.

All ST products are sold pursuant to ST's terms and conditions of sale.

Purchasers are solely responsible for the choice, selection and use of the ST products and services described herein, and ST assumes no liability whatsoever relating to the choice, selection or use of the ST products and services described herein.

No license, express or implied, by estoppel or otherwise, to any intellectual property rights is granted under this document. If any part of this document refers to any third party products or services it shall not be deemed a license grant by ST for the use of such third party products or services, or any intellectual property contained therein or considered as a warranty covering the use in any manner whatsoever of such third party products or services or any intellectual property contained therein.

UNLESS OTHERWISE SET FORTH IN ST'S TERMS AND CONDITIONS OF SALE ST DISCLAIMS ANY EXPRESS OR IMPLIED WARRANTY WITH RESPECT TO THE USE AND/OR SALE OF ST PRODUCTS INCLUDING WITHOUT LIMITATION IMPLIED WARRANTIES OF MERCHANTABILITY, FITNESS FOR A PARTICULAR PURPOSE (AND THEIR EQUIVALENTS UNDER THE LAWS OF ANY JURISDICTION), OR INFRINGEMENT OF ANY PATENT, COPYRIGHT OR OTHER INTELLECTUAL PROPERTY RIGHT.

UNLESS EXPRESSLY APPROVED IN WRITING BY AN AUTHORIZED ST REPRESENTATIVE, ST PRODUCTS ARE NOT RECOMMENDED, AUTHORIZED OR WARRANTED FOR USE IN MILITARY, AIR CRAFT, SPACE, LIFE SAVING, OR LIFE SUSTAINING APPLICATIONS, NOR IN PRODUCTS OR SYSTEMS WHERE FAILURE OR MALFUNCTION MAY RESULT IN PERSONAL INJURY, DEATH, OR SEVERE PROPERTY OR ENVIRONMENTAL DAMAGE. ST PRODUCTS WHICH ARE NOT SPECIFIED AS "AUTOMOTIVE GRADE" MAY ONLY BE USED IN AUTOMOTIVE APPLICATIONS AT USER'S OWN RISK.

Resale of ST products with provisions different from the statements and/or technical features set forth in this document shall immediately void any warranty granted by ST for the ST product or service described herein and shall not create or extend in any manner whatsoever, any liability of ST.

ST and the ST logo are trademarks or registered trademarks of ST in various countries.

Information in this document supersedes and replaces all information previously supplied.

The ST logo is a registered trademark of STMicroelectronics. All other names are the property of their respective owners.

© 2007 STMicroelectronics - All rights reserved

STMicroelectronics group of companies

Australia - Belgium - Brazil - Canada - China - Czech Republic - Finland - France - Germany - Hong Kong - India - Israel - Italy - Japan - Malaysia - Malta - Morocco - Singapore - Spain - Sweden - Switzerland - United Kingdom - United States of America

www.st.com