



# Technical Data Sheet

## OPTO INTERRUPTER ITR

### ITR20402

#### ■ Features

- Fast response time
- High sensitivity
- Cut-off visible wavelength  $\lambda_p=940\text{nm}$
- Thin
- Small package
- Pb free
- This product itself will remain within RoHS compliant version

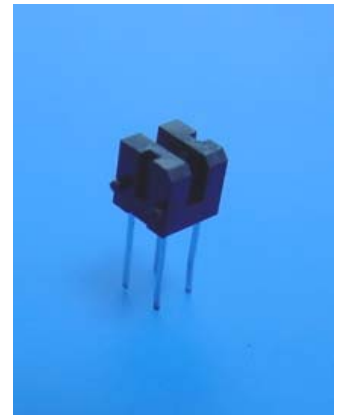

#### ■ Descriptions

The **ITR20402** consists of an infrared emitting Diode and a silicon phototransistor encased in a black Thermo-plastic housing. The advantage of the device is the small package. Phototransistor receives radiation from the IRED only, and avoids the noise from ambient light

#### ■ Applications

- Camera
- Copier
- Scanner
- Non-contact Switching
- For Direct PC Board

#### ■ Device Selection Guide

Device No.	Chip Material
IR1918C	GaAlAs
PT1918B	Silicon

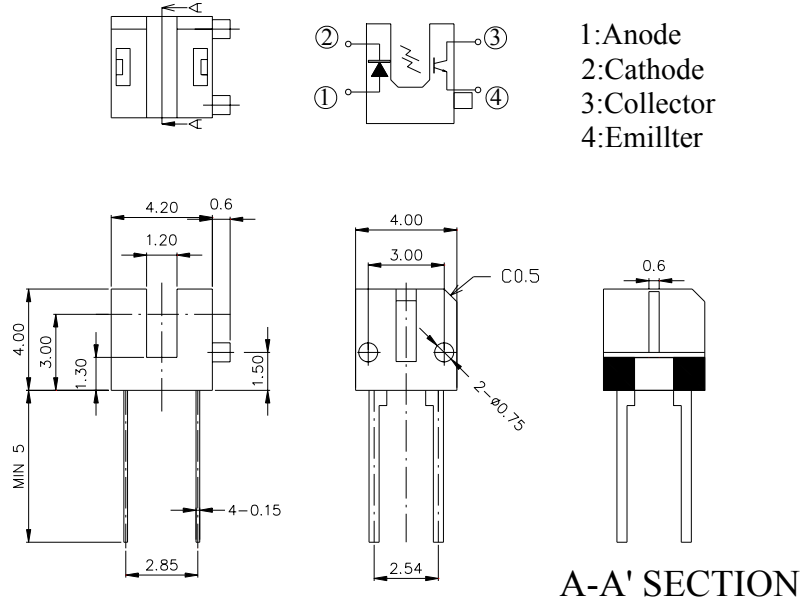
**Package Dimensions**

- Notes:** 1.All dimensions are in millimeters  
 2.Tolerances unless dimensions  $\pm 0.25\text{mm}$

**Absolute Maximum Ratings (Ta=25°C)**

Parameter		Symbol	Ratings	Unit
Input	Power Dissipation at(or below) 25°C Free Air Temperature	Pd	75	mW
	Reverse Voltage	V <sub>R</sub>	5	V
	Forward Current	I <sub>F</sub>	50	mA
	Peak Forward Current (*1) Pulse width $\leq 100 \mu\text{s}$ , Duty cycle=1%	I <sub>FP</sub>	1	A
Output	Collector Power Dissipation	P <sub>C</sub>	75	mW
	Collector Current	I <sub>C</sub>	20	mA
	Collector-Emitter Voltage	B V <sub>CEO</sub>	30	V
	Emitter-Collector Voltage	B V <sub>ECO</sub>	5	V
Operating Temperature		T <sub>opr</sub>	-25~+85	°C
Storage Temperature		T <sub>stg</sub>	-40~+85	°C
Lead Soldering Temperature (*2)		T <sub>sol</sub>	260	°C

(\*1)  $t_w=100 \mu\text{sec.}$ ,  $T=10 \text{msec.}$  (\*2)  $t=5 \text{Sec}$

**Electro-Optical Characteristics (Ta=25°C)**

Parameter		Symbol	Min.	Typ.	Max.	Unit	Conditions
Input	Forward Voltage	$V_F$	---	1.2	1.6	V	$I_F=20\text{mA}$
	Reverse Current	$I_R$	---	---	10	$\mu\text{A}$	$V_R=5\text{V}$
	Peak Wavelength	$\lambda_P$	---	940	---	nm	---
Output	Dark Current	$I_{CEO}$	---	1	100	nA	$V_{CE}=10\text{V}$
	C-E Saturation Voltage	$V_{CE}(\text{sat})$	---	---	0.4	V	$I_C=2\text{mA}$ $E_e=1\text{mW/cm}^2$
Transfer Characteristics	Collector Current	$I_C(\text{ON})$	0.3	---	---	mA	$V_{CE}=5\text{V}$ , $I_F=10\text{mA}$
	Leakage Current	$I_{CEOD}$	---	---	1	$\mu\text{A}$	$V_{CE}=5\text{V}$ $I_F=10\text{mA}$
	Rise time	$t_r$	---	15	---	$\mu\text{sec}$	$V_{CE}=2\text{V}$ $I_C=1\text{mA}$ $R_L=1\text{K}\Omega$
	Fall time	$t_f$	---	15	---	$\mu\text{sec}$	

**Typical Electrical/Optical/Characteristics Curves for IR**

Fig.1 Forward Current vs. Ambient Temperature

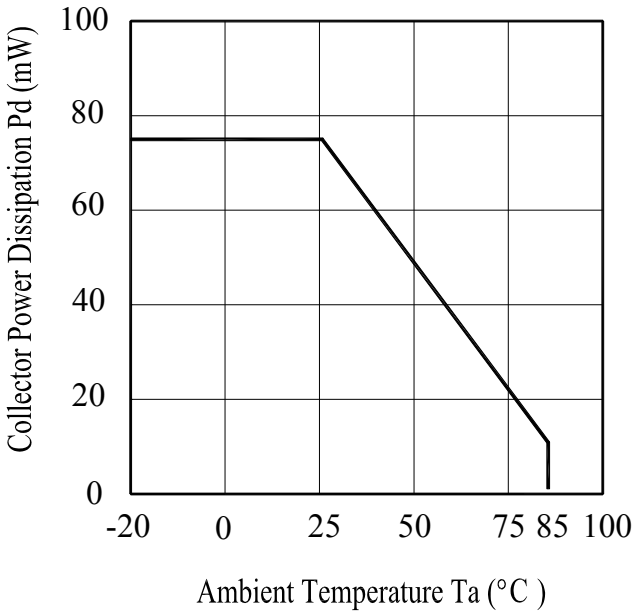

Fig.2 Spectral Distribution

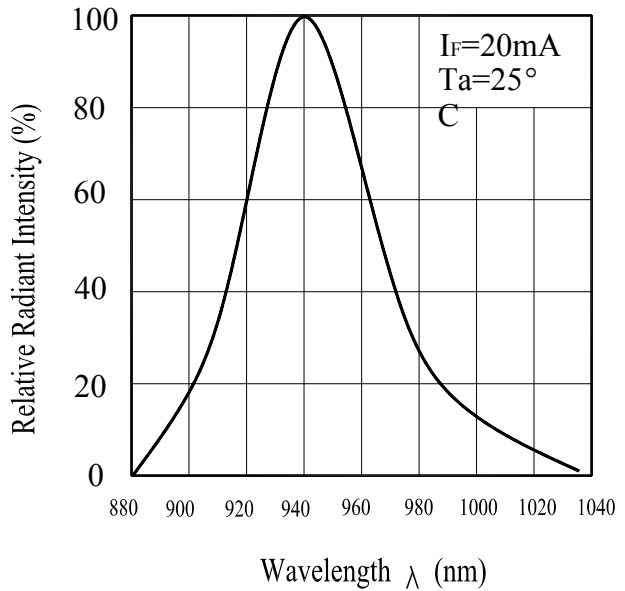

Fig.3 Peak Emission Wavelength vs. Ambient Temperature

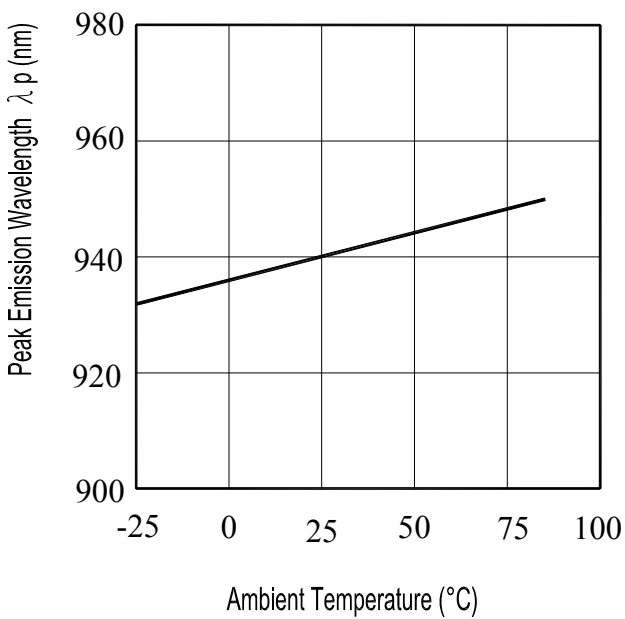

Fig.4 Forward Current vs. Forward Voltage

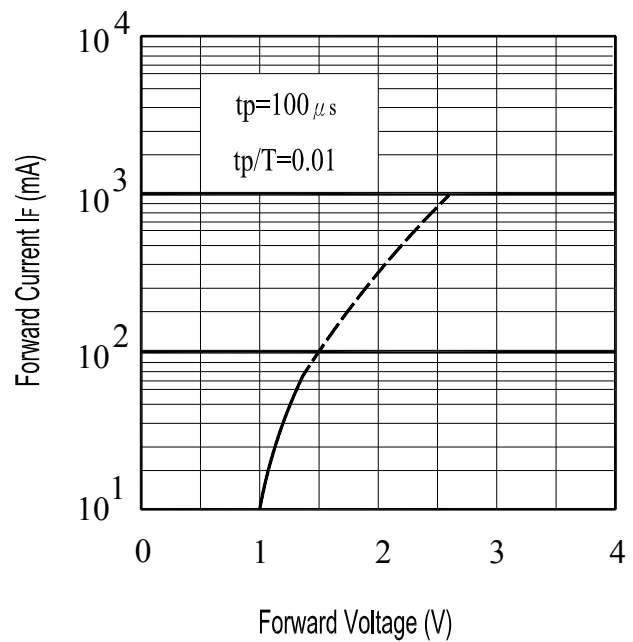

Fig.8 Forward Voltage vs. Ambient Temperature(°C)

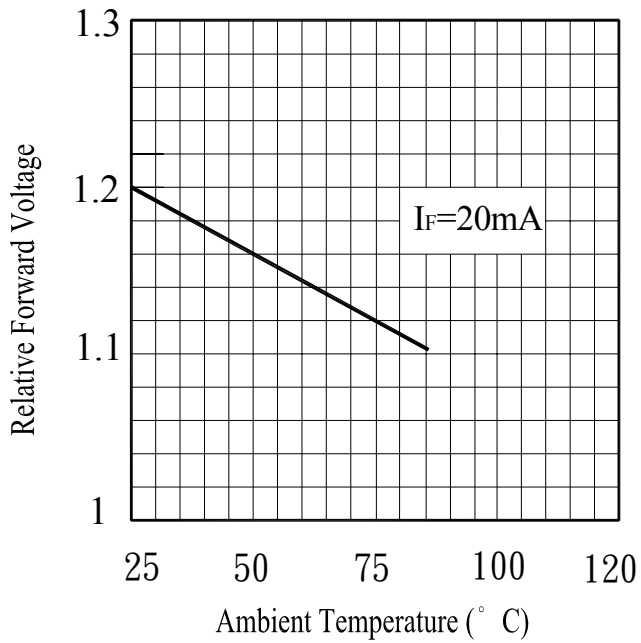
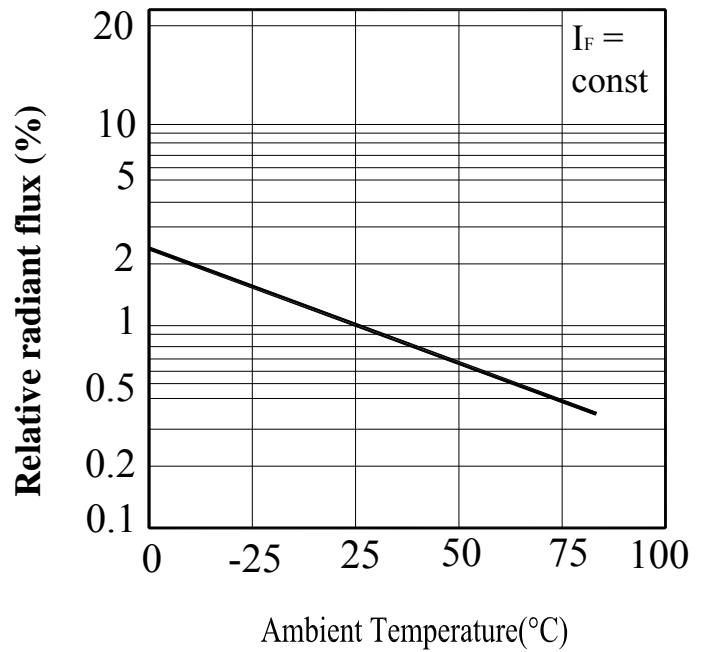

Fig.6 Relative Radiant Flux vs. Ambient Temperature(°C)



**Typical Electrical/Optical/Characteristics Curves for PT**

Fig.1 Collector Power Dissipation vs. Ambient Temperature

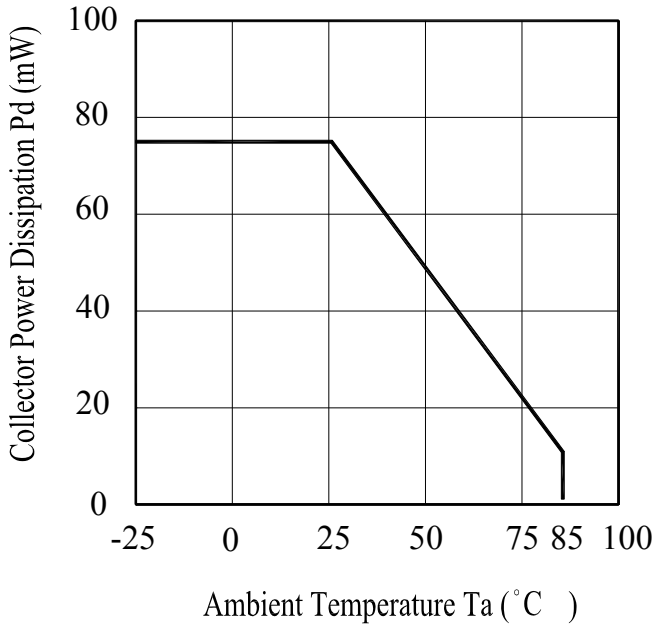

Fig.2 Spectral Sensitivity

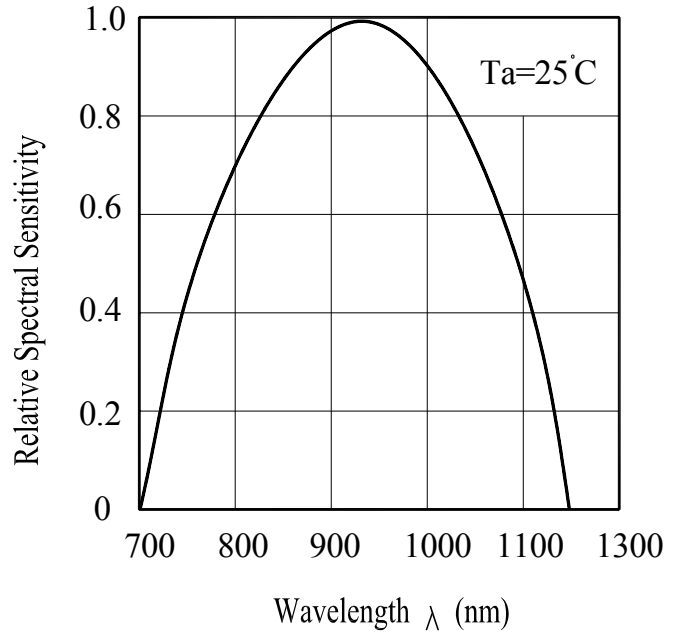

Fig.3 Relative Collector Current vs. Ambient Temperature

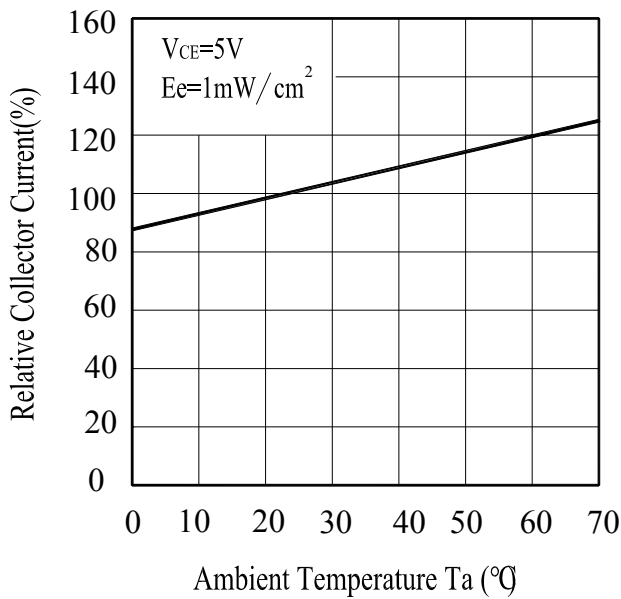
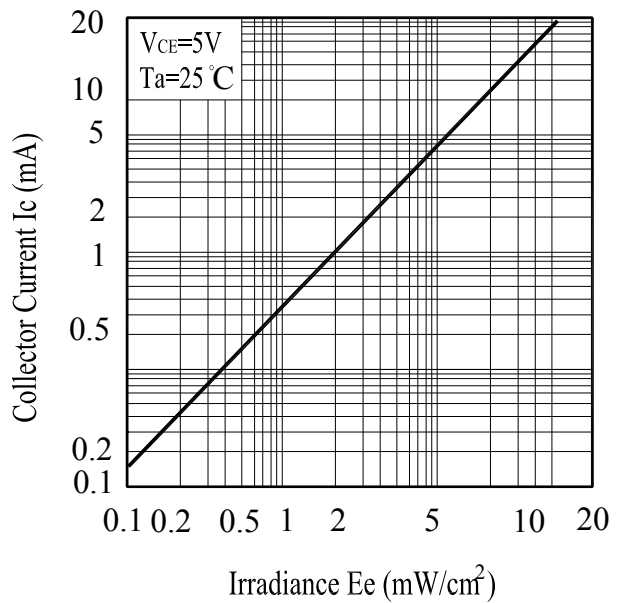

Fig.4 Collector Current vs. Irradiance



**Typical Electro-Optical Characteristics Curves**

Fig.5 Collector Dark Current vs. Ambient Temperature

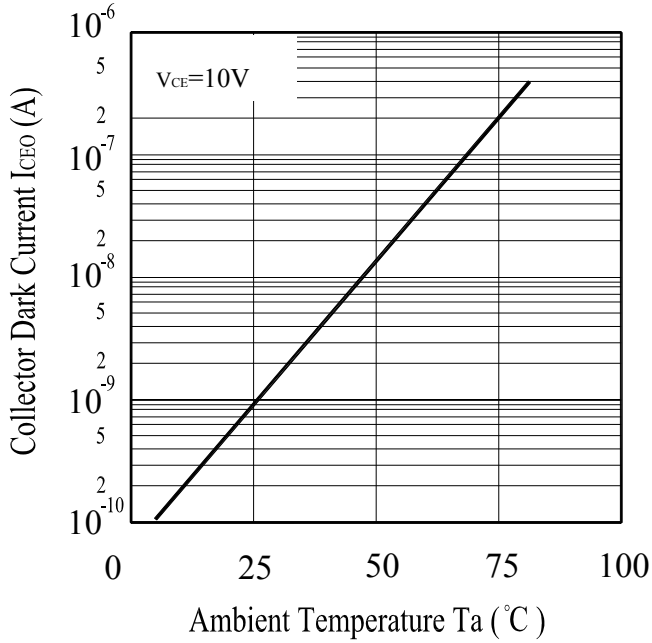
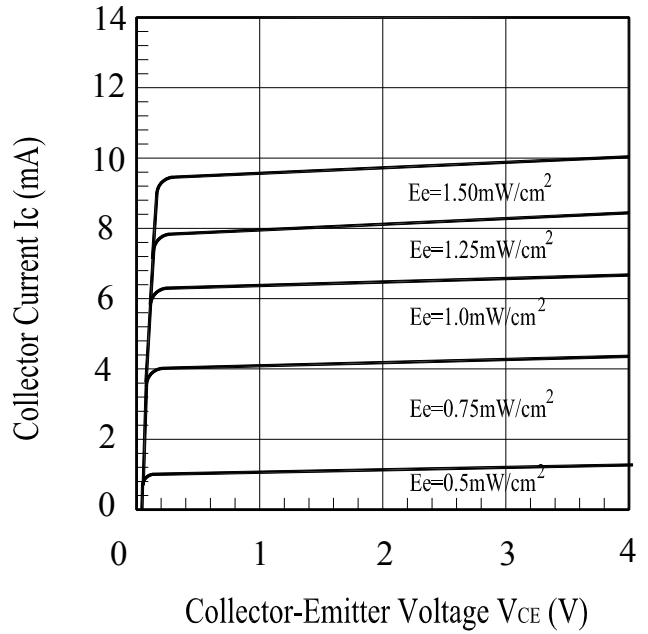

Fig.6 Collector Current vs. Collector-Emitter Voltage



**Reliability Test Item And Condition**

The reliability of products shall be satisfied with items listed below.

Confidence level : 90%

LTPD : 10%

NO.	Item	Test Conditions	Test Hours/ Cycles	Sample Sizes	Failure Judgement Criteria	Ac/Re
1	Solder Heat	TEMP. : 260°C±5°C	10secs	22pcs	I <sub>c(on)</sub> ≤ L×0.8  L :the initial test value	0/1
2	Temperature Cycle	H : 100°C     15mins ↑ 5mins ↓ L : -40°C     15mins	300Cycles	22pcs		0/1
3	Thermal Shock	H :+100°C     5mins ↑ 10secs ↓ L :-10°C     5mins	300Cycles	22pcs		0/1
4	High Temperature Storage	TEMP. : +100°C	1000hrs	22pcs		0/1
5	Low Temperature Storage	TEMP. : -40°C	1000hrs	22pcs		0/1
6	DC Operating Life	I <sub>F</sub> =20mA	1000hrs	22pcs		0/1
7	High Temperature/ High Humidity	85°C / 85% R.H	1000hrs	22pcs		0/1





**ITR20402**

## Label Form Specification



CPN: Customer's Production Number  
P/N : Production Number  
QTY: Packing Quantity  
CAT: Ranks  
HUE: Peak Wavelength  
REF: Reference  
LOT No: Lot Number

## Notes

1. Above specification may be changed without notice. EVERLIGHT will reserve authority on material change for above specification.
2. When using this product, please observe the absolute maximum ratings and the instructions for using outlined in these specification sheets. EVERLIGHT assumes no responsibility for any damage resulting from use of the product which does not comply with the absolute maximum ratings and the instructions included in these specification sheets.
3. These specification sheets include materials protected under copyright of EVERLIGHT corporation. Please don't reproduce or cause anyone to reproduce them without EVERLIGHT's consent.

**EVERLIGHT ELECTRONICS CO., LTD.**  
Office: No 25, Lane 76, Sec 3, Chung Yang Rd,  
Tucheng, Taipei 236, Taiwan, R.O.C

Tel: 886-2-2267-2000, 2267-9936  
Fax: 886-2267-6244, 2267-6189, 2267-6306  
<http://www.everlight.com>