

TOSHIBA LED LAMP

**TLRE1008A(T04), TLSE1008A(T04), TLOE1008A(T04), TLYE1008A(T04), TLPYE1008A(T04), TLGE1008A(T04), TLFGE1008A(T04), TLPGE1008A(T04)**

PANEL CIRCUIT INDICATOR

Unit in mm

- 1.6 × 0.8 × 0.6 mm (L × W × H)  
TL□E1008A (T04) Series
- InGaAlP LED
- It can be manufactured high-luminosity of equipment or reduce of electric power consumption by change in the high-luminosity LED from general-luminosity one.
- Colors : Red, Orange, Yellow, Pure Yellow, Green, Pure Green
- Since the products are only 0.6 mm thick, they are suitable for use in thin equipment.
- Can be mounted using surface mounter.
- Reflow soldering is possible.
- Standard embossed tapping  
4 mm pitch : T04 (4000 pcs / reel)
- Applications : As backlighting source for battery-powered equipment  
As pilot light for compact equipment  
In low-power electronic equipment, etc.

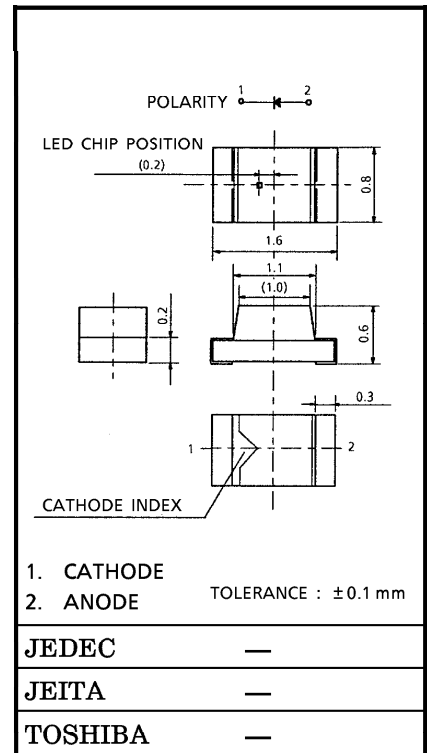

Weight : 0.0013 g

LINE-UP

PRODUCT NAME	COLOR	MATERIAL
TLRE1008A	Red	InGaAlP
TLSE1008A	Red	InGaAlP
TLOE1008A	Orange	InGaAlP
TLYE1008A	Yellow	InGaAlP
TLPYE1008A	Pure Yellow	InGaAlP
TLGE1008A	Green	InGaAlP
TLFGE1008A	Green	InGaAlP
TLPGE1008A	Pure-Green	InGaAlP

MAXIMUM RATINGS (Ta = 25°C)

PRODUCT NAME	FORWARD CURRENT I <sub>F</sub> (mA)	REVERSE VOLTAGE V <sub>R</sub> (V)	POWER DISSIPATION P <sub>D</sub> (mW)	OPERATION TEMPERATURE T <sub>opr</sub> (°C)	STORAGE TEMPERATURE T <sub>stg</sub> (°C)
TLRE1008A	25	4	60	-40~85	-40~100
TLSE1008A					
TLOE1008A					
TLYE1008A					
TLPYE1008A					
TLGE1008A					
TLFGE1008A					
TLPGE1008A					

ELECTRICAL CHARACTERISTICS (Ta = 25°C)

PRODUCT NAME	FORWARD VOLTAGE V <sub>F</sub>			REVERSE CURRENT I <sub>R</sub>	
	MIN	TYP.	MAX	I <sub>F</sub>	V <sub>R</sub>
TLRE1008A	—	1.9	2.4	20	50
TLSE1008A	—	1.9	2.4		
TLOE1008A	—	2.0	2.4		
TLYE1008A	—	2.0	2.4		
TLPYE1008A	—	2.0	2.4		
TLGE1008A	—	2.0	2.4		
TLFGE1008A	—	2.0	2.4		
TLPGE1008A	—	2.1	2.4		
UNIT	V			mA	μA

OPTICAL CHARACTERISTICS (Ta = 25°C)

PRODUCT NAME	LUMINOUS INTENSITY I <sub>v</sub>				EMISSION SPECTRUM							
	MIN	TYP.	MAX	I <sub>F</sub>	Peak Emission Wavelength λ <sub>p</sub>			Δλ	Dominant Wavelength λ <sub>d</sub>			I <sub>F</sub>
					MIN	TYP.	MAX	TYP.	MIN	TYP.	MAX	
TLRE1008A	27.2	70	—	20	—	644	—	18	—	630	—	20
TLSE1008A	47.6	140	—		—	623	—	17	—	613	—	
TLOE1008A	47.6	180	—		—	612	—	15	—	605	—	
TLYE1008A	27.2	105	—		—	590	—	13	—	587	—	
TLPYE1008A	27.2	70	—		—	583	—	13	—	580	—	
TLGE1008A	27.2	70	—		—	574	—	11	—	571	—	
TLFGE1008A	15.3	40	—		—	568	—	11	—	565	—	
TLPGE1008A	4.76	18	—		—	562	—	11	—	558	—	
UNIT	mcd			mA	nm			nm	nm			mA

(Note) : This visible LED lamp also emits some IR light.  
 If a photodetector is located near the LED lamp, please ensure that it will not be affected by this IR light.

TLRE1008A

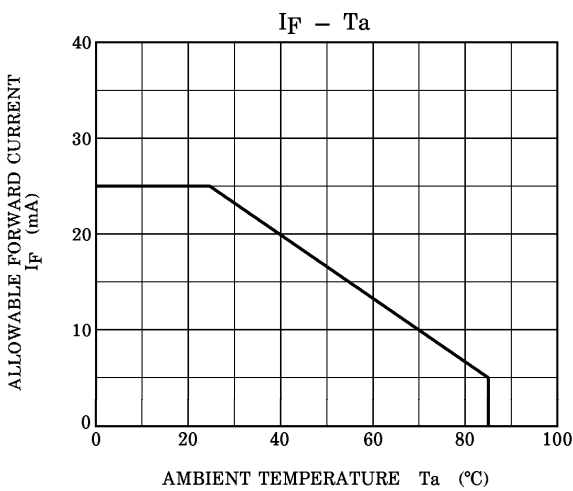
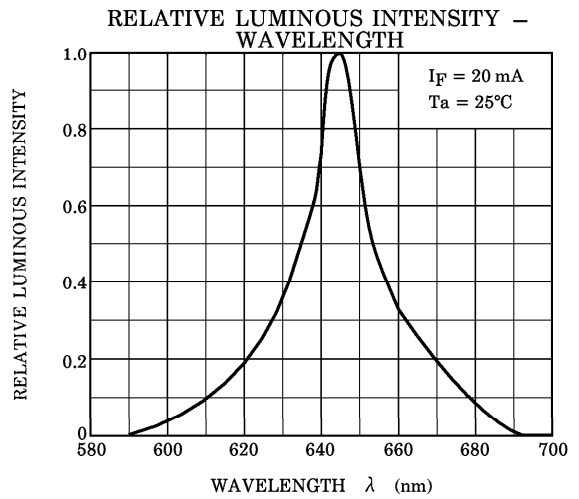
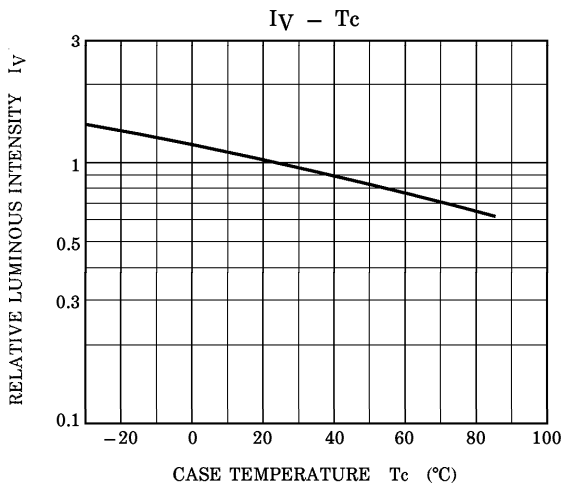
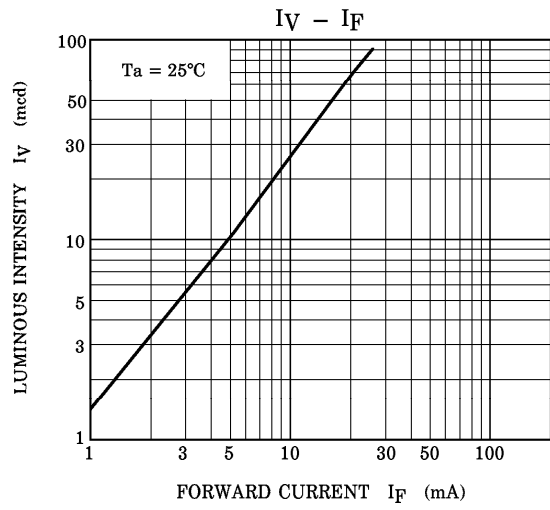
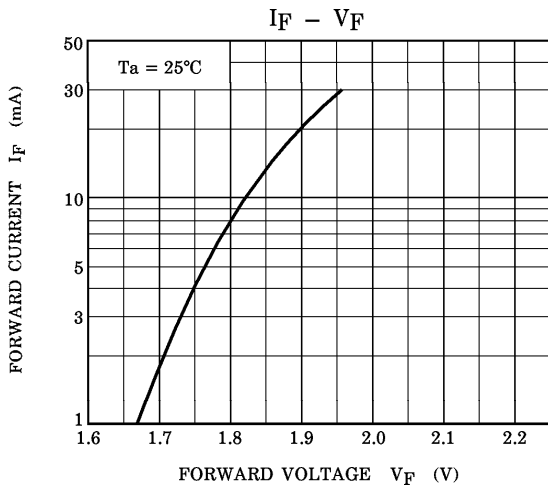

TLSE1008A

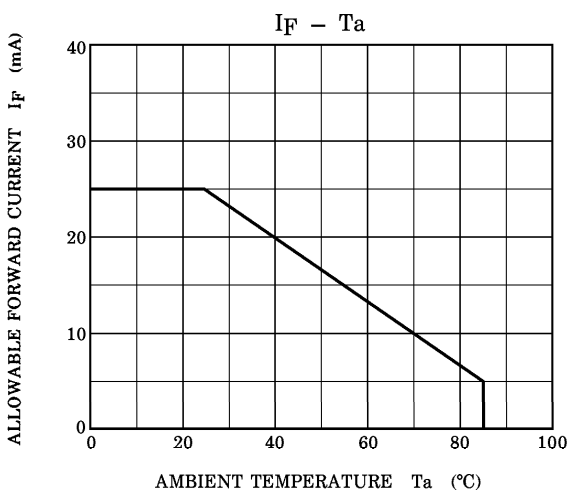
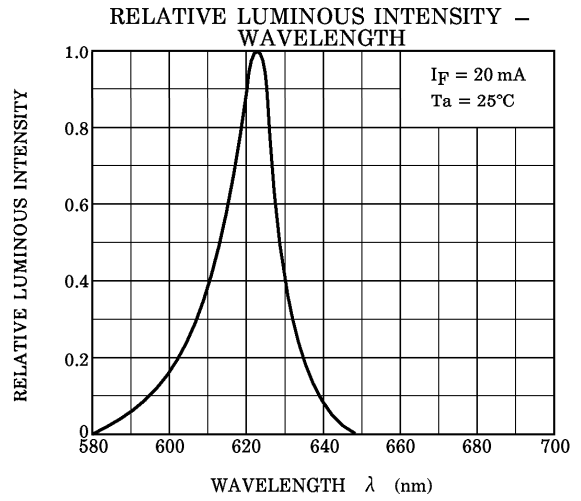
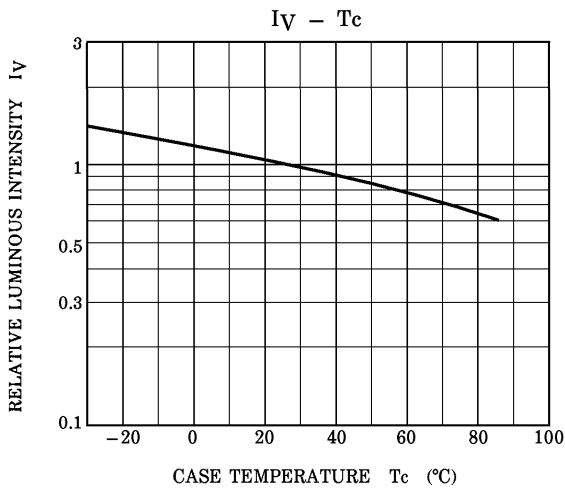
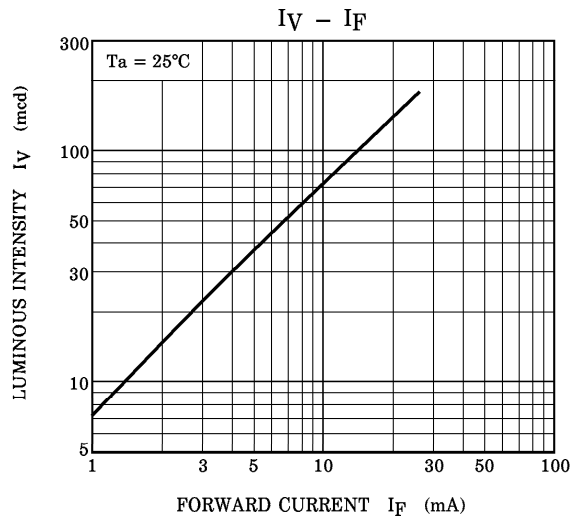
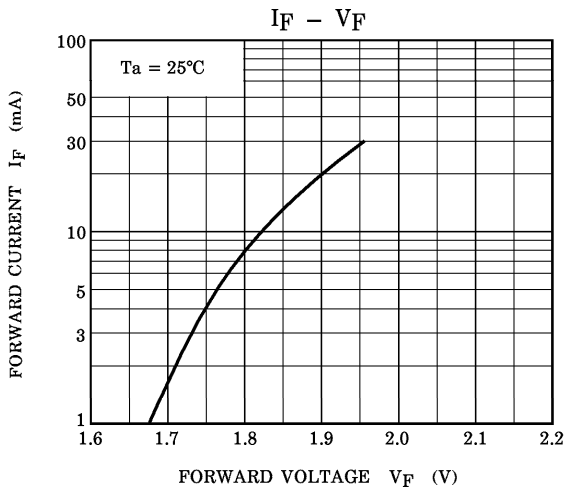

TLOE1008A

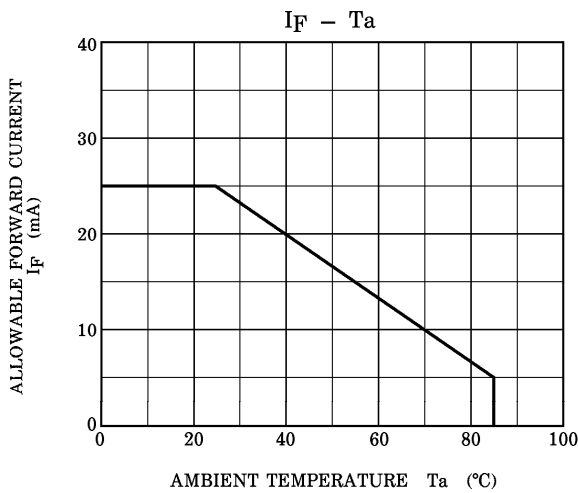
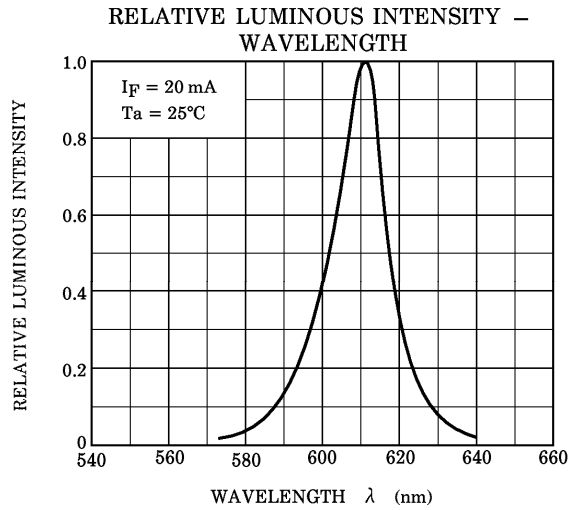
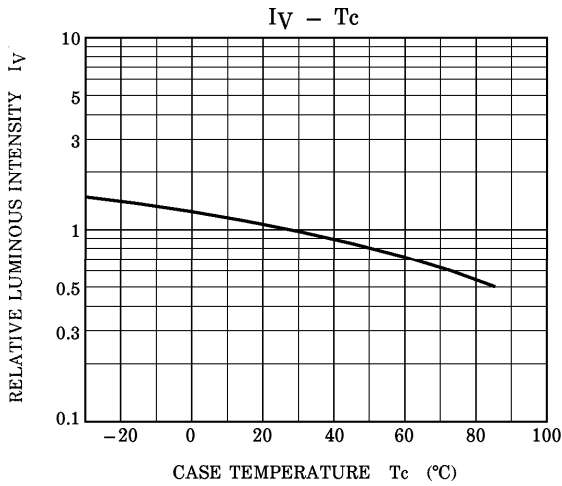
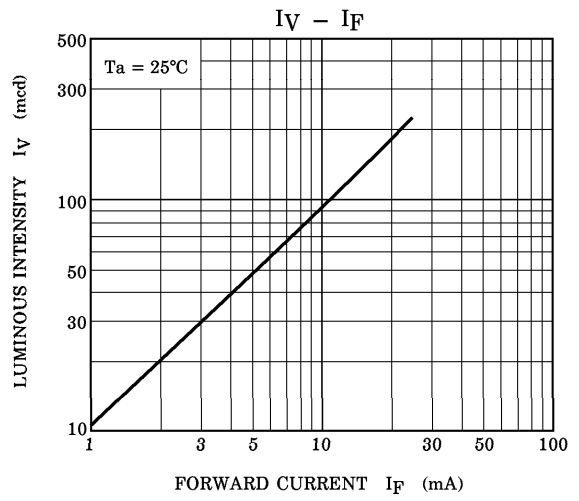
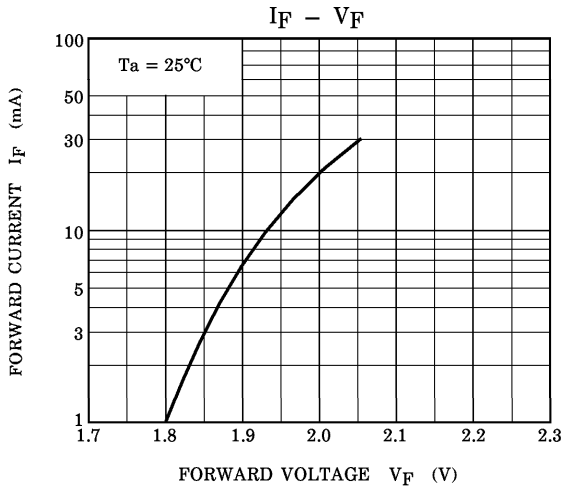

TLYE1008A

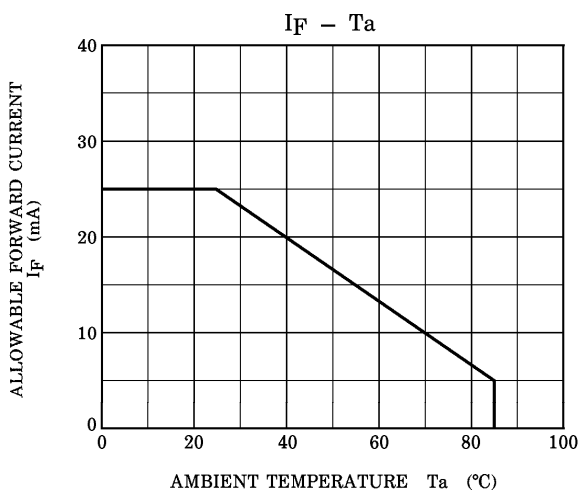
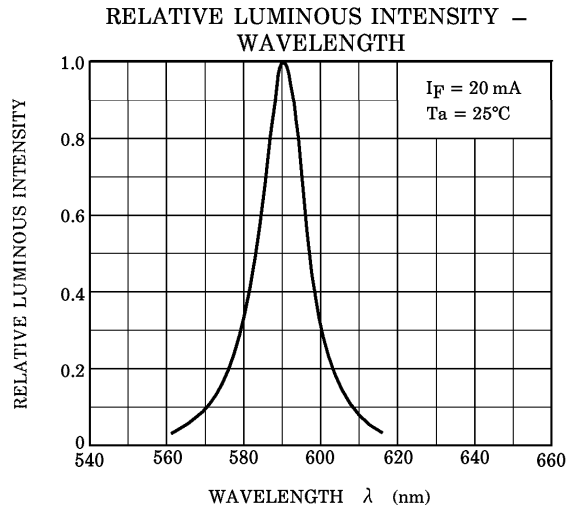
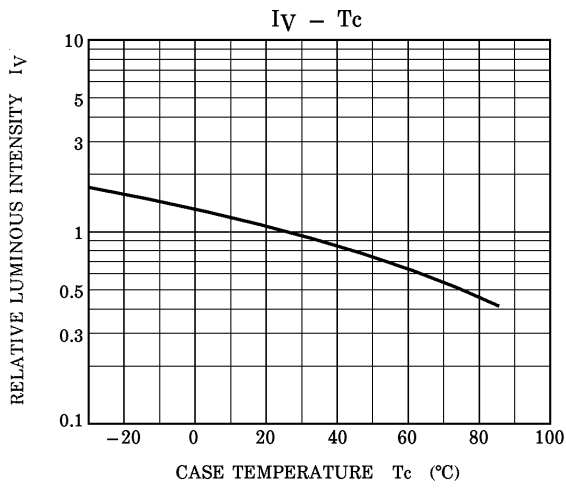
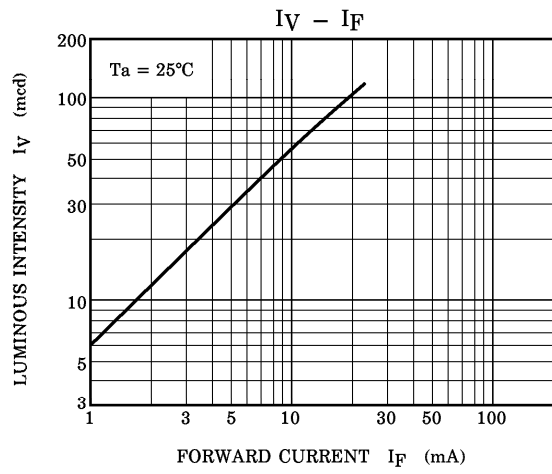
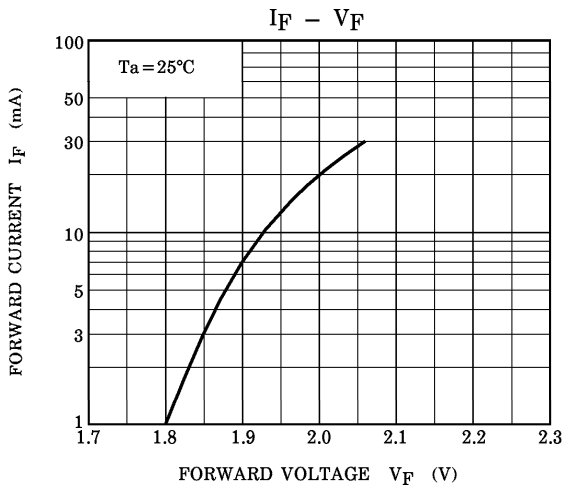

TLPYE1008A

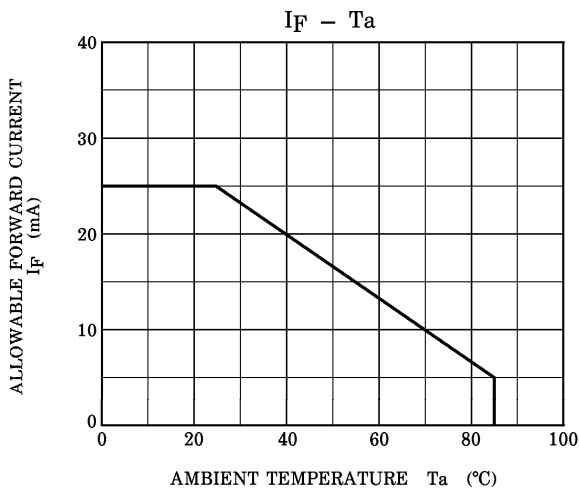
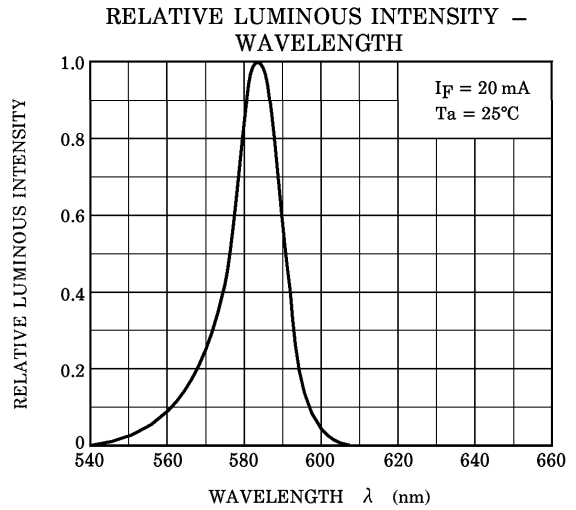
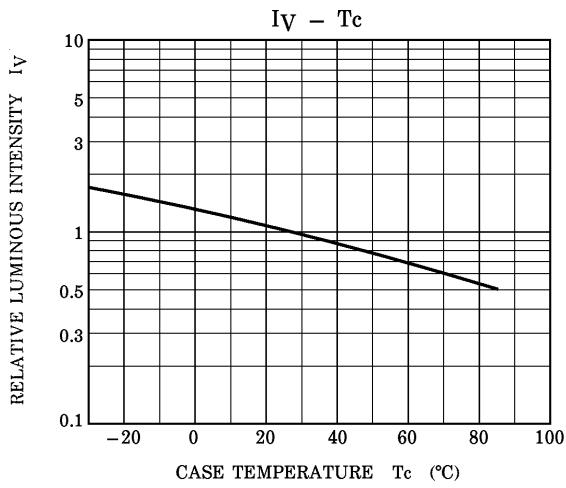
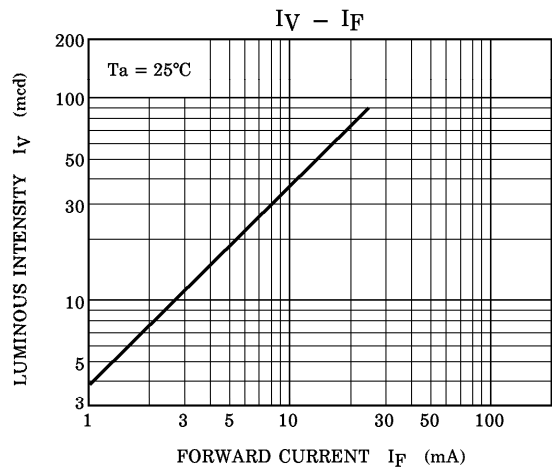
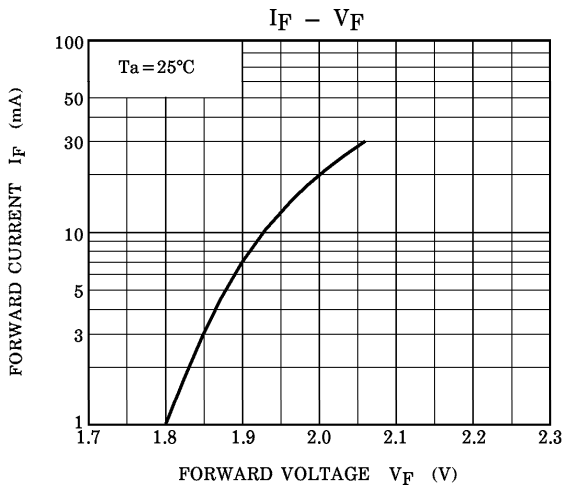

TLGE1008A

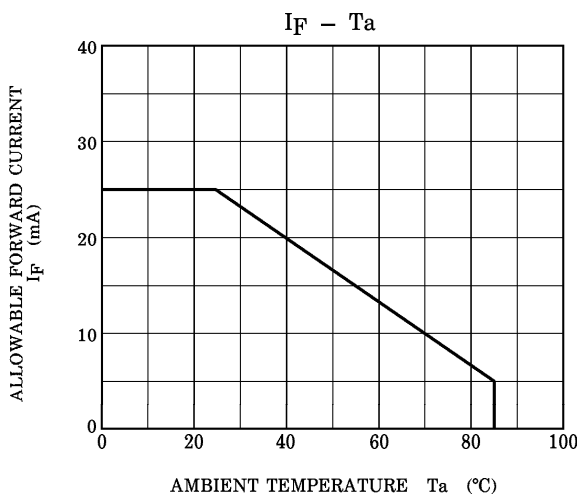
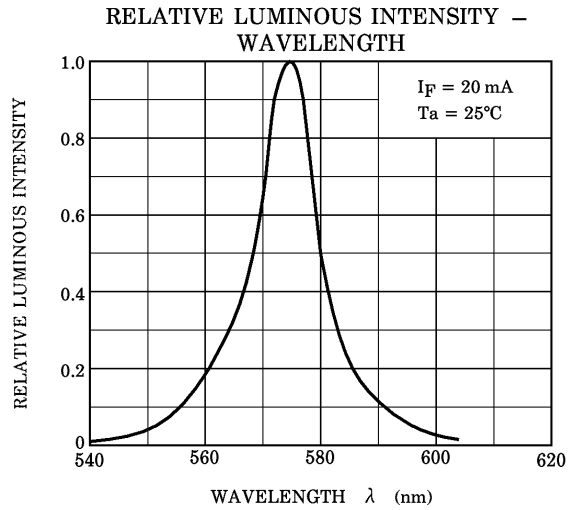
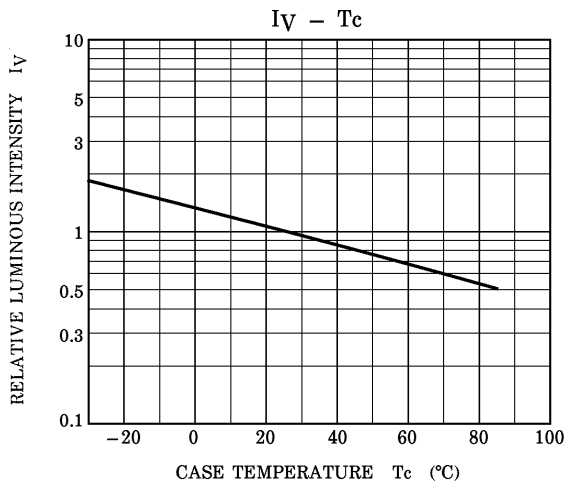
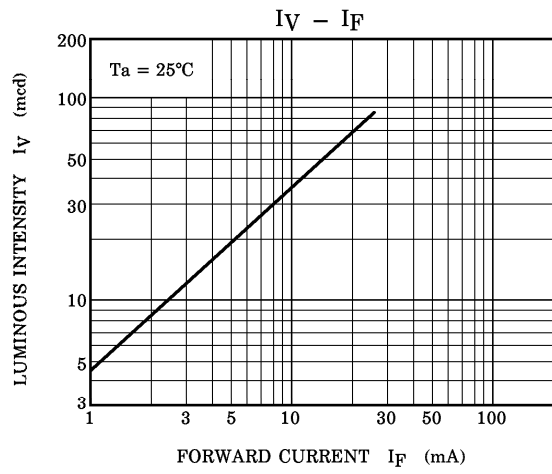
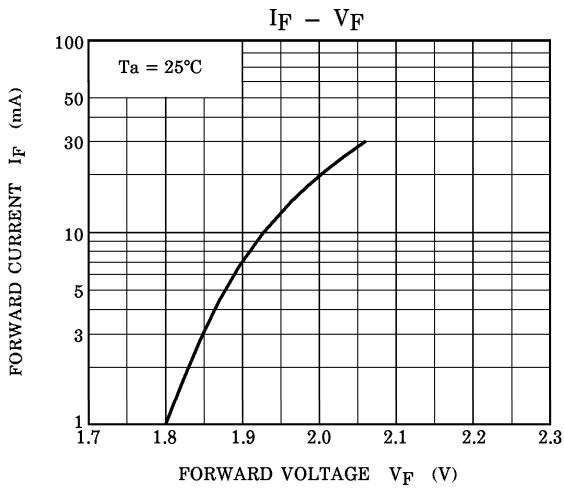



TLFGE1008A

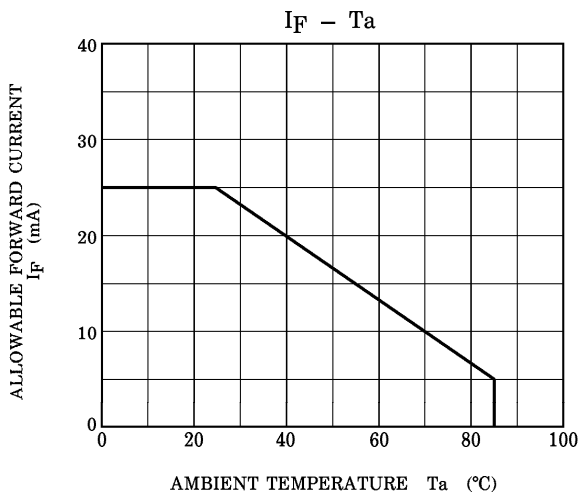
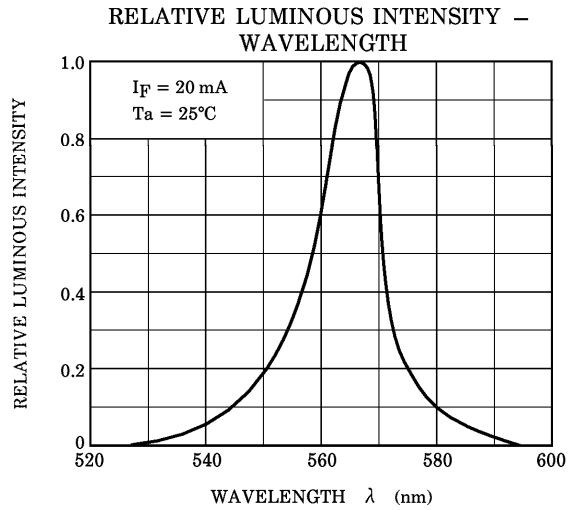
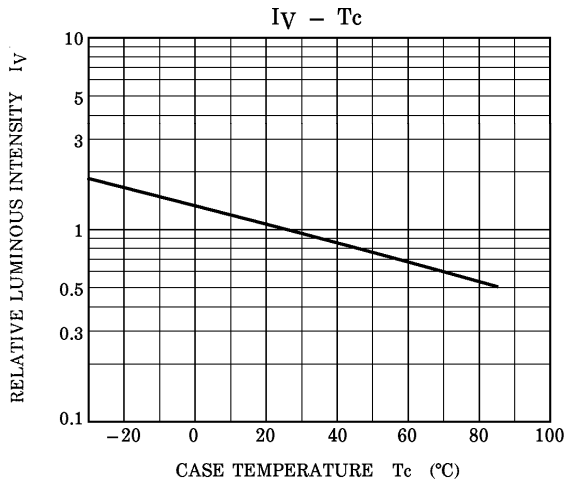
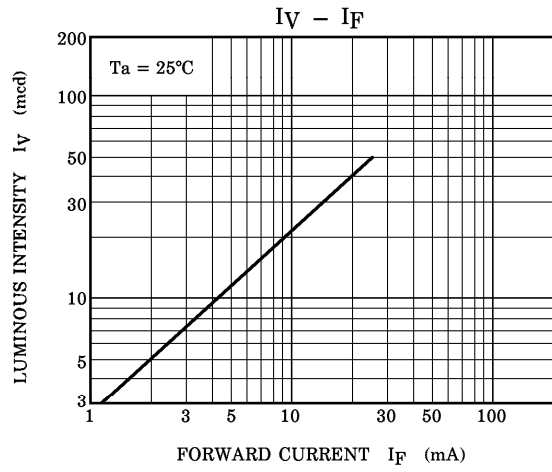
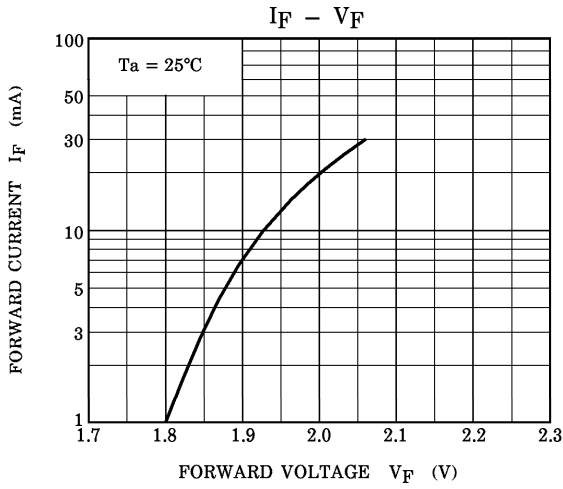

TLPGE1008A

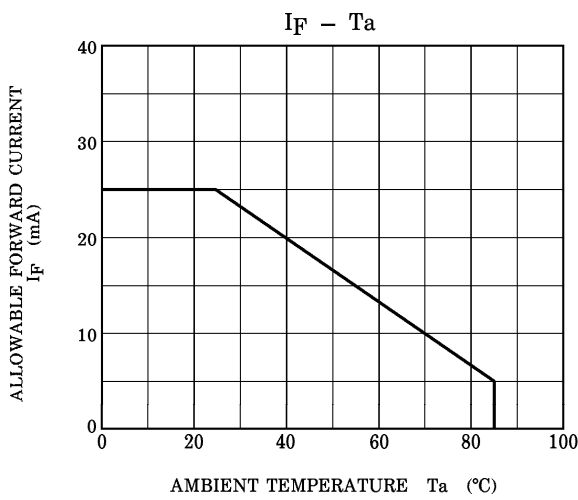
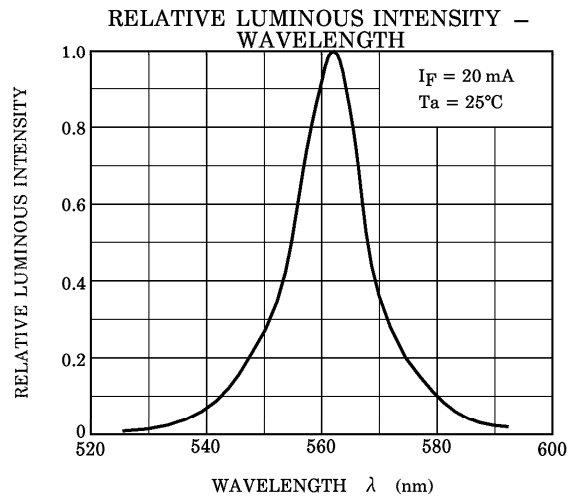
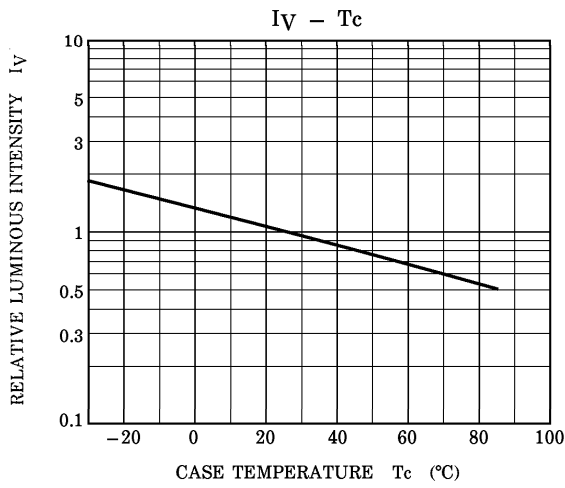
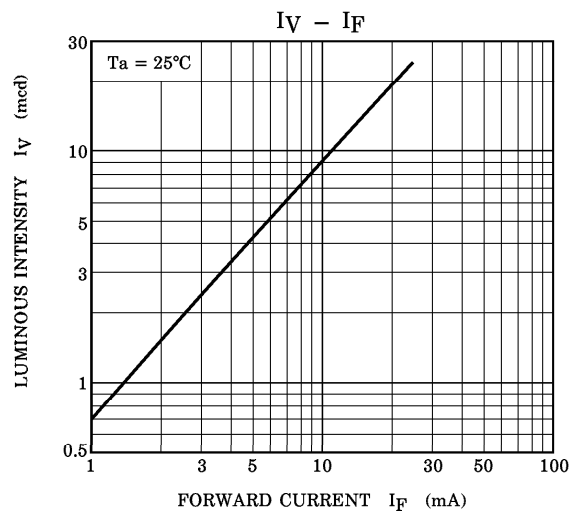
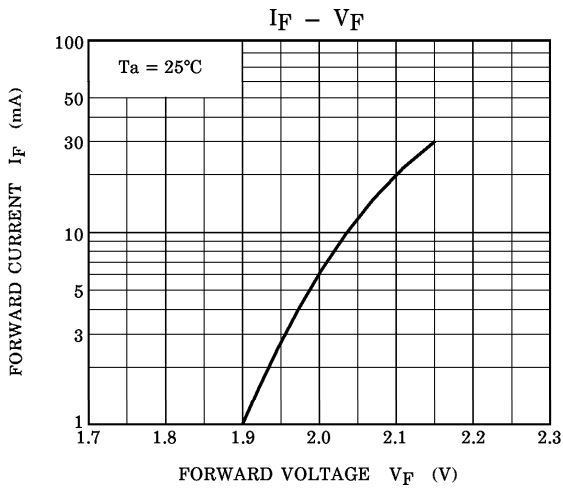

TL□E1008A SERIES  
[RADIATION PATTERN]

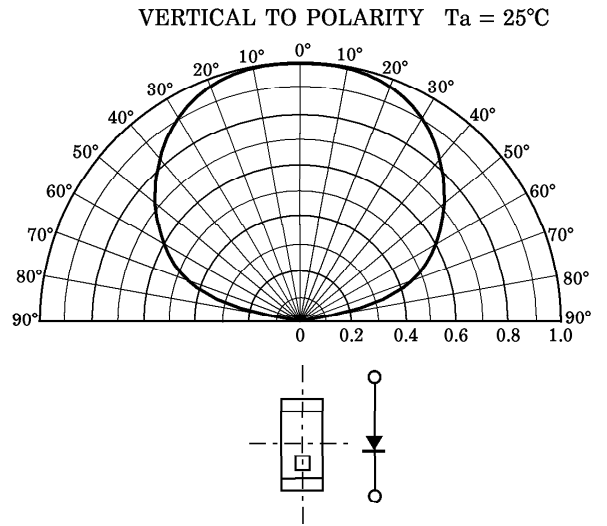
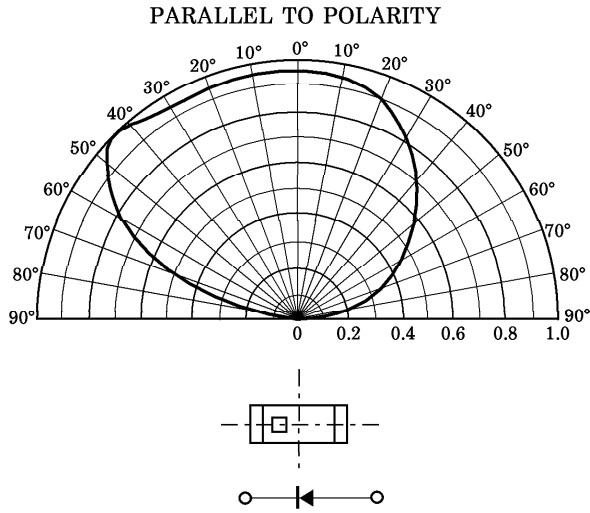

## PACKAGING

These LED devices are packed in an aluminum envelope with a silica gel and a moisture indicator to avoid moisture absorption. The optical characteristics of the devices may be affected by exposure to moisture in the air before soldering and they should therefore be stored under the following conditions :

1. This moisture proof bag may be stored unopened within 6 months at the following conditions.

Temperature : 5~30°C

Humidity : 90% (max)

2. After opening the moisture proof bag, the devices should be assembled within 168 hours in an environment of 5°C to 30°C / 60% RH or below.

3. If upon opening, the moisture indicator card shows humidity 30% or above (Color of indication changes to pink) or the expiration date has passed, the devices should be baked in taping with reel.

After baking, use the baked devices within 72 hours, but perform baking only once.

Baking conditions : 60 ± 5°C, for 12 to 24 hours.

Expiration date : 6 months from sealing date, which is imprinted on the same side as this label affixed.

4. Repeated baking can cause the peeling strength of the taping to change, then leads to trouble in mounting. Furthermore, prevent the devices from being destructed against static electricity for baking of it.

5. If the packing material of laminate would be broken, the airtightness would deteriorate.

Therefore, do not throw or drop the packed devices.

## MOUNTING METHOD

## SOLDERING

- Reflow soldering

Temperature profile

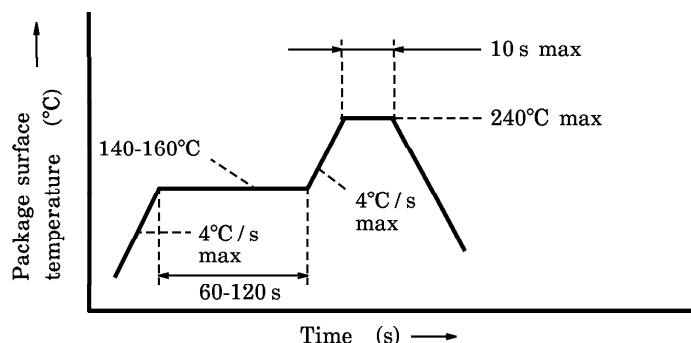

- Please perform the first reflow soldering within 168 h after opening the package with reference to the above temperature profile.

- Second time reflow soldering

In case of second reflow soldering, it should be performed within 168 h after first reflow under the above conditions.

Storage conditions before second reflow soldering : 30°C, 60% RH or lower

- Do not perform flow soldering.
- Make any necessary soldering corrections manually.  
(Do not do this more than once for any given pin.)

Soldering iron : 25 W

Temperature : no more than 300°C

Time : within 3 s

- Recommended soldering pattern

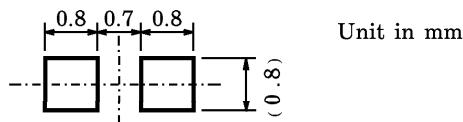

**POST SOLDER CLEANING**

When cleaning after soldering is needed, the following condition must be adhered to.

Cleaning solvents : AK225 or Alcohol

Temperature : 50°C (max) for 30 s (max) or 30°C (max) for 3 minutes (max)

Ultrasonic : 300 W max

**PRECAUTION FOR MOUNTING**

Do not apply force to the plastic part of the LED in high temperature conditions.

Do not apply friction using a hard materials for avoid injuring the plastic part of the LED.

Keep the LED away from any other parts when assembling boards into the set.

**TAPING SPECIFICATIONS**

This specification lays out the 4 mm pitch embossed-tape packing requirements for 1.6 mm (L) × 0.8 mm (W) × 0.6 mm (H) size surface-mount LED lamp.

**1. Product Naming System**

The type of package used for shipment is denoted by a symbol suffix after the product number. The method of classification is as below. (this method, however does not apply to products whose electrical characteristics differ from standard Toshiba specifications)

(1) Tape Type : T04 (4 mm pitch)

(2) Example

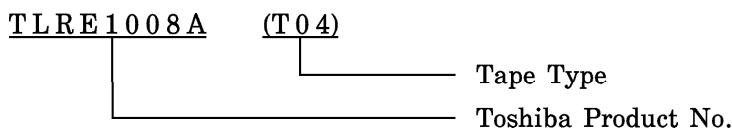

2. Related Matter

(1) Electro-optical Characteristics

Please refer to the each technical datasheet for electro-optical characteristics of tape packed products

(2) Handling Precautions

Tape material protected against static electricity. However, static electricity may occur depending on quantity of charged static electricity and a device may attach to a tape, or a device may be unstable when peeling a tape cover.

- a) In process, taping materials may sustain an electrostatic charge, use an ionizer to neutralize the ions.
- b) For transport and temporary storage of devices, use containers (boxes, jigs, bags) that are made of anti-static materials or of materials that dissipate electrostatic electricity.

3. Tape Dimensions

(Unit in mm)

SYMBOL	DIMENSION	TOLERANCE	SYMBOL	DIMENSION	TOLERANCE
D	1.50	+0.1 / -0	P <sub>2</sub>	2.00	±0.05
E	1.75	±0.1	W	8.00	±0.1
P <sub>0</sub>	4.00	±0.1	P	4.00	±0.1
t	0.20	±0.05	A <sub>0</sub>	0.90	±0.1
F	3.50	±0.05	B <sub>0</sub>	1.75	±0.1
D <sub>1</sub>	0.60	±0.05	K <sub>0</sub>	0.75	±0.1

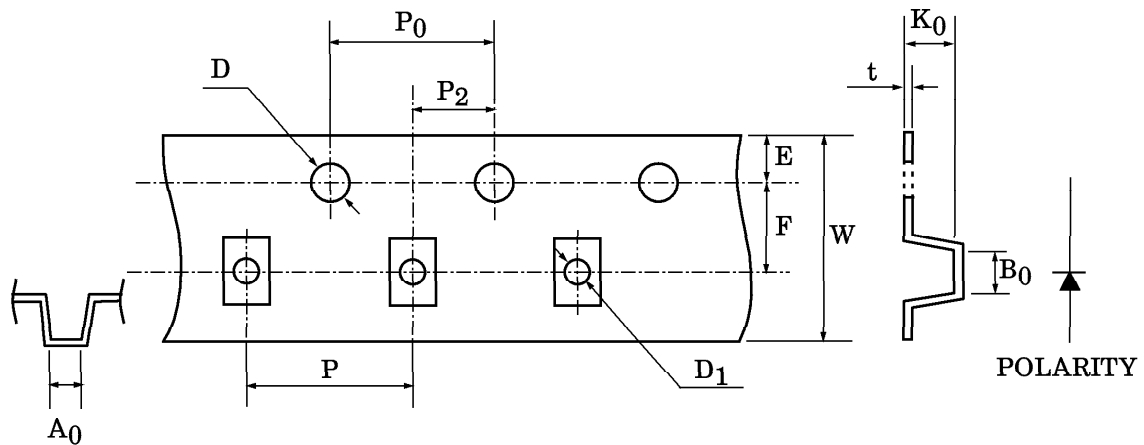

4. Reel Dimensions

Unit in mm

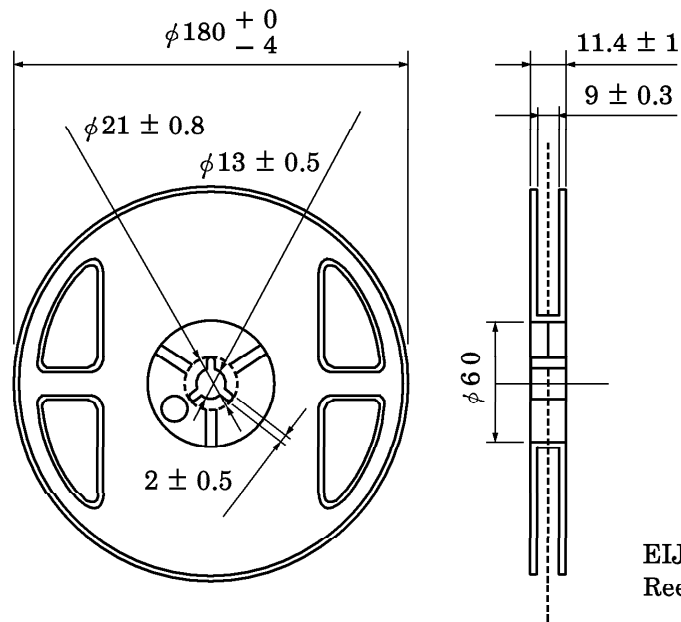

EIJA standard : RRM08B  
 Reel Material : polystyrene

5. Leader and Trailer

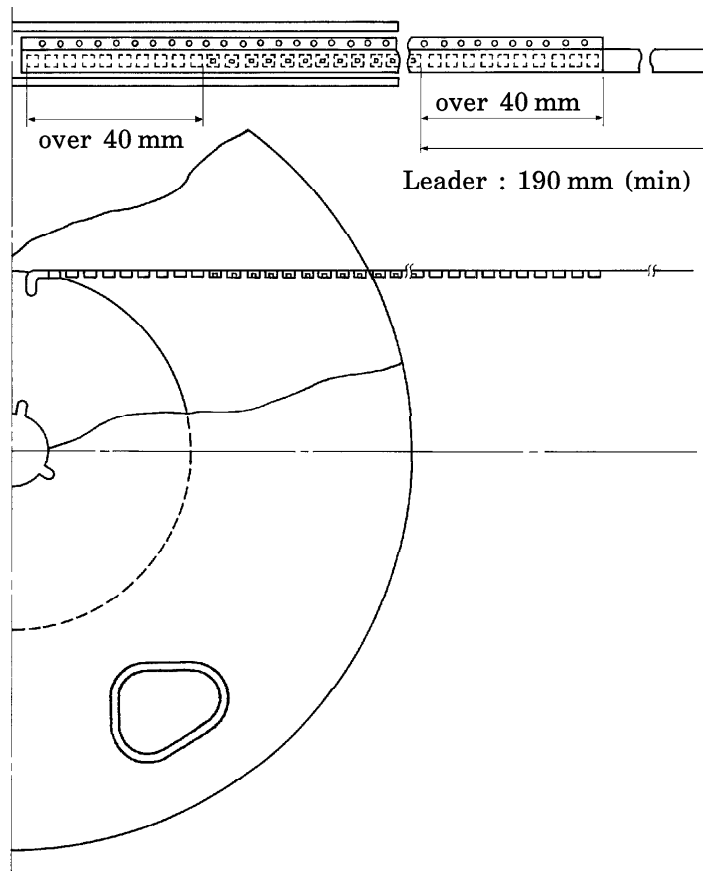

6. Packing Form

(1) Number of Devices per Reel and Carton

Reel	4000 devices
Carton	20000 devices

(2) Packing : Silica gel and reel are packed into sealed aluminum pack.

7. Notation Method

(1) Example : TLRE1008A (T04)

P/N :

TYPE	TLRE1008A		
ADD. C	(T04)	Q'TY	4000 pcs
NOTE (rank symbol)	Lot Number		

(2) Label location :

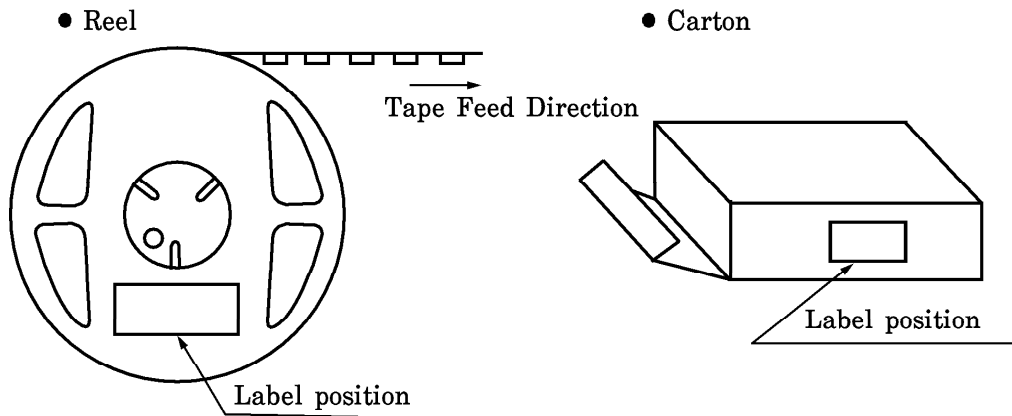

● Aluminum pack : Attached to center of one side



**RESTRICTIONS ON PRODUCT USE**

000707EAC

- TOSHIBA is continually working to improve the quality and reliability of its products. Nevertheless, semiconductor devices in general can malfunction or fail due to their inherent electrical sensitivity and vulnerability to physical stress. It is the responsibility of the buyer, when utilizing TOSHIBA products, to comply with the standards of safety in making a safe design for the entire system, and to avoid situations in which a malfunction or failure of such TOSHIBA products could cause loss of human life, bodily injury or damage to property. In developing your designs, please ensure that TOSHIBA products are used within specified operating ranges as set forth in the most recent TOSHIBA products specifications. Also, please keep in mind the precautions and conditions set forth in the "Handling Guide for Semiconductor Devices," or "TOSHIBA Semiconductor Reliability Handbook" etc..
- The TOSHIBA products listed in this document are intended for usage in general electronics applications (computer, personal equipment, office equipment, measuring equipment, industrial robotics, domestic appliances, etc.). These TOSHIBA products are neither intended nor warranted for usage in equipment that requires extraordinarily high quality and/or reliability or a malfunction or failure of which may cause loss of human life or bodily injury ("Unintended Usage"). Unintended Usage include atomic energy control instruments, airplane or spaceship instruments, transportation instruments, traffic signal instruments, combustion control instruments, medical instruments, all types of safety devices, etc.. Unintended Usage of TOSHIBA products listed in this document shall be made at the customer's own risk.
- Gallium arsenide (GaAs) is a substance used in the products described in this document. GaAs dust and fumes are toxic. Do not break, cut or pulverize the product, or use chemicals to dissolve them. When disposing of the products, follow the appropriate regulations. Do not dispose of the products with other industrial waste or with domestic garbage.
- The information contained herein is presented only as a guide for the applications of our products. No responsibility is assumed by TOSHIBA CORPORATION for any infringements of intellectual property or other rights of the third parties which may result from its use. No license is granted by implication or otherwise under any intellectual property or other rights of TOSHIBA CORPORATION or others.
- The information contained herein is subject to change without notice.