

SKY65225-11: WLAN 802.11n 2 x 2 MIMO Intera™ Front-End Module

Features

- Two full dual-band transmit/receive chains
- PCIe, miniPCI, Cardbus, and access point applications
- Backward-compatible with 802.11a/b/g standards
- P_{OUT} @ 2.5% EVM: 16 dBm (-11a); 19 dBm (-11b); 19 dBm (-11g)
- Gain matching: <math><1.0\text{ dB}</math> @ 2 GHz, 2.0 dB @ 5 GHz
- Single 3.0–3.6 V power supply, internal voltage regulation
- Temperature-compensated PA bias networks and directional power detection
- Separate digital controls for each PA
- Package size: 10 x 14 x 0.9 mm
- Lead (Pb)-free and RoHS-compliant MSL-3 @ 250 °C per JEDEC J-STD-020

NEW Skyworks offers lead (Pb)-free, RoHS (Restriction of Hazardous Substances)-compliant packaging.



Description

The SKY65225-11 Intera nFEM combines two complete dual-band transmit/receive chains in one compact RF front end module optimized for 2 x 2 MIMO (multiple in – multiple out) operation, in compliance with the 802.11n draft standard. The SKY65225-11 includes two 5 GHz PAs and two 2 GHz PAs, each with integrated input filtering for 3–4 GHz rejection, and two temperature-compensated, directional power detectors with 20 dB dynamic range. Also included are low loss, high rejection GaAs diplexers and switches which provide high linearity in all transmit paths and low loss in all receive paths. All RF ports are matched to 50 Ω .

The SKY65225-11 Intera nFEM achieves outstanding gain matching between both 2 GHz transmit paths and both 5 GHz transmit paths, which is a critical requirement for MIMO operation. This is accomplished through mirrored layout symmetry.

The SKY65225-11 is packaged in a lead (Pb)-free, RoHS-compliant laminate package, which measures 140 mm². This tiny footprint enables more functionality in less PCB space.

Functional Block Diagram

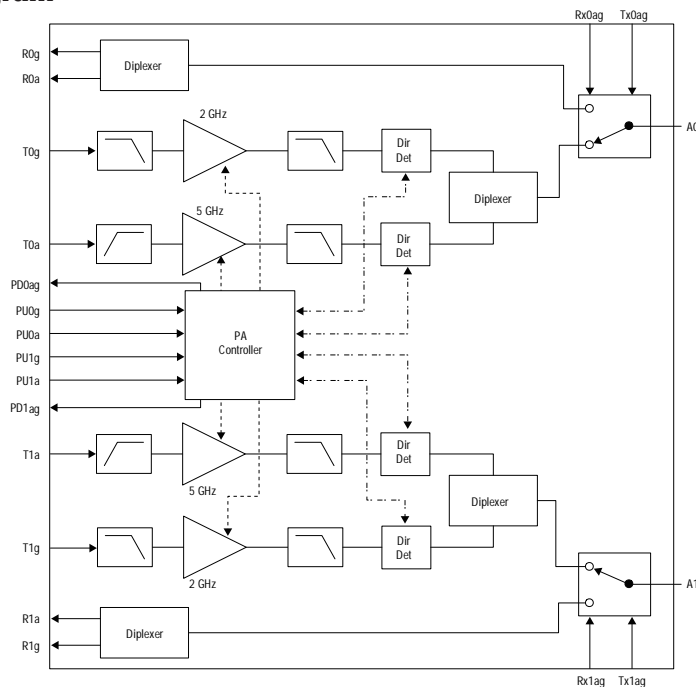

Innovation to Go™
Now available for purchase online.

Absolute Maximum Ratings

Parameter	Symbol	Condition	Min.	Typ.	Max.	Unit
V _{CC}	V _{CC}		-0.3		5.5	V
PU0g, PU1g, PU0a, PU1a	PU		-0.3		5.5	V
T0g, T1g, T0a, T1a	RFin				10	dBm
Operating temperature range	T _{OP}		0		85	°C
Storage temperature range	T _{STO}		-65		125	°C
Moisture sensitivity level	MSL-3				250	°C
Thermal resistance	θ _{JC}				60	°C/W

Performance is guaranteed only under the conditions listed in the specifications table and is not guaranteed under the full range(s) described by the Absolute Maximum specifications. Exceeding any of the absolute maximum/minimum specifications may result in permanent damage to the device and will void the warranty.

Recommended Operating Conditions

Parameter	Symbol	Condition	Min.	Typ.	Max.	Unit
Supply Voltage	V _{CC}		3	3.3	3.6	V
Operating Temperature	T _{OP}		0	25	85	°C

DC Characteristics

Conditions: V_{CC} = 3.3 V, T_{OP} = 25 °C. Measurements made on Skyworks EVB with all losses de-embedded. All unused ports terminated into 50 Ω unless otherwise specified.

Parameter	Symbol	Condition	Min.	Typ.	Max.	Unit
Total 802.11g Tx supply current, T0g or T1g	I _{CC-g}	P _{OUT} = 18 dBm, 54 Mbps OFDM, PU0g or PU1g = 3.3 V PU0a or PU1a = 0 V		190		mA
Total 802.11g Tx quiescent current, T0g or T1g	I _{CQ-g}	No RF		95		mA
Total 802.11b Tx supply current, T0g or T1g	I _{CC-b}	P _{OUT} = 18 dBm, 11 Mbps CCK PU0g or PU1g = 3.3 V PU0a or PU1a = 0 V		190		mA
Total 802.11a Tx supply current, T0a or T1a	I _{CC-a}	P _{OUT} = 15 dBm, 54 Mbps OFDM, PU0g or PU1g = 0 V PU0a or PU1a = 3.3 V		180		mA
Total 802.11a Tx quiescent current, T0g or T1g	I _{CQ-a}	No RF		135		mA

PA Logic Characteristics

Conditions: V_{CC} = 3.3 V, T_{OP} = 25 °C. Measurements made on Skyworks EVB with all losses de-embedded. All unused ports terminated into 50 Ω unless otherwise specified.

Parameter	Symbol	Condition	Min.	Typ.	Max.	Unit
Logic high voltage for PU0g, PU1g, PU0a, PU1a (Tx On)			2		V _{CC}	V
Logic low voltage for PU0g, PU1g, PU0a, PU1a (Tx Off)			0		0.5	V
Input current logic high voltage for PU0g, PU1g, PU0a, PU1a				100	200	µA
Input current logic low voltage for PU0g, PU1g, PU0a, PU1a				0.2		µA

Switch Characteristics

Conditions: $V_{CC} = 3.3\text{ V}$, $T_{OP} = 25\text{ }^{\circ}\text{C}$. Measurements made on Skyworks EVB with all losses de-embedded.
All unused ports terminated into $50\ \Omega$ unless otherwise specified.

Parameter	Symbol	Condition	Min.	Typ.	Max.	Unit
Control voltage - ON state	V_{CTL_on}		3	3.3	3.6	V
Control voltage - OFF state	V_{CTL_off}		0		0.2	V
Control current - ON state	I_{CTL_on}	RF ON		10	75	μA
Control current - ON state	I_{CTL_on}	RF OFF		2	20	μA

Mode Control Voltage Table (V)

Mode	V_{CC}	PU0g	PU0a	Rx0ag	Tx0ag	PU1g	PU1a	Rx1ag	Tx1ag
Sleep	3.3	0	0	0	0	0	0	0	0
T0g-A0	3.3	3.3	0	0	3.3	0	0	0	0
T0a-A0	3.3	0	3.3	0	3.3	0	0	0	0
R0g-A0	3.3	0	0	3.3	0	0	0	0	0
R0a-A0	3.3	0	0	3.3	0	0	0	0	0
T1g-A1	3.3	0	0	0	0	3.3	0	0	3.3
T1a-A1	3.3	0	0	0	0	0	3.3	0	3.3
R1g-A1	3.3	0	0	0	0	0	0	3.3	0
R1a-A1	3.3	0	0	0	0	0	0	3.3	0
802.11n Operation									
T0a-A0 & T1a-A1	3.3	0	3.3	0	3.3	0	3.3	0	3.3
T0g-A0 & T1g-A1	3.3	3.3	0	0	3.3	3.3	0	0	3.3
R0g-A0 & R1g-A1	0 or 3.3	0	0	3.3	0	0	0	3.3	0
R0a-A0 & R1a-A1	0 or 3.3	0	0	3.3	0	0	0	3.3	0

CAUTION: Although this device is designed to be as robust as possible, ESD (Electrostatic Discharge) can damage this device. This device must be protected at all times from ESD. Static charges may easily produce potentials of several kilovolts on the human body or equipment, which can discharge without detection. Industry-standard ESD precautions must be employed at all times.

802.11b,g Transmit Specifications (Tx Chain 0, Tx Chain 1)

Conditions: $V_{CC} = 3.3\text{ V}$, $T_{OP} = 25\text{ }^{\circ}\text{C}$. PA enables and control voltages set according to Mode Control Voltage table. Measurements made on Skyworks EVB with all losses de-embedded. All unused ports terminated into $50\ \Omega$ unless otherwise specified.

Parameter	Symbol	Condition	Min.	Typ.	Max.	Unit
Frequency range	F		2.4		2.5	GHz
Linear output power - g	Plin_g	54 Mbps OFDM, 64 QAM, EVM = 2.5 %		19		dBm
Compliant output power - b	P _{OUT_b}	11 Mbps CCK		19		dBm
Backed off EVM	BEVM	54 Mbps OFDM, 64 QAM, P _{OUT} = 8 dBm		1.5		%
1 dB compression point	P _{1 dB}		22.5	25		dBm
Small signal gain	S ₂₁			25		dB
Small signal gain variation over frequency band	ΔS ₂₁			1	2.5	dB
Gain matching, T0g to A0 vs. T1g to A1	S ₂₁ - M	Compared frequency by frequency		1		dB
Gain, 3.2–3.3 GHz	S ₂₁ - 3.2			-2	3	dB
Harmonics	2f, 3f	P _{OUT} = 18 dBm, 1 Mbps, CCK, 802.11b		-50	-42	dBm/MHz
Tx switching time	t _{sw}	50 % of V _{CTL} to 90/10 % RF output power level			500	ns
Input return loss	S ₁₁	T0g or T1g		-10		dB
Output return loss	S ₂₂	A0 or A1		-8		dB
Isolation between T0g and A1	ISO-A1	CW power into T0g and measure ratio of power at A0 to A1			-25	dBc
Isolation between T1g and A0	ISO-A0	CW power into T1g and measure ratio of power at A1 to A0			-25	dBc
Stability	STAB	P _{OUT} ≤ 18 dBm, load VSWR = 3:1	All non-harmonically related outputs less than -50 dBc/1 MHz			

802.11b,g Receive Specifications (Rx Chain 0, Rx Chain 1)

Conditions: $V_{CC} = 3.3\text{ V}$, $T_{OP} = 25\text{ }^{\circ}\text{C}$. PA enables & Tx control voltages = 0 V. Rx0ag or Rx1ag = 3.3 V. Measurements made on Skyworks EVB with all losses de-embedded. All unused ports terminated into $50\ \Omega$ unless otherwise specified.

Parameter	Symbol	Condition	Min.	Typ.	Max.	Unit
Frequency range	F		2.4		2.5	GHz
Insertion loss	S ₂₁			1.5	2.0	dB
Input return loss	S ₁₁	R0g or R1g		-20		dB
Output return loss	S ₂₂	A0 or A1		-15		dB
Insertion loss delta	ΔS ₂₁	A0 to R0g and A1 to R1g			0.5	dB

802.11b,g Power Detector Specification

Conditions: $V_{CC} = 3.3\text{ V}$, $T_{OP} = 25\text{ }^{\circ}\text{C}$. PU0g and Tx0ag or PU1g and Tx1ag = 3.3 V. RX0ag or RX1ag = 0 V. Measurements made on Skyworks EVB with all losses de-embedded. All unused ports terminated into $50\ \Omega$ unless otherwise specified.

Parameter	Symbol	Condition	Min.	Typ.	Max.	Unit
Frequency range	F		2.4		2.5	GHz
Power detect range	PDR	A0 or A1	0		20	dBm
Power detector accuracy	PDacc2	Over 3:1 VSWR		1		dB
DC load impedance	Zload				3	kohm
Output voltage, no RF			0.85		0.95	V
Output voltage, 20 dBm				0.35		V
Power detector -3 dB corner frequency	LPF-3 dB	10 kΩ load	270	300	400	kHz

802.11a Transmit Specifications (Tx Chain 0, Tx Chain 1)

Conditions: $V_{CC} = 3.3\text{ V}$, $T_{OP} = 25\text{ }^{\circ}\text{C}$. PA enables and control voltages set according to Mode Control Voltage table. Measurements made on Skyworks EVB with all losses de-embedded. All unused ports terminated into $50\ \Omega$ unless otherwise specified.

Parameter	Symbol	Condition	Min.	Typ.	Max.	Unit
Frequency range	F		4.9		5.85	GHz
Linear output power - a	Plin_a	54 Mbps OFDM, 64 QAM, EVM = 2.5 %		16		dBm
Backed off EVM	BEVM	54 Mbps OFDM, 64 QAM, $P_{OUT} = 7\text{ dBm}$		1.5		%
1 dB compression point	$P_{1\text{ dB}}$		21.5	24		dBm
Small signal gain	$ S_{21} $			24		dB
Small signal gain variation over any 20 MHz band	$ \Delta S_{21} $				0.5	dB
Gain matching, T0g to A0 vs. T1g to A1	$ S_{21} - M$	Compared frequency by frequency		2		dB
Gain, 3.2–3.9 GHz	$ S_{21} - 3.9$			0		dB
Harmonics	2f, 3f	$P_{OUT} = 18\text{ dBm}$, 1 Mbps, CCK, 802.11b		-50	-42	dBm/MHz
Tx switching time	t_{sw}	50 % of V_{CTL} to 90/10 % RF output power level			500	ns
Input return loss	$ S_{11} $	T0a or T1a		-6		dB
Output return loss	$ S_{22} $	A0 or A1		-10		dB
Isolation between T0g and A1	ISO-A1	CW power into T0a and measure ratio of power at A0 to A1			-25	dBc
Isolation between T1g and A0	ISO-A0	CW power into T1a and measure ratio of power at A1 to A0			-25	dBc
Stability	STAB	$P_{OUT} \leq 18\text{ dBm}$, load VSWR = 3:1	All non-harmonically related outputs less than -50 dBc/1 MHz			

802.11a Receive Specifications (Rx Chain 0, Rx Chain 1)

Conditions: $V_{CC} = 3.3\text{ V}$, $T_{OP} = 25\text{ }^{\circ}\text{C}$. PA enables & Tx control voltages = 0 V. Rx0ag or Rx1ag = 3.3 V. Measurements made on Skyworks EVB with all losses de-embedded. All unused ports terminated into $50\ \Omega$ unless otherwise specified.

Parameter	Symbol	Condition	Min.	Typ.	Max.	Unit
Frequency range	F		4.9		5.85	GHz
Insertion loss	$ S_{21} $			2.5	3	dB
Input return loss	$ S_{11} $	R0g or R1g		-20		dB
Output return loss	$ S_{22} $	A0 or A1		-15		dB
Insertion loss delta	$ \Delta S_{21} $	A0 to R0g and A1 to R1g			0.5	dB

802.11a Power Detector Specification

Conditions: $V_{CC} = 3.3\text{ V}$, $T_{OP} = 25\text{ }^{\circ}\text{C}$. PU0a and Tx0ag or PU1a and Tx1ag = 3.3 V. RX0ag or RX1ag = 0 V. Measurements made on Skyworks EVB with all losses de-embedded. All unused ports terminated into $50\ \Omega$ unless otherwise specified.

Parameter	Symbol	Condition	Min.	Typ.	Max.	Unit
Frequency range	F		4.9		5.85	GHz
Power detect range	PDR	A0 or A1	0		20	dBm
Power detector accuracy	PDacc5	Over 3:1 VSWR		0.7		dB
DC load impedance	Zload				3	kohm
Output voltage, no RF			0.85		0.95	V
Output voltage, 18 dBm				0.35		V
Power detector -3 dB corner frequency	LPF-3 dB	10 k Ω load	270	300	400	kHz

Typical Performance Data (2.4–2.5 GHz)

$V_{CC} = 3.3\text{ V}$, $T_A = 25\text{ }^\circ\text{C}$, OFDM 54 Mbps, $Z_0 = 50\ \Omega$, unless otherwise noted

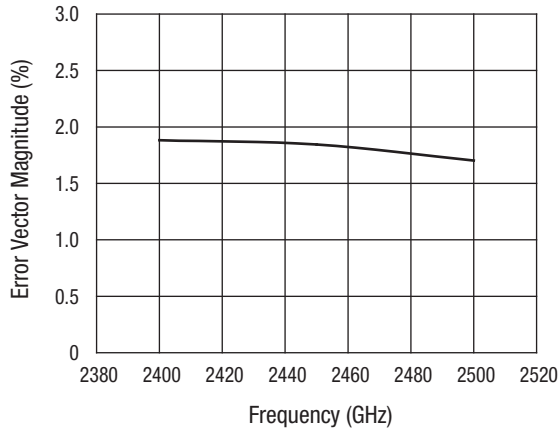

EVM vs. Frequency

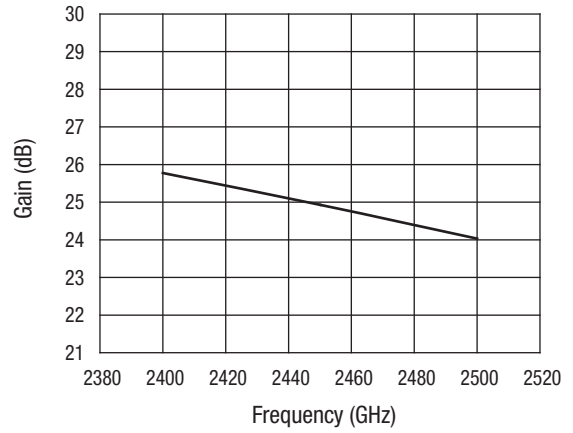

Gain vs. Frequency

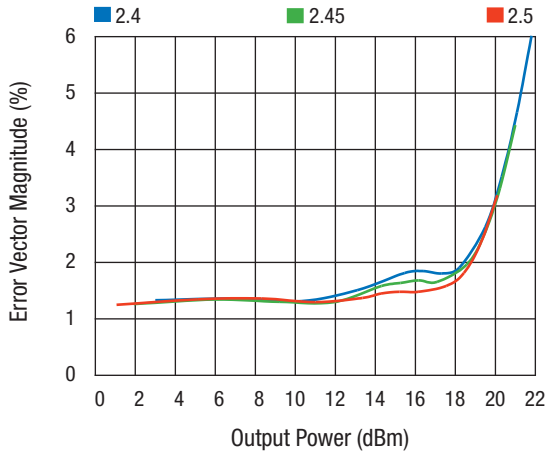

EVM vs. Output Power

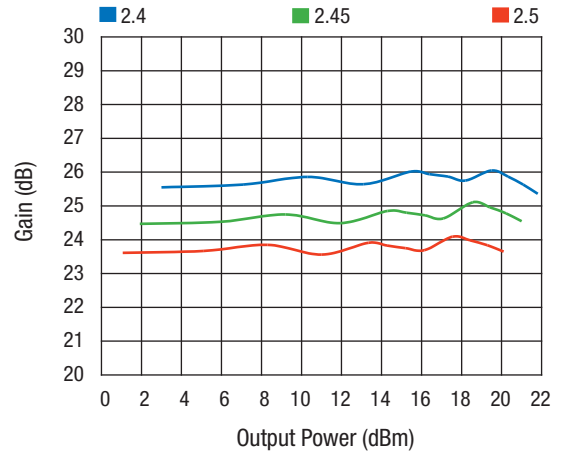

Gain vs. Output Power

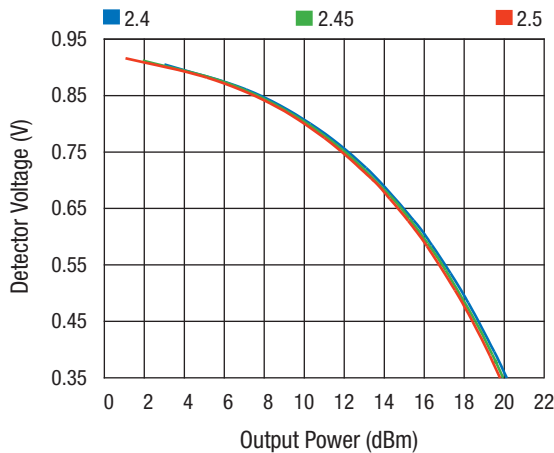

Detector Voltage vs. Output Power

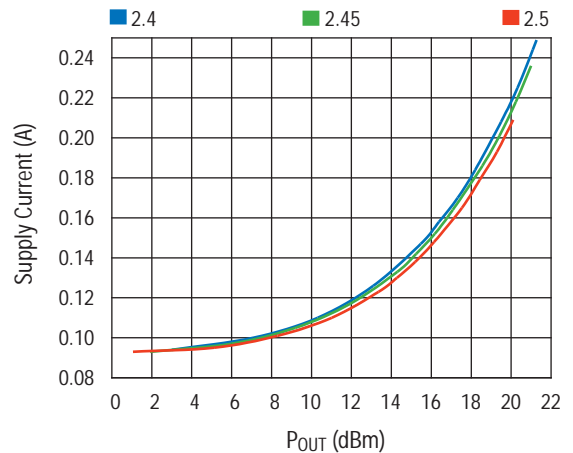

Supply Current vs. Output Power

Typical Performance Data (4.9–5.85 GHz)

$V_{CC} = 3.3\text{ V}$, $T_A = 25\text{ }^\circ\text{C}$, OFDM 54 Mbps, $Z_0 = 50\ \Omega$, unless otherwise noted

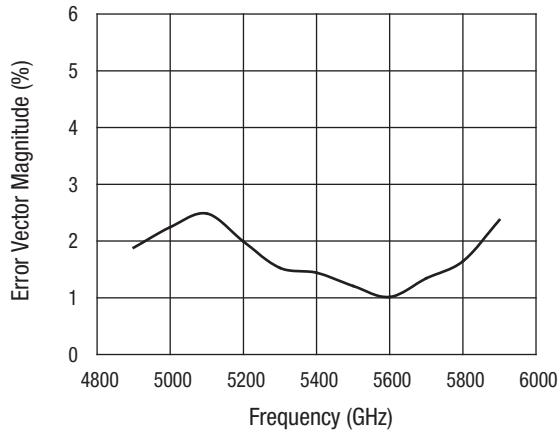

EVM vs. Frequency ($P_{OUT} = 15\text{ dBm}$)

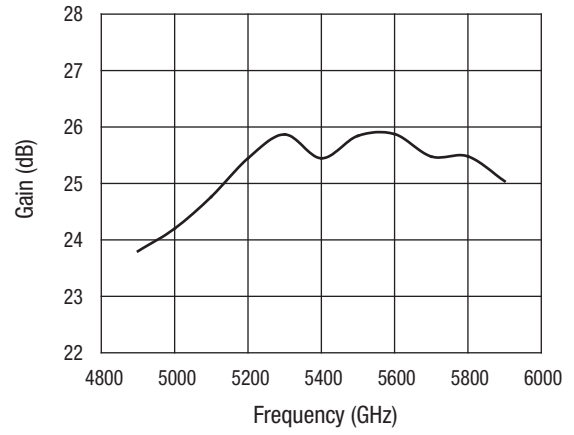

Gain vs. Frequency

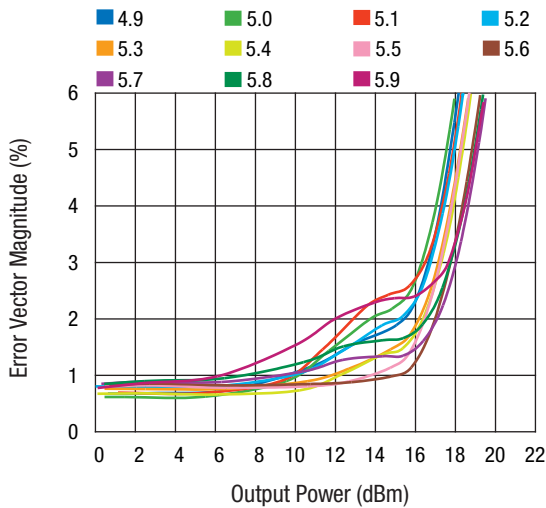

EVM vs. Output Power

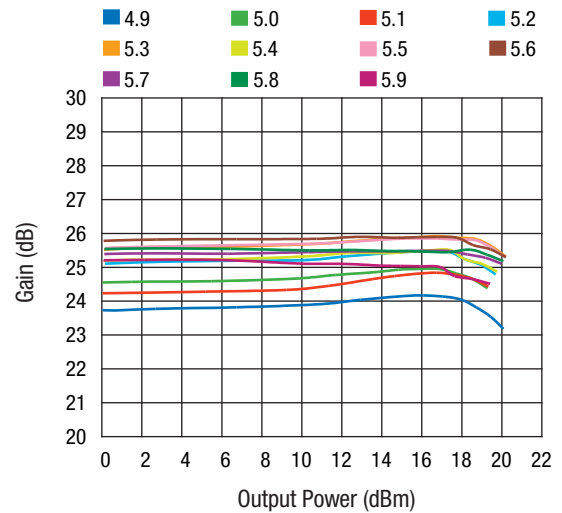

Gain vs. Output Power

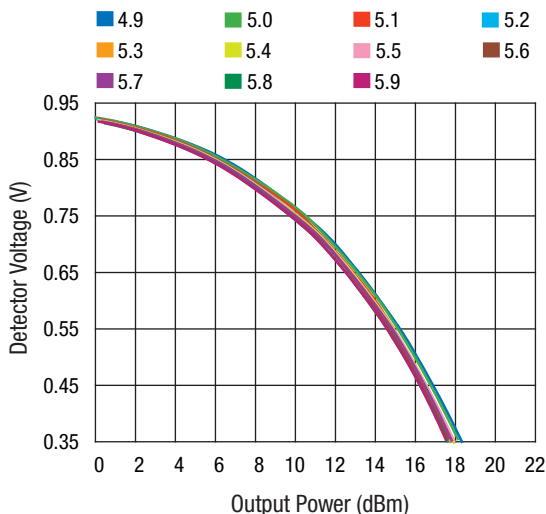

Detector Voltage vs. Output Power

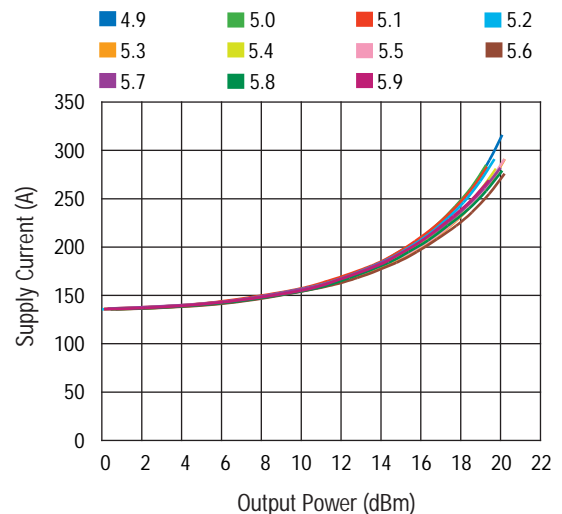

Supply Current vs. Output Power

Module Pin Out

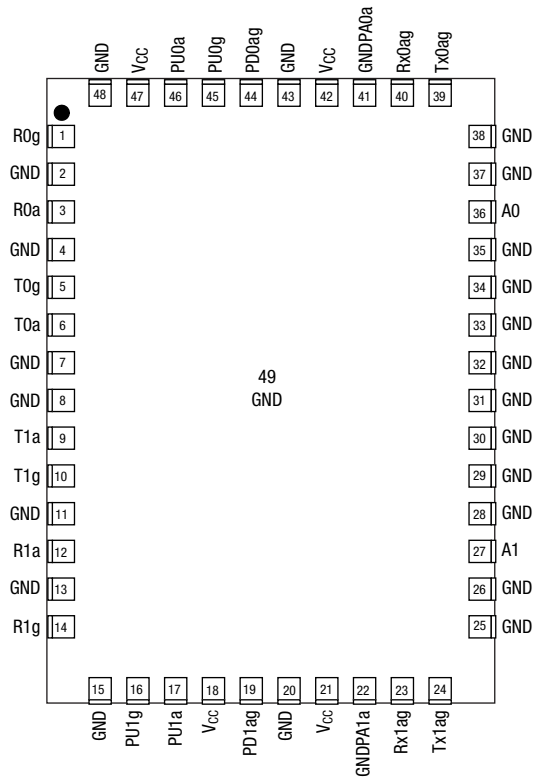

Pin Descriptions

Pin #	Name	Description	EVb Label
1	R0g	Receiver output	R0g
2	GND	Ground	GND
3	R0a	Receiver output	R0a
4	GND	Ground	GND
5	T0g	Transmitter input	T0g
6	T0a	Transmitter input	T0a
7	GND	Ground	GND
8	GND	Ground	GND
9	T1a	Transmitter input	T1a
10	T1g	Transmitter input	T1g
11	GND	Ground	GND
12	R1a	Receiver output	R1a
13	GND	Ground	GND
14	R1g	Receiver output	R1g
15	GND	Ground	GND
16	PU1g	Power amp enable input	VEN1g
17	PU1a	Power amp enable input	VEN1a
18	V _{CC}	3.3 V	None. Tied to Pin 47
19	PD1ag	Power detector 1 output	VD1ag
20	GND	Ground	GND
21	V _{CC}	3.3 V	None
22	GND PA1a	Ground	GND
23	Rx1ag	Switch control input	Rx1ag
24	Tx1ag	Switch control input	Tx1ag
25	GND	Ground	GND
26	GND	Ground	GND
27	A1	Antenna 1	A1
28	GND	Ground	GND
29	GND	Ground	GND
30	GND	Ground	GND
31	GND	Ground	GND
32	GND	Ground	GND
33	GND	Ground	GND
34	GND	Ground	GND
35	GND	Ground	GND
36	A0	Antenna 0	A0
37	GND	Ground	GND
38	GND	Ground	GND
39	Tx0ag	Switch control input	Tx0ag
40	Rx0ag	Switch control input	Rx0ag
41	GNDPA0a	Ground	GND
42	V _{CC}	3.3 V	None
43	GND	Ground	GND
44	PD0ag	Power detector 0 output	VD0ag
45	PU0g	Power amp enable input	VEN0g
46	PU0a	Power amp enable input	VEN0a
47	V _{CC}	3.3 V	V _{CC}
48	GND	Ground	GND
49	GND	Ground	GND

Recommended Footprint

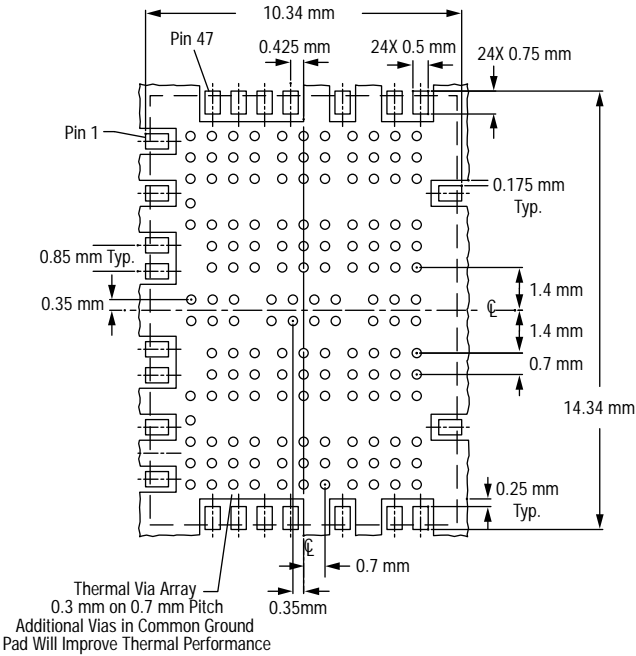

Thermal vias should be tented and filled with solder mask 30–35 µm copper plating recommended.

Solder Mask

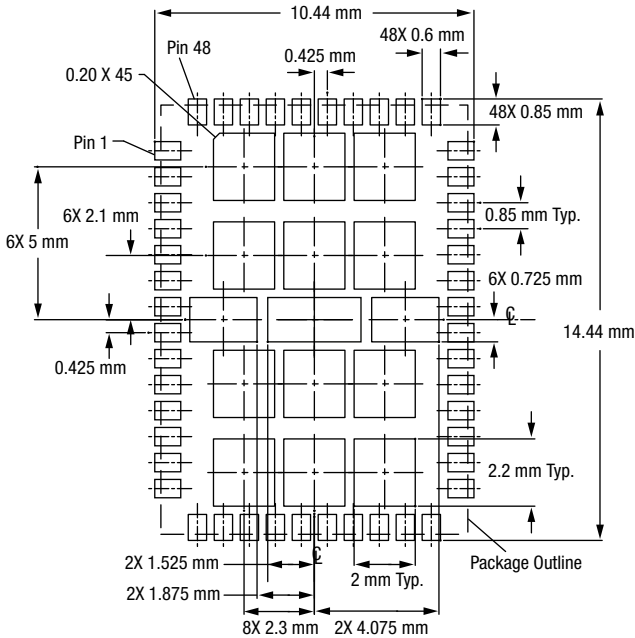

Stencil Pattern

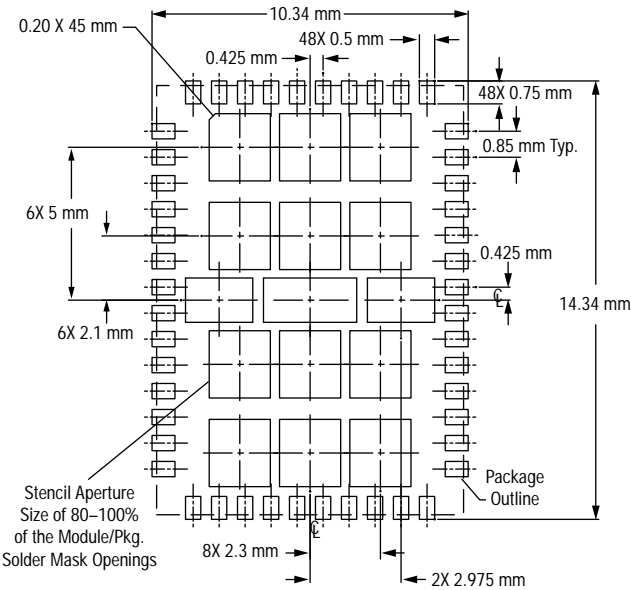

Package Outline

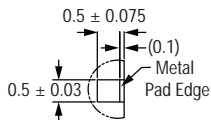
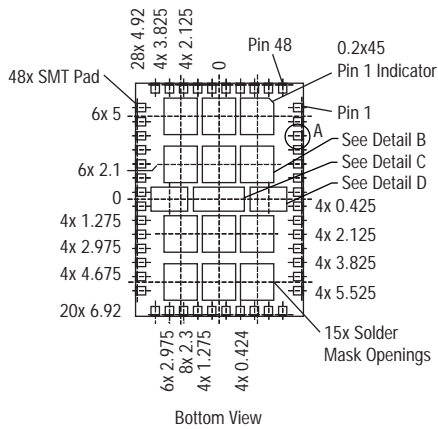
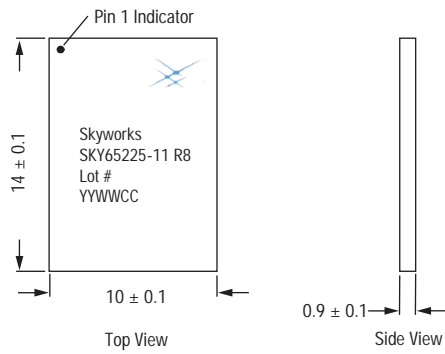

Detail A
Pad Scale: 2X
14X Rotated 180°
10X Rotated 90° CW
10X Rotated 90° CCW

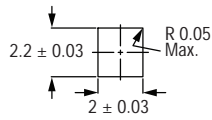

Detail B
Scale: Full
12X

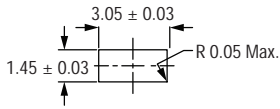

Detail C
Scale: Full

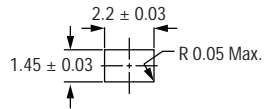

Detail D
Scale: Full
2X

Copyright © 2006, 2007, Skyworks Solutions, Inc. All Rights Reserved.

Information in this document is provided in connection with Skyworks Solutions, Inc. ("Skyworks") products or services. These materials, including the information contained herein, are provided by Skyworks as a service to its customers and may be used for informational purposes only by the customer. Skyworks assumes no responsibility for errors or omissions in these materials or the information contained herein. Skyworks may change its documentation, products, services, specifications or product descriptions at any time, without notice. Skyworks makes no commitment to update the materials or information and shall have no responsibility whatsoever for conflicts, incompatibilities, or other difficulties arising from any future changes.

No license, whether express, implied, by estoppel or otherwise, is granted to any intellectual property rights by this document. Skyworks assumes no liability for any materials, products or information provided hereunder, including the sale, distribution, reproduction or use of Skyworks products, information or materials, except as may be provided in Skyworks Terms and Conditions of Sale.

THE MATERIALS, PRODUCTS AND INFORMATION ARE PROVIDED "AS IS" WITHOUT WARRANTY OF ANY KIND, WHETHER EXPRESS, IMPLIED, STATUTORY, OR OTHERWISE, INCLUDING FITNESS FOR A PARTICULAR PURPOSE OR USE, MERCHANTABILITY, PERFORMANCE, QUALITY OR NON-INFRINGEMENT OF ANY INTELLECTUAL PROPERTY RIGHT; ALL SUCH WARRANTIES ARE HEREBY EXPRESSLY DISCLAIMED. SKYWORKS DOES NOT WARRANT THE ACCURACY OR COMPLETENESS OF THE INFORMATION, TEXT, GRAPHICS OR OTHER ITEMS CONTAINED WITHIN THESE MATERIALS. SKYWORKS SHALL NOT BE LIABLE FOR ANY DAMAGES, INCLUDING BUT NOT LIMITED TO ANY SPECIAL, INDIRECT, INCIDENTAL, STATUTORY, OR CONSEQUENTIAL DAMAGES, INCLUDING WITHOUT LIMITATION, LOST REVENUES OR LOST PROFITS THAT MAY RESULT FROM THE USE OF THE MATERIALS OR INFORMATION, WHETHER OR NOT THE RECIPIENT OF MATERIALS HAS BEEN ADVISED OF THE POSSIBILITY OF SUCH DAMAGE.

Skyworks products are not intended for use in medical, lifesaving or life-sustaining applications, or other equipment in which the failure of the Skyworks products could lead to personal injury, death, physical or environmental damage. Skyworks customers using or selling Skyworks products for use in such applications do so at their own risk and agree to fully indemnify Skyworks for any damages resulting from such improper use or sale.

Customers are responsible for their products and applications using Skyworks products, which may deviate from published specifications as a result of design defects, errors, or operation of products outside of published parameters or design specifications. Customers should include design and operating safeguards to minimize these and other risks. Skyworks assumes no liability for applications assistance, customer product design, or damage to any equipment resulting from the use of Skyworks products outside of stated published specifications or parameters.

Skyworks, the Skyworks symbol, "Breakthrough Simplicity" and Intera are trademarks or registered trademarks of Skyworks Solutions, Inc., in the United States and other countries. Third-party brands and names are for identification purposes only, and are the property of their respective owners. Additional information, including relevant terms and conditions, posted at www.skyworksinc.com, are incorporated by reference.