

# Six-String White LED Driver with Active Current Balancing for LCD Panel Applications

## General Description

The MAX8790A is a high-efficiency driver for white light-emitting diodes (LEDs). It is designed for large liquid-crystal displays (LCDs) that employ an array of LEDs as the light source. A current-mode step-up controller drives up to six parallel strings of multiple series-connected LEDs. Each string is terminated with ballast that achieves  $\pm 1.5\%$  current regulation accuracy, ensuring even brightness for all LEDs. The MAX8790A has a wide input-voltage range from 4.5V to 26V, and provides a fixed 20mA or adjustable 15mA to 27mA full-scale LED current.

The MAX8790A has two dimming control modes to enable a wide variety of applications. In direct DPWM mode, the LED current is directly turned on and off by a PWM signal. In analog dimming mode, an internal phase-locked loop (PLL) circuit translates the PWM signal into an analog signal and linearly controls the LED current down to 12.5%. Below 12.5%, digital dimming is added to allow lower average LED current down to 1%. Both control methods provide 100:1 dimming range.

The MAX8790A has multiple features to protect the controller from fault conditions. Separate feedback loops limit the output voltage if one or more LEDs fail open or short. The controller features cycle-by-cycle current limit to provide consistent operation and soft-start capability. A thermal-shutdown circuit provides another level of protection.

The step-up controller uses an external MOSFET, which provides good efficiency and allows for scalable output power and maximum operating voltage. Low feedback voltage at each LED string (450mV) helps reduce power loss. The MAX8790A features selectable switching frequency (500kHz, 750kHz, or 1MHz), which allows trade-offs between external component size and operating efficiency.

The MAX8790A is available in a thermally enhanced, lead-free, 20-pin, 4mm x 4mm, Thin QFN package.

## Applications

Notebook, Subnotebook, and Tablet Computer Displays

Automotive Systems

Handy Terminals

## Ordering Information

PART	TEMP RANGE	PIN-PACKAGE	PKG CODE
MAX8790AETP+	-40°C to +85°C	20 Thin QFN (4mm x 4mm)	T2044-3

+Denotes a lead-free package.

## Features

- ◆ Drives Six Parallel Strings with Multiple Series-Connected LEDs per String
- ◆  $\pm 1.5\%$  Current Regulation Accuracy Between Strings
- ◆ Low 450mV Feedback Voltage at Full Current Improves Efficiency
- ◆ Step-Up Controller Regulates the Output Just Above the Highest LED String Voltage
- ◆ Full-Scale LED Current Adjustable from 15mA to 27mA, or Preset 20mA
- ◆ Wide 100:1 Dimming Range
- ◆ Programmable Dimming Control: Direct DPWM or Analog Dimming
- ◆ Built-In PLL for Synchronized Dimming Control
- ◆ Open and Short LED Protections
- ◆ Output Overvoltage Protection
- ◆ Wide Input Voltage Range from 4.5V to 26V
- ◆ External MOSFET Allows a Large Number of LEDs per String
- ◆ 500kHz/750kHz/1MHz Switching Frequency
- ◆ Small, 20-Pin, 4mm x 4mm Thin QFN Package

## Simplified Operating Circuit

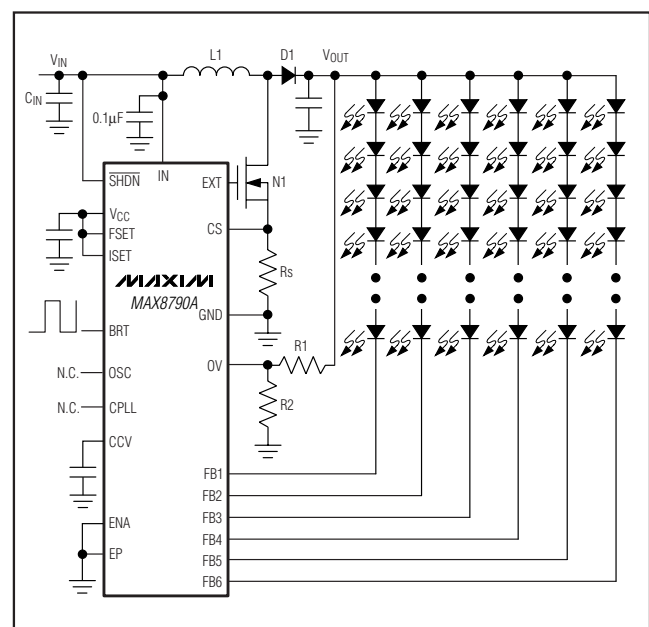

Pin Configuration appears at end of data sheet.

# Six-String White LED Driver with Active Current Balancing for LCD Panel Applications

## ABSOLUTE MAXIMUM RATINGS

IN,  $\overline{\text{SHDN}}$ , to GND .....-0.3V to +28V  
 FB\_ to GND .....-0.3V to +28V  
 V<sub>CC</sub>, BRT, ENA, OSC, OV to GND .....-0.3V to +6V  
 ISET, CCV, CS, FSET, CPLL, EXT to GND -0.3V to (V<sub>CC</sub> + 0.3V)  
 Continuous Power Dissipation (T<sub>A</sub> = +70°C)  
 20-Pin Thin QFN (derate 16.9mW/°C above +70°C) ...1349mW

Operating Temperature Range .....-40°C to +85°C  
 Junction Temperature .....+150°C  
 Storage Temperature Range .....-60°C to +150°C  
 Lead Temperature (soldering, 10s) .....+300°C

Stresses beyond those listed under "Absolute Maximum Ratings" may cause permanent damage to the device. These are stress ratings only, and functional operation of the device at these or any other conditions beyond those indicated in the operational sections of the specifications is not implied. Exposure to absolute maximum rating conditions for extended periods may affect device reliability.

## ELECTRICAL CHARACTERISTICS

(Circuit of Figure 1. V<sub>IN</sub> = 12V, V<sub>SHDN</sub> = V<sub>IN</sub>, CCV = 0.1μF, T<sub>A</sub> = 0°C to +85°C, unless otherwise noted. Typical values are at T<sub>A</sub> = +25°C.)

PARAMETER	CONDITIONS	MIN	TYP	MAX	UNITS
IN Input Voltage Range	V <sub>IN</sub> = V <sub>CC</sub>	4.5		5.5	V
	V <sub>CC</sub> = bypassed to GND through 1μF capacitor	5.5		26.0	
IN Quiescent Current	V <sub>SHDN</sub> = high, BRT = GND	V <sub>IN</sub> = 26V	1	2	mA
		V <sub>IN</sub> = V <sub>CC</sub> = 5V	1	2	
	$\overline{\text{SHDN}}$ = GND			10	μA
V <sub>CC</sub> Output voltage	V <sub>SHDN</sub> = 5V, 6V < V <sub>IN</sub> < 26V, 0 < I <sub>VCC</sub> < 10mA	4.7	5.0	5.3	V
V <sub>CC</sub> Short-Circuit Current		15	56	130	mA
V <sub>CC</sub> UVLO Threshold	Rising edge, hysteresis = 20mV	4.00	4.25	4.45	V
<b>STEP-UP CONVERTER</b>					
EXT High Level	10mA from EXT to GND	V <sub>CC</sub> - 0.1	V <sub>CC</sub>		V
EXT Low Level	-10mA from EXT to V <sub>CC</sub>		0	0.1	V
EXT On-Resistance	EXT high or low		2	5	Ω
EXT Sink/Source Current	EXT forced to 2V		1		A
OSC High-Level Threshold		V <sub>CC</sub> - 0.4			V
OSC Midlevel Threshold		1.5		V <sub>CC</sub> - 2.0	V
OSC Low-Level Threshold				0.4	V
Operating Frequency	V <sub>OSC</sub> = V <sub>CC</sub>	0.9	1.0	1.1	MHz
	V <sub>OSC</sub> = open	675	750	825	
	V <sub>OSC</sub> = GND	450	500	550	kHz
Minimum Duty Cycle	PWM mode		10		%
	Pulse skipping, no load		0		
Maximum Duty Cycle		94	95		%
CS Trip Voltage	Duty cycle = 75%	85	100	115	mV
<b>CONTROL INPUT</b>					
SHDN Logic-Input High Level		2.1			V
SHDN Logic-Input Low Level				0.8	V
BRT, ENA Logic-Input High Level		2.1			V
BRT, ENA Logic-Input Low Level				0.8	V

# Six-String White LED Driver with Active Current Balancing for LCD Panel Applications

MAX8790A

## ELECTRICAL CHARACTERISTICS (continued)

(Circuit of Figure 1.  $V_{IN} = 12V$ ,  $V_{SHDN} = V_{IN}$ ,  $CCV = 0.1\mu F$ ,  $T_A = 0^{\circ}C$  to  $+85^{\circ}C$ , unless otherwise noted. Typical values are at  $T_A = +25^{\circ}C$ .)

PARAMETER	CONDITIONS	MIN	TYP	MAX	UNITS
<b>INPUT LEAKAGE</b>					
SHDN Leakage Current	$\overline{SHDN} = 26V$			+42	$\mu A$
CS Leakage Current	$V_{CS} = GND$		+40	+50	$\mu A$
OSC Leakage Current		-3		+3	$\mu A$
BRT, ENA Leakage Current		-1		+1	$\mu A$
FSET, ISET Leakage Current	$FSET = ISET = V_{CC}$	-1		+1	$\mu A$
OV Leakage Current		-0.1		+0.1	$\mu A$
<b>LED CURRENT</b>					
Full-Scale FB_ Output Current	$ISET = V_{CC}$ , BRT = 100%	19.40	20.00	20.60	mA
	$R_{ISET} = 80k\Omega$ to GND, BRT = 100%	24.25	25.00	25.75	
	$R_{ISET} = 133k\Omega$ to GND, BRT = 100%	14.40	15.00	15.60	
ISET High-Level Threshold	Default setting for 20mA full-scale LED current	$V_{CC} - 0.4$			V
ISET Voltage		1.12	1.19	1.26	V
20% Output Current	$ISET = V_{CC}$ , BRT = 20%	3.84	4.00	4.16	mA
Current Regulation Between Strings	$ISET = V_{CC}$ , BRT = 100%	-1.5		+1.5	%
	$ISET = V_{CC}$ , BRT = 20%	-2.0		+2.0	%
Minimum FB_ Regulation Voltage	$R_{ISET} = 80k\Omega$ to GND, BRT = 100%	300	500	800	mV
	$ISET = V_{CC}$ , BRT = 100%	270	450	720	
	$ISET = V_{CC}$ , 12.5%	150	275	500	
Maximum FB_ Ripple	$ISET = V_{CC}$ , $C_{OUT} = 1\mu F$ , $OSC = V_{CC}$ (Note 1)		120	200	mV <sub>P-P</sub>
FB_ On-Resistance	$V_{FB_} = 50mV$		13	20	$\Omega$
FB_ Leakage Current	$\overline{SHDN} = GND$ , $V_{FB_} = 26V$			1	$\mu A$
	$\overline{SHDN} = V_{IN}$ , BRT = GND, $V_{FB_} = 15V$		10	28	
BRT Input Frequency		100		500	Hz
Minimum BRT Duty Cycle	PLL active		12.5		%
<b>FAULT PROTECTION</b>					
OV Threshold Voltage		1.16	1.23	1.30	V
FB_ Overvoltage Threshold		$V_{CC} + 0.20$	$V_{CC} + 0.6$	$V_{CC} + 1.45$	V
FAULT Shutdown Timer	$V_{FB_} > 5.6V$ (typ)	50	65	80	ms
Thermal-Shutdown Threshold	(Note 1)		170		$^{\circ}C$
<b>PHASE-LOCKED LOOP</b>					
FSET High-Level Threshold	PLL disabled	$V_{CC} - 0.4$			V
BRT Frequency Capture Range	$R_{FSET} = 500k\Omega$	150	200	250	Hz
	$R_{FSET} = 250k\Omega$	300	400	500	

# Six-String White LED Driver with Active Current Balancing for LCD Panel Applications

## ELECTRICAL CHARACTERISTICS

(Circuit of Figure 1.  $V_{IN} = 12V$ ,  $V_{SHDN} = V_{IN}$ ,  $CCV = 0.1\mu F$ ,  $T_A = -40^{\circ}C$  to  $+85^{\circ}C$ , unless otherwise noted.) (Note 2)

PARAMETER	CONDITIONS	MIN	TYP	MAX	UNITS
IN Input Voltage Range	$V_{IN} = V_{CC}$	4.5		5.5	V
	$V_{CC}$ bypassed to GND through $1\mu F$ cap	5.5		26.0	
IN Quiescent Current	$V_{BRT} = \text{high}$			2	mA
	$BRT = GND$	$V_{IN} = 26V$		2	
	$= GND$	$V_{IN} = V_{CC} = 5V$		10	$\mu A$
$V_{CC}$ Output Voltage	$V_{BRT} = 5V, 6V < V_{IN} < 26V, 0 < I_{VCC} < 10mA$	4.7		5.3	V
$V_{CC}$ Short-Circuit Current		12		130	mA
$V_{CC}$ UVLO Threshold	Rising edge, hysteresis = 20mV	4.00		4.45	V
<b>STEP-UP CONVERTER</b>					
EXT High Level	10mA from EXT to GND	$V_{CC} - 0.1$			V
EXT Low Level	-10mA from EXT to $V_{CC}$			0.1	V
EXT On-Resistance	EXT high or low			5	
OSC High-Level Threshold		$V_{CC} - 0.4$			V
OSC Midlevel Threshold		1.5		$V_{CC} - 2.0$	V
OSC Low-Level Threshold				0.4	V
Operating Frequency	$V_{OSC} = V_{CC}$	0.9		1.1	MHz
	$V_{OSC} = \text{open}$	675		825	kHz
	$V_{OSC} = GND$	450		550	
Maximum Duty Cycle		94			%
CS Trip Voltage	Duty cycle = 75%	85		115	mV
<b>CONTROL INPUT</b>					
Logic-Input High Level		2.1			V
Logic-Input Low Level				0.8	V
BRT, ENA Logic-Input High		2.1			V
BRT, ENA Logic-Input Low Level				0.8	V
<b>INPUT LEAKAGE</b>					
Leakage Current	$V_{IN} = 26V$			+42	$\mu A$
CS Leakage Current	$V_{CS} = GND$			+50	$\mu A$
OSC Leakage Current		-3		+3	$\mu A$
BRT, ENA Leakage Current		-1		+1	$\mu A$
FSET, ISET Leakage Current	$FSET = ISET = V_{CC}$	-1		+1	$\mu A$
OV Leakage Current		-0.1		+0.1	$\mu A$

# Six-String White LED Driver with Active Current Balancing for LCD Panel Applications

**MAX8790A**

## ELECTRICAL CHARACTERISTICS (continued)

(Circuit of Figure 1.  $V_{IN} = 12V$ ,  $V_{SHDN} = V_{IN}$ ,  $CCV = 0.1\mu F$ ,  $T_A = -40^{\circ}C$  to  $+85^{\circ}C$ , unless otherwise noted.) (Note 2)

PARAMETER	CONDITIONS	MIN	TYP	MAX	UNITS
<b>LED CURRENT</b>					
Full-Scale FB_ Output Current	ISET = V <sub>CC</sub> , BRT = 100%	19.2		20.8	mA
	R <sub>ISET</sub> = 80k $\Omega$ to GND, BRT = 100%	24.0		26.0	
	R <sub>ISET</sub> = 133k $\Omega$ to GND, BRT = 100%	14.4		15.6	
ISET High-Level Threshold	Default setting for 20mA full-scale LED current	V <sub>CC</sub> - 0.4			V
ISET Voltage		1.12		1.26	V
20% Output Current	ISET = V <sub>CC</sub> , BRT = 20%	3.8		4.2	mA
Current Regulation Between Strings	ISET = V <sub>CC</sub> , BRT = 100%	-2		+2	%
	ISET = V <sub>CC</sub> , BRT = 20%	-3		+3	
Minimum FB_ Regulation Voltage	R <sub>ISET</sub> = 80k $\Omega$ to GND, BRT = 100%	280		840	mV
	ISET = V <sub>CC</sub> , BRT = 100%	250		760	
	ISET = V <sub>CC</sub> , BRT = 12.5%	140		530	
Maximum FB_ Ripple	ISET = V <sub>CC</sub> , C <sub>OUT</sub> = 1 $\mu F$ , OSC = V <sub>CC</sub> (Note 1)			200	mV <sub>p-p</sub>
FB_ On-Resistance	V <sub>FB_</sub> = 50mV			20	$\Omega$
FB_ Leakage Current	$\overline{SHDN} = GND$ , V <sub>FB_</sub> = 26V			1	$\mu A$
	$\overline{SHDN} = V_{IN}$ , BRT = GND, V <sub>FB_</sub> = 15V			28	
BRT Input Frequency		100		500	Hz
<b>FAULT PROTECTION</b>					
OV Threshold Voltage		1.16		1.30	V
FB_ Overvoltage Threshold		V <sub>CC</sub> + 0.2		V <sub>CC</sub> + 1.45	V
FAULT Shutdown Timer	V <sub>FB_</sub> > 5.6V (typ)	50		80	ms
<b>PHASE-LOCKED LOOP</b>					
FSET High-Level Threshold	PLL disabled	V <sub>CC</sub> - 0.4			V
BRT Frequency Capture Range	R <sub>FSET</sub> = 500k $\Omega$	150		250	Hz
	R <sub>FSET</sub> = 250k $\Omega$	300		500	Hz

**Note 1:** Specifications are guaranteed by design, not production tested.

**Note 2:** Specifications to  $-40^{\circ}C$  are guaranteed by design, not production tested.

# Six-String White LED Driver with Active Current Balancing for LCD Panel Applications

## Typical Operating Characteristics

(Circuit configuration 1,  $V_{IN} = 12V$ ,  $V_{SHDN} = V_{IN}$ , LEDs = 8 series x 6 parallel strings,  $I_{SET} = V_{CC}$ ,  $T_A = +25^\circ C$ , unless otherwise noted.)

**BOOST CONVERTER EFFICIENCY vs. INPUT VOLTAGE (BRT = 100%)**

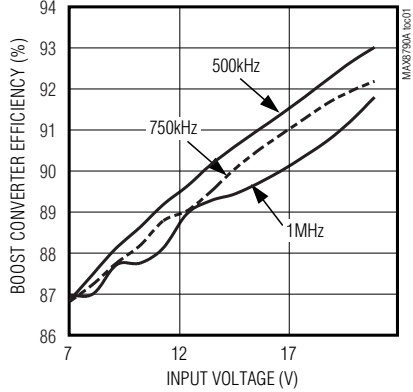

**NORMALIZED POWER vs. TOTAL LED CURRENT (ANALOG AND DPWM DIMMING)**

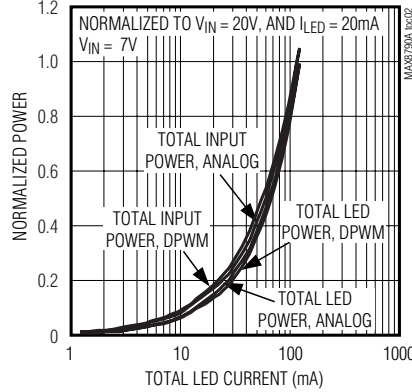

**LED CURRENT vs. BRT DUTY CYCLE (BRT AT 200Hz)**

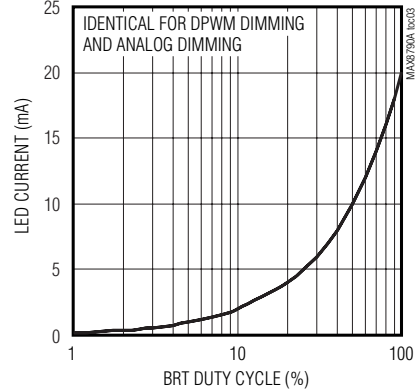

**LED CURRENT vs. AMBIENT TEMPERATURE (BRT = 100%)**

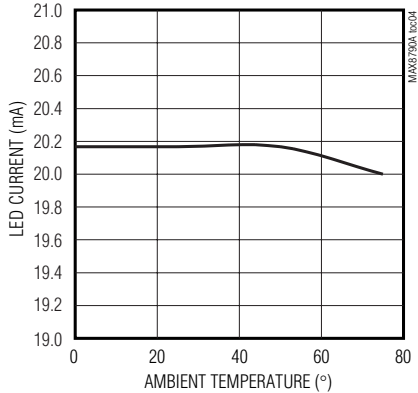

**LED CURRENT REGULATION vs. INPUT VOLTAGE**

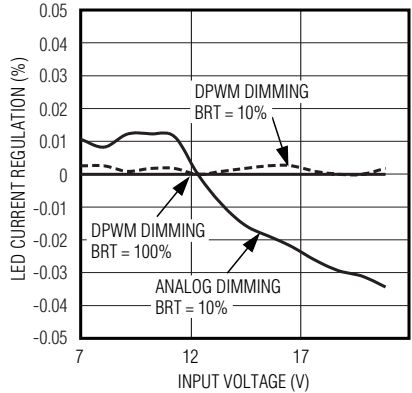

**FB\_ VOLTAGE vs. LED CURRENT (ANALOG DIMMING)**

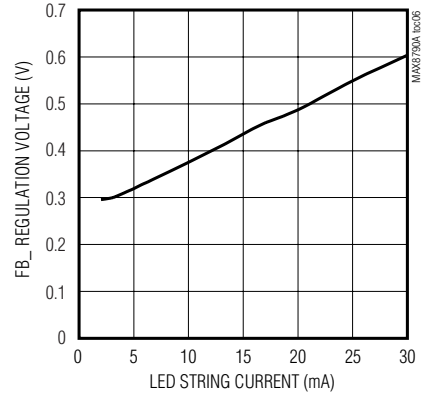

**SUPPLY CURRENT vs. INPUT VOLTAGE (DPWM DIMMING)**

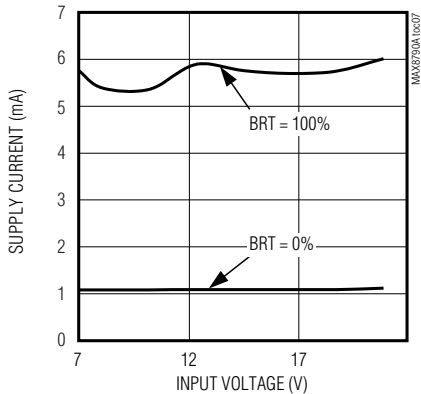

**SHUTDOWN CURRENT vs. INPUT VOLTAGE**

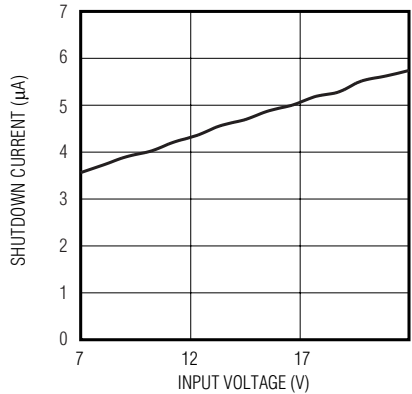

**SWITCHING WAVEFORMS (BRT = 100%)**

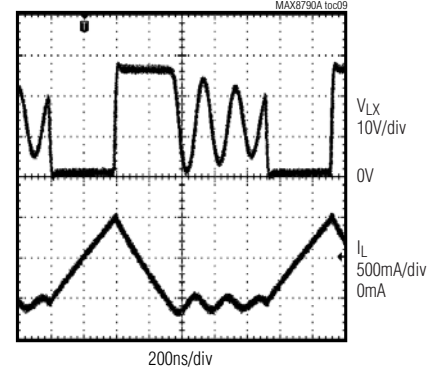

# Six-String White LED Driver with Active Current Balancing for LCD Panel Applications

**MAX8790A**

## Typical Operating Characteristics (continued)

(Circuit configuration 1,  $V_{IN} = 12V$ ,  $V_{SHDN} = V_{IN}$ , LEDs = 8 series x 6 parallel strings,  $I_{SET} = V_{CC}$ ,  $T_A = +25^\circ C$ , unless otherwise noted.)

**SWITCHING WAVEFORMS**  
(BRT = 15%, ANALOG DIMMING)

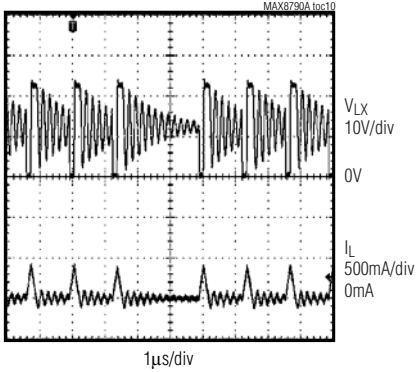

**STARTUP WAVEFORMS**  
(BRT = 100%, DPWM DIMMING)

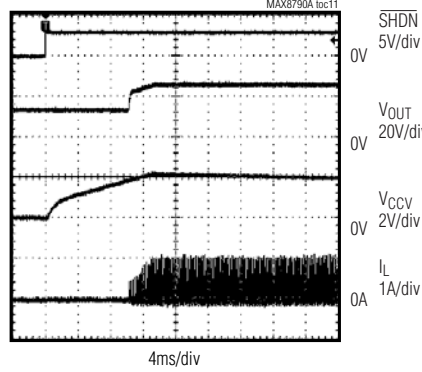

**LED CURRENT WAVEFORMS**  
(BRT = 50% AT 200Hz, DPWM DIMMING)

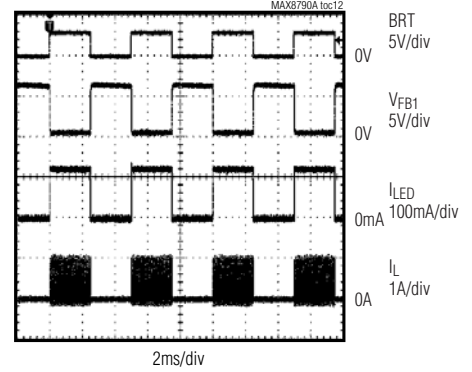

**LED CURRENT WAVEFORMS**  
(BRT = 1% AT 200Hz, DPWM DIMMING)

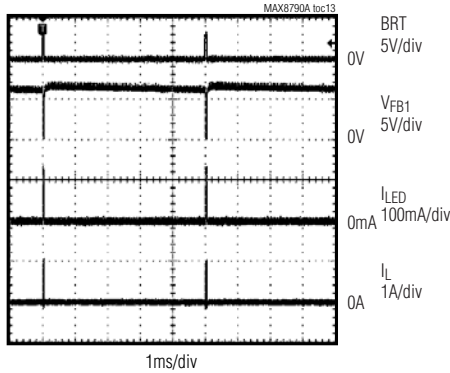

**LED CURRENT WAVEFORMS**  
(BRT = 50% AT 200Hz, ANALOG DIMMING)

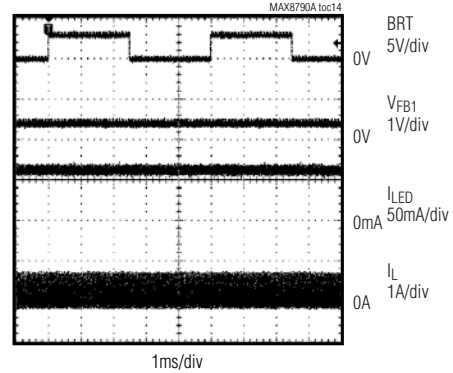

**LED CURRENT WAVEFORMS**  
(BRT = 1% AT 200Hz, ANALOG DIMMING)

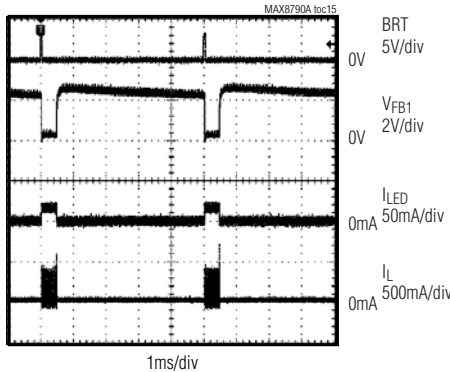

**LED-OPEN FAULT PROTECTION**  
(BRT = 100%, LED OPEN ON FB3)

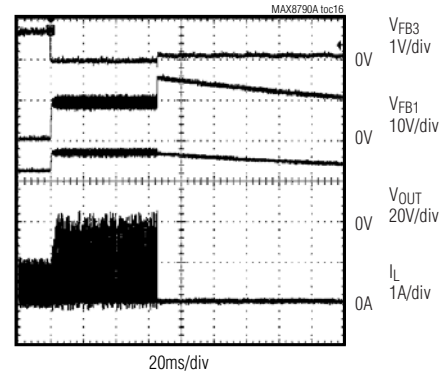



# Six-String White LED Driver with Active Current Balancing for LCD Panel Applications

## Typical Operating Characteristics (continued)

(Circuit configuration 1,  $V_{IN} = 12V$ ,  $V_{\overline{SHDN}} = V_{IN}$ , LEDs = 8 series x 6 parallel strings,  $I_{SET} = V_{CC}$ ,  $T_A = +25^\circ C$ , unless otherwise noted.)

**LED-SHORT FAULT PROTECTION  
(BRT = 100%, 2 LEDs SHORT ON FB3)**

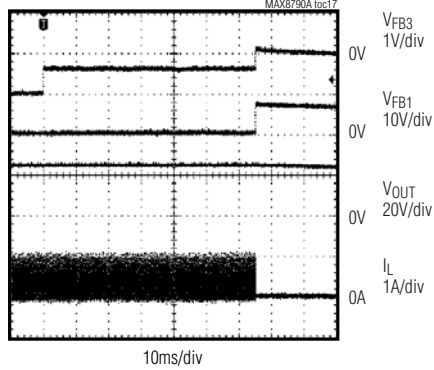

**LED CURRENT BALANCING  
vs. INPUT VOLTAGE (BRT = 100%)**

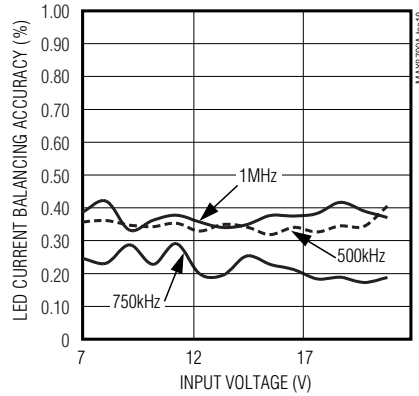

## Pin Description

PIN	NAME	FUNCTION
1	OSC	Oscillator Frequency Selection Pin. Connect OSC to $V_{CC}$ to set the step-up converter's oscillator frequency to 1MHz. Connect OSC to GND to set the frequency to 500kHz. Float OSC to set the frequency to 750kHz.
2	ENA	Analog Dimming Enable. ENA sets the PWM control mode. Set ENA LOW to enable direct DPWM dimming. Set ENA HIGH to enable analog dimming. In both modes, the duty cycle of the PWM signal at the BRT input controls the LED current characteristics. See the <i>Dimming Control</i> section for a complete description.
3	BRT	Brightness Control Input. The duty cycle of this digital input signal controls the LED current characteristics. The allowable frequency range is 100Hz to 500Hz in analog dimming mode. The duty cycle can be 100% to 1%. The BRT frequency can go above 500Hz in direct DPWM mode as long as the BRT pulse width is greater than 50 $\mu$ s minimum. See the <i>Dimming Control</i> section for a complete description.
4	$\overline{SHDN}$	Shutdown Control Input. The MAX8790A shuts down when $\overline{SHDN}$ is less than 0.8V. Pulling $\overline{SHDN}$ above 2.1V enables the MAX8790A. $\overline{SHDN}$ can be connected to the input voltage if desired.
5	FB1	LED String 1 Cathode Connection. FB1 is the open-drain output of an internal regulator, which controls current through FB1. FB1 can sink up to 27mA. If unused, connect FB1 to GND.
6	FB2	LED String 2 Cathode Connection. FB2 is the open-drain output of an internal regulator, which controls current through FB2. FB2 can sink up to 27mA. If unused, connect FB2 to GND.
7	FB3	LED String 3 Cathode Connection. FB3 is the open-drain output of an internal regulator, which controls current through FB3. FB3 can sink up to 27mA. If unused, connect FB3 to GND.
8	GND	Ground
9	FB4	LED String 4 Cathode Connection. FB4 is the open-drain output of an internal regulator, which controls current through FB4. FB4 can sink up to 27mA. If unused, connect FB4 to GND.
10	FB5	LED String 5 Cathode Connection. FB5 is the open-drain output of an internal regulator, which controls current through FB5. FB5 can sink up to 27mA. If unused, connect FB5 to GND.



# Six-String White LED Driver with Active Current Balancing for LCD Panel Applications

## Pin Description (continued)

MAX8790A

PIN	NAME	FUNCTION
11	FB6	LED String 6 Cathode Connection. FB6 is the open-drain output of an internal regulator, which controls current through FB6. FB6 can sink up to 27mA. If unused, connect FB6 to GND.
12	CS	Step-Up Controller Current-Sense Input. Connect the CS input to a ground-referenced sense resistor to measure the current in the external MOSFET switch.
13	EXT	External MOSFET Gate-Drive Output
14	OV	Overtoltage Sense. Connect OV to the center tap of a resistive voltage-divider from V <sub>OUT</sub> to ground. The detection threshold for voltage limiting at OV is 1.23V (typ).
15	V <sub>CC</sub>	5V Linear Regulator Output. V <sub>CC</sub> provides power to the MAX8790A and is also used to bias the gate driver for the external MOSFET. Bypass V <sub>CC</sub> to GND with a ceramic capacitor of 1μF or greater. If V <sub>IN</sub> is less than or equal to 5.5V, connect V <sub>CC</sub> to IN to the disable the internal LDO and use the external 5V supply to V <sub>CC</sub> . When SHDN is low, the internal linear regulator is disabled.
16	IN	Supply Input. V <sub>IN</sub> biases the internal 5V linear regulator that powers the device. Bypass IN to GND directly at the pin with a 0.1μF or greater ceramic capacitor.
17	CCV	Step-Up Converter Compensation Pin. Connect a 0.1μF ceramic capacitor and 1.2kΩ resistor from CCV to GND. When the MAX8790A shuts down, CCV is discharged to 0V through an internal 20kΩ resistor.
18	ISET	Full-Scale LED Current Adjustment Pin. The resistance from ISET to GND controls the full-scale current in each LED string: $I_{LEDmax} = 20mA \times 100k\Omega / R_{ISET}$ The acceptable resistance range is 74kΩ < R <sub>ISET</sub> < 133kΩ, which corresponds to full-scale LED current of 27mA > I <sub>LEDmax</sub> > 15mA. Connect ISET to V <sub>CC</sub> for a default full-scale LED current of 20mA.
19	FSET	PLL Free-Running Frequency Control Pin. The resistance from FSET to GND controls the PLL oscillator's free-running frequency, f <sub>PLL</sub> : $f_{PLL} = 1 / (10 \times R_{FSET} \times 800pF)$ The capture range is 0.6 x f <sub>PLL</sub> to f <sub>PLL</sub> . The acceptable resistance range for FSET is 250kΩ < R <sub>FSET</sub> < 754kΩ, which corresponds to a frequency range of 500Hz > f <sub>PLL</sub> > 166Hz. The resulting capture frequency range is 100Hz to 500Hz.
20	CPLL	Phase-Locked Loop-Compensation Capacitor Pin. The capacitance at CPLL compensates the PLL loop response. Connect a 0.1μF ceramic capacitor from CPLL to GND.
EP	EP	Exposed Backside Pad. Solder to the circuit board ground plane with sufficient copper connection to ensure low thermal resistance. See the <i>PCB Layout Guidelines</i> section.

# Six-String White LED Driver with Active Current Balancing for LCD Panel Applications

## Detailed Description

The MAX8790A is a high-efficiency driver for arrays of white LEDs. It contains a fixed-frequency, current-mode, PWM step-up controller, 5V linear regulator, dimming control circuit, and six regulated current sources (see Figure 2). When enabled, the step-up controller boosts the output voltage to provide sufficient headroom for the current sources to regulate their respective string currents. The MAX8790A features selectable switching frequency (500kHz, 750kHz, or 1MHz), which allows trade-offs between external component size and operating efficiency. The control architecture automatically skips pulses at light loads to improve efficiency and prevents overcharging the output capacitor.

A PWM logic input signal, BRT, controls the LED brightness. The MAX8790A supports both analog and digital control of the LED current, and achieves 100:1 dimming range. The MAX8790A's dimming control circuit consists of a PLL, a digital comparator, and a DAC. In direct DPWM mode, the step-up controller and current source

are directly turned on and off by the PWM signal. In analog dimming mode, an internal PLL, digital comparator, and DAC circuit translate the PWM signal into an analog signal that linearly controls the LED current, down to a PWM duty factor of 12.5%.

The MAX8790A has multiple features to protect the controller from fault conditions. Separate feedback loops limit the output voltage if one or more LEDs fail open or short. During operation, if one of the feedback string voltages exceeds the  $V_{CC}$  to 0.6V (typ) protection threshold, the controller shuts down and latches off after an internal timer expires. The controller features cycle-by-cycle current limit to provide consistent operation and soft-start capability. A thermal-shutdown circuit provides another level of protection.

The MAX8790A includes a 5V linear regulator that provides the internal bias and gate drive for the step-up controller. When an external 5V is available, the internal LDO can be overdriven to decrease power dissipation. Otherwise, connect the IN pin to an input greater than 5.5V. The internal LDO is disabled when SHDN is low.

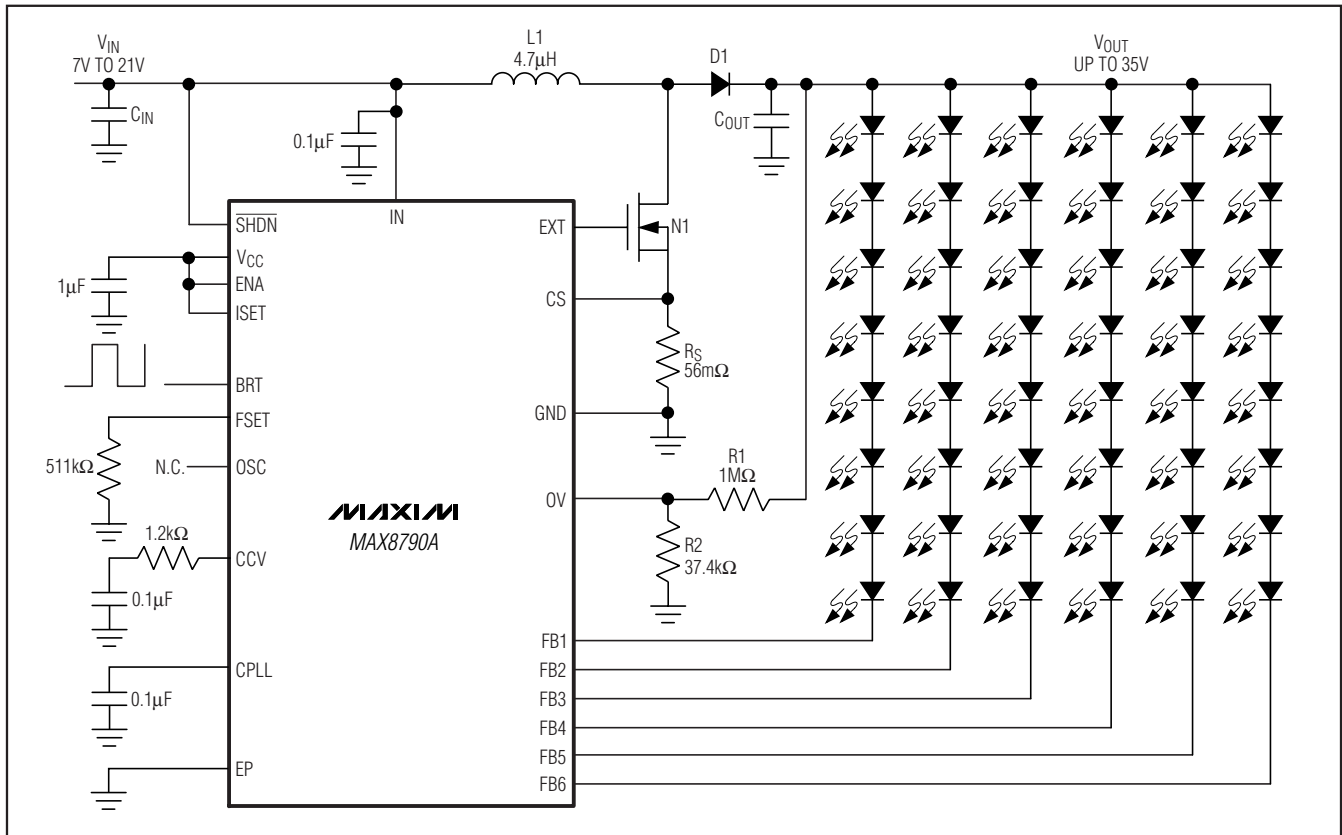

Figure 1. Typical Operating Circuit

# Six-String White LED Driver with Active Current Balancing for LCD Panel Applications

**MAX8790A**

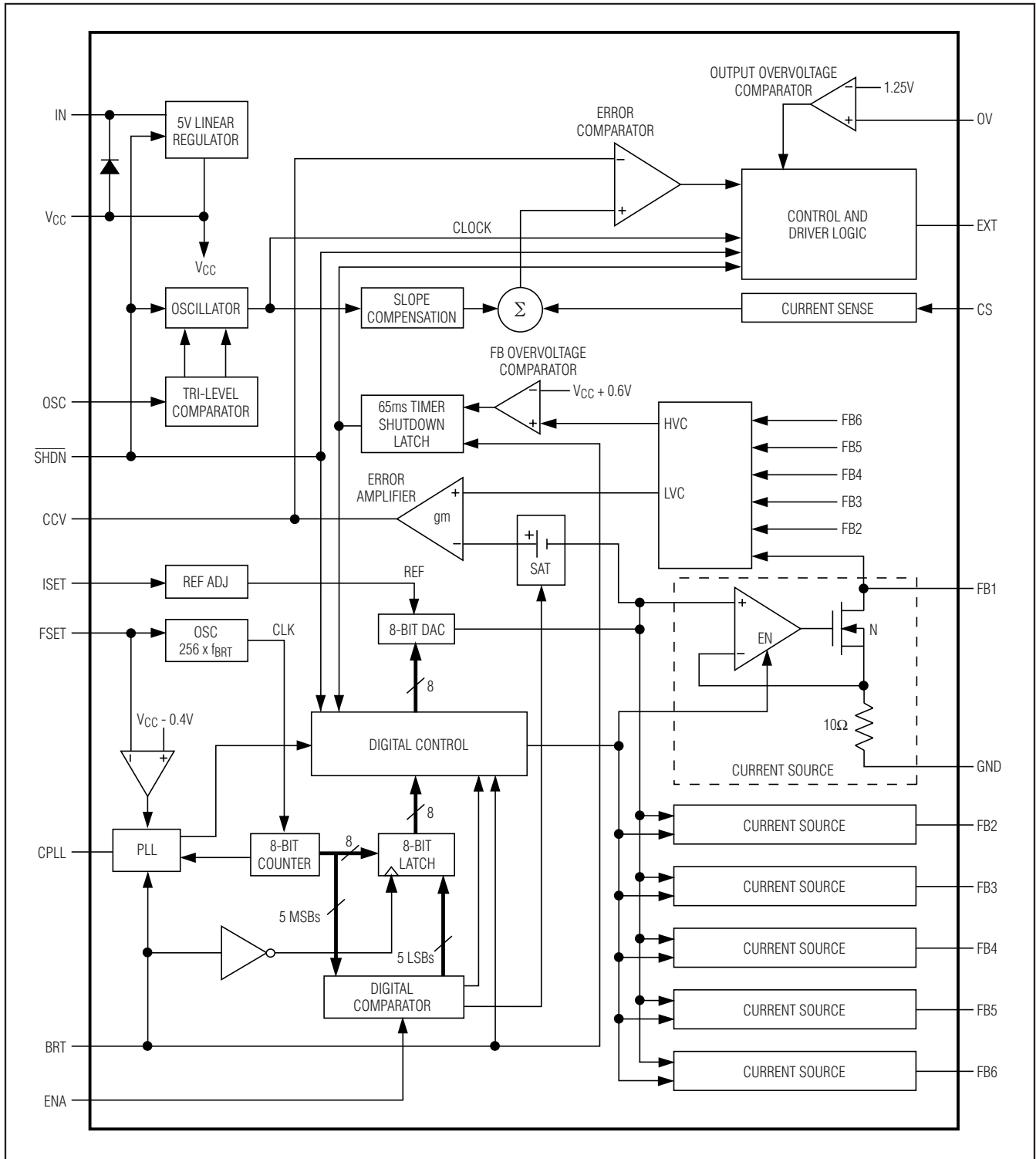

Figure 2. Control Circuit Block Diagram

# Six-String White LED Driver with Active Current Balancing for LCD Panel Applications

## Fixed-Frequency Step-Up Controller

The MAX8790A's fixed-frequency, current-mode, step-up controller automatically chooses the lowest active FB\_ voltage to regulate the feedback voltage. Specifically, the difference between the lowest FB\_ voltage and the current source-control signal plus an offset ( $V_{SAT}$ ) is integrated at the CCV output. The resulting error signal is compared to the external switch current plus slope compensation to terminate the switch on-time. As the load changes, the error amplifier sources or sinks current to the CCV output to adjust the required peak inductor current. The slope-compensation signal is added to the current-sense signal to improve stability at high duty cycles.

At light loads, the MAX8790A automatically skips pulses to improve efficiency and prevent overcharging the output capacitor. In SKIP mode, the inductor current ramps up for a minimum on-time of approximately 150ns, then discharges the stored energy to the output. The switch remains off until another pulse is needed to boost the output voltage.

## Internal 5V Linear Regulator $V_{CC}$ and UVLO

The MAX8790A includes an internal low-dropout linear regulator ( $V_{CC}$ ). When  $V_{IN}$  is higher than 5.5V and  $\overline{SHDN}$  is high, this linear regulator generates a 5V supply to power an internal PWM controller, control logic, and MOSFET driver. This linear regulator can deliver at least 10mA of total additional load current. If  $V_{IN}$  is less than or equal to 5.5V,  $V_{CC}$  and IN can be connected together and powered from an external 5V supply. There is an internal diode from  $V_{CC}$  to IN, so  $V_{IN}$  must be greater than  $V_{CC}$  (see Figure 2).

The MAX8790A includes UVLO protection. The controller is disabled until  $V_{CC}$  exceeds the UVLO threshold of 4.25V (typ). Hysteresis on UVLO is approximately 20mV.

The  $V_{CC}$  pin should be bypassed to GND with a 1 $\mu$ F or greater ceramic capacitor.

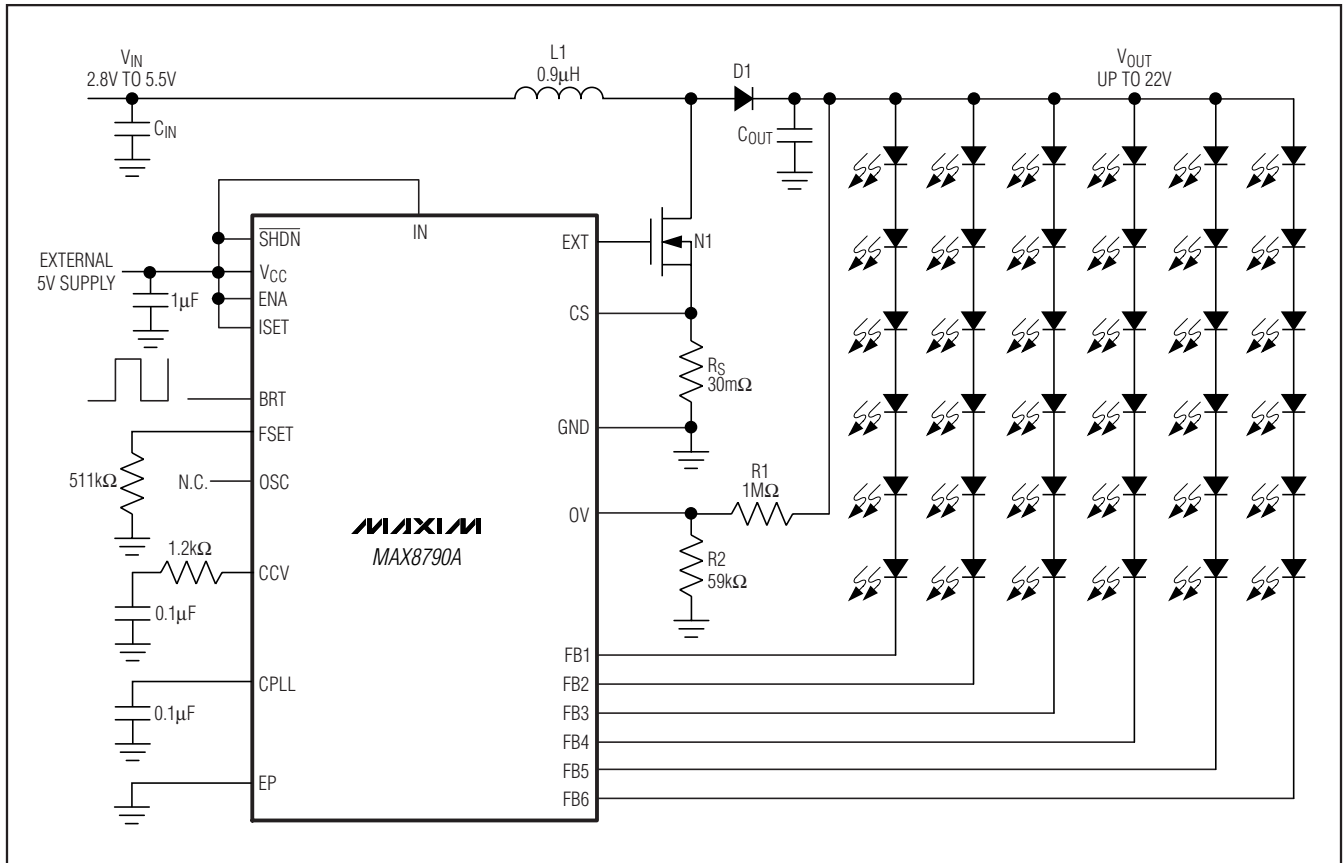

Figure 3. Low-Input-Voltage Application Circuit

# Six-String White LED Driver with Active Current Balancing for LCD Panel Applications

## Startup

At startup, the MAX8790A checks each FB\_ pin to determine if the respective current string is enabled. Each FB\_ pin is internally pulled up with a 180 $\mu$ A current source. If an FB\_ pin is connected to GND, the corresponding string current source is disabled. This feedback scan takes approximately 4.2ms, after which the step-up converter begins switching.

## Shutdown

When the  $\overline{\text{SHDN}}$  pin is less than 0.8V, the MAX8790A shuts down the internal LDO, the reference, current sources, and all control circuitry. The resulting supply current is less than 10 $\mu$ A. While the n-channel MOSFET is turned off, the step-up regulator's output is connected to IN through the external inductor and rectifier diode.

## Frequency Selection

A tri-level OSC input sets the internal oscillator frequency for the step-up converter, as shown in Table 1. High-frequency (1MHz) operation optimizes the regulator for the smallest component size, at the expense of efficiency due to increased switching losses. Low-frequency (500kHz) operation offers the best overall efficiency, but requires larger components and PCB area.

**Table 1. Frequency Selection**

OSC	SWITCHING FREQUENCY (kHz)
GND	500
Open	750
V <sub>CC</sub>	1000

## Overvoltage Protection

To protect the step-up converter when the load is open, or the output voltage becomes excessive for any reason, the MAX8790A features a dedicated overvoltage feedback input (OV). The OV pin is connected to the center tap of a resistive voltage-divider from the high-voltage output (see Figure 1). When the MAX8790A is powered up, if none of the LED strings on FB1–FB6 are connected to the step-up converter output, the step-up converter regulates the output voltage to  $V_{\text{OUT}} = 1.23\text{V}(1 + R1 / R2)$ . When  $V_{\text{OV}}$  exceeds 1.23V, a comparator turns off N1. The step-up converter switch is reenabled after the output voltage drops below the protection threshold.

## LED Current Sources

Maintaining uniform LED brightness and dimming capability are critical for LCD backlight applications.

The MAX8790A is equipped with a bank of six matched current sources. These specialized current sources are accurate to within  $\pm 1.5\%$  and can be switched on and off within 10 $\mu$ s, enabling PWM frequencies of up to 2kHz. All LED full-scale currents are identical and are set through the ISET pin ( $15\text{mA} < I_{\text{LED}} < 27\text{mA}$ ).

The minimum voltage drop across each current source is approximately 450mV at 20mA. The low voltage drop helps reduce dissipation while maintaining sufficient compliance to control the LED current within the required tolerances.

The LED current sources can be disabled by grounding the respective FB\_ pin at startup. When the IC is powered up, the controller scans settings for all FB\_ pins. If an FB\_ pin is not grounded, an internal circuit pulls this pin high, and the controller enables the corresponding current source to regulate the string current. If the FB\_ pin is grounded, the controller disables the corresponding current regulator. The current regulator cannot be disabled by grounding any of the FB\_ pins after the IC is powered up.

All FB\_ pins in use are measured and the highest signal (HVC) and the lowest signal (LVC) are extracted for two feedback loops. HVC is used to identify excessive dissipation across the current-source inputs. When HVC is greater than  $V_{\text{CC}} + 0.6\text{V}$  (typ) for greater than 65ms (see the *Current-Source Fault Protection* section), a fault latch is set and the MAX8790A is shut down. The LDO output is not affected by the fault latch. LVC is fed into the step-up converter's error amplifier to regulate the step-up converter's output voltage.

## Current-Source Fault Protection

The LED current sources are protected against string open, short, and gross mismatch faults, using overvoltage detection circuitry on each FB\_ pin. If any of these three fault conditions persists for a preset duration, the MAX8790A is latched off. The duration of the fault time depends on the dimming mode and the duty cycle of the BRT input (DBRT). In the DPWM mode, the timeout interval is:

$$t_{\text{TIMEOUT\_DPWM}} = 65\text{ms}/\text{DBRT}$$

In analog dimming mode, the fault time is fixed at 65ms for DBRT greater than 12.5%. When DBRT is less than 12.5%, the timeout interval is:

$$t_{\text{TIMEOUT\_ANALOG}} = 8.125\text{ms}/\text{DBRT}$$

The fault latch can be cleared by cycling the power or toggling the shutdown pin SHDN.

# Six-String White LED Driver with Active Current Balancing for LCD Panel Applications

## Open-Current Source Protection

The MAX8790A step-up converter output voltage is regulated according to the minimum value of the enable FB\_ voltages. If an individual LED string is open, the respective FB\_ is pulled down to near ground. In this situation, the step-up converter output voltage increases but is clamped to a level set with the OV feedback input. When this elevated output voltage is applied to the undamaged strings, excessive voltage drop develops across the FB\_ pins. If the resulting HVC signal exceeds  $V_{CC} + 0.6V$  for greater than 65ms, the fault latch is triggered to protect the circuit.

## LED-Short and String Mismatch Protection

Normally, white LEDs have variations in forward-voltage drop of 3.1V to 3.6V. The MAX8790A can tolerate slight mismatches between LED strings. When the sum of the LED forward voltages creates a mismatch in the strings so the HVC signal exceeds  $V_{CC} + 0.6V$  for greater than 65ms, the fault latch is triggered in much the same way as the circuit responds to open string faults. Similar protection is activated when an LED is shorted.

The larger the number of series-connected LEDs (N), the smaller the tolerable mismatch between LEDs:

$$\sum \frac{\text{Error}}{N} < V_{CC} + 0.6V - V_{SAT}$$

$$V_{SAT} \approx 450\text{mV and } V_{CC} = 5V$$

$$\sum \frac{\text{Error}}{N} < 5.150V$$

$$\text{Average Error Per LED} = \frac{5.150V}{N}$$

For N = 8, the average error per LED = 644mV.

For N = 10, the average error per LED = 510mV.

The larger the total mismatch, the larger the voltage drop required across each current source to correct for the error, and therefore the larger the dissipation within the MAX8790A.

## Dimming Control

The MAX8790A features both analog and digital dimming control. Analog dimming can provide potentially higher converter efficiency because of low voltage drop across each WLED when the current is low. Digital dimming (DPWM) provides less WLED color distortion since the WLED current is held at full scale when the WLED is on.

The MAX8790A's dimming control circuit consists of a PLL, a digital comparator, and a DAC. The controller provides 100:1 dimming range through either analog or digital control methods. Both methods translate the duty cycle of the BRT input into a control signal for the LED current sources. In analog dimming mode, the current-source outputs are DC and the BRT duty cycle ( $12.5\% < D_{BRT} < 100\%$ ) modulates the amplitude of the currents. For  $D_{BRT} < 12.5\%$ , the LED current is digitally modulated to reduce the average LED current down to 1% of full scale. The PLL detects the BRT frequency and phase, and adjusts the current-source amplitude and duty cycle synchronously (see Figure 4).

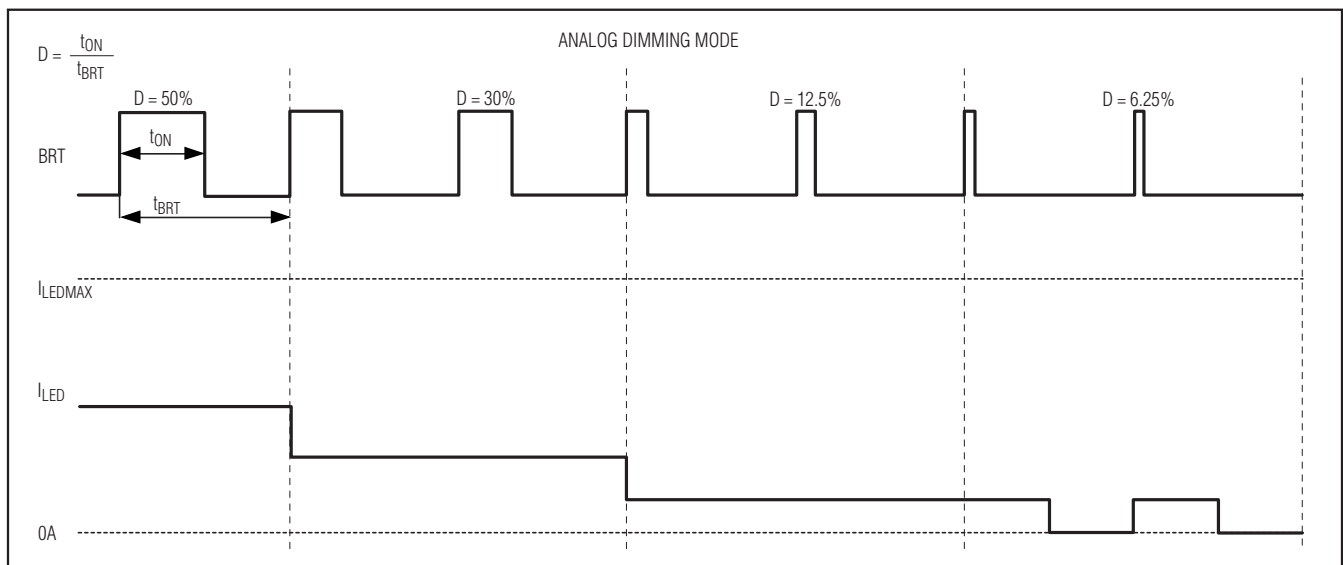

Figure 4. LED Current Control Using Analog Dimming Mode

# Six-String White LED Driver with Active Current Balancing for LCD Panel Applications

In digital dimming mode, the step-up controller and current source are directly turned on and off by the PWM signal. The current pulse magnitude, or full-scale current, is set by ISET and is independent of PWM duty factor. The current-source outputs are PWM signals synchronized to the BRT input signal (see Figure 5).

The full-scale current in both methods is specified by resistance from the ISET pin to ground:

$$I_{LEDmax} = \frac{20mA \times 100k\Omega}{R_{ISET}}$$

The acceptable resistance range is  $74k\Omega < R_{ISET} < 133k\Omega$ , which corresponds to full-scale LED current of  $27mA > I_{LEDmax} > 15mA$ . Connect ISET to VCC for a default full-scale LED current of 20mA. When ENA is high, the analog dimming is enabled, when ENA is low, digital dimming is enabled.

When the current-source output is pulse-width modulated, current-source turn-on is synchronized with the BRT signal. Synchronization and low jitter in the PWM signals help reduce flicker noise in the display. The current through each FB\_ pin is controlled only during the

step-up converter's on-time. During the converter's off-time, the current sources are turned off. The output voltage does not discharge and stays high. Each FB\_ pin can withstand 28V, which is the pin's maximum rated voltage.

Table 2 summarizes the characteristics of both analog and digital dimming methods.

A PLL translates the duty cycle of the BRT input into a reference for the MAX8790A's current sources. A resistor from the FSET pin to ground controls the PLL's free-running frequency:

$$f_{PLL} = \frac{1}{10 \times R_{FSET} \times 800pF}$$

The PLL's loop filter bandwidth is set with a capacitor from the CPLL pin to ground. This filter integrates the phase difference between the BRT input signal and the PLL oscillator. The filter bandwidth determines the PLL's dynamic response to frequency changes in the BRT signal. For most applications, a 0.1µF capacitor is adequate for oscillator frequencies in the  $166Hz < f_{PLL} < 500Hz$  range. The PLL frequency capture window is  $0.6 \times f_{PLL}$  to  $f_{PLL}$ .

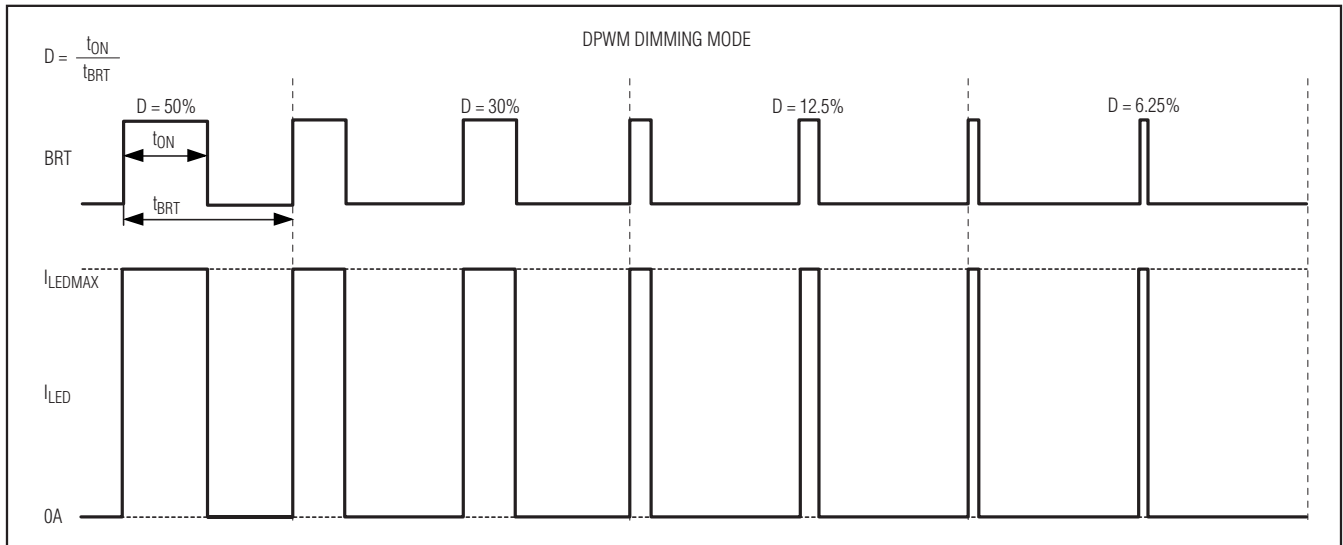

Figure 5. LED Current Control Using DPWM Dimming Mode

**Table 2. Dimming Mode**

MODE	ENA	PLL FREQUENCY	CPLL	DESCRIPTION
Analog + DPWM	> 2.1V	$250k\Omega < R_{FSET} < 754k\Omega$	0.1µF	Analog dimming from 100% to 12.5% brightness. From 12.5% to 1% brightness, DPWM dimming is employed. BRT frequency range is 100Hz to 500Hz.
Direct DPWM	< 0.8V	$V_{FSET} > V_{CC} - 0.4V$ , disables PLL	OPEN	Direct dimming by BRT signal. BRT frequency can be 100Hz to 2kHz; 50µs minimum BRT on-time limits the minimum brightness.



# Six-String White LED Driver with Active Current Balancing for LCD Panel Applications

The PLL is disabled in DPWM mode; consequently, the BRT frequency is not limited by  $f_{PLL}$ . The maximum BRT frequency is determined by the minimum BRT on-time of 50 $\mu$ s and the minimum acceptable dimming factor. If a 1% dimming factor is needed, the maximum BRT frequency is 200Hz. If a 10% dimming factor is acceptable, the maximum BRT frequency is 2kHz.

In analog dimming mode, load-current transients can occur when the BRT frequency abruptly changes on the fly. Large regulation transients induce a flash on the LED load that is observable with the naked eye and should therefore be avoided. Such annoying flashes can be eliminated by dynamically changing the ENA pin setting. When a capacitor is connected to the CPLL pin and the ENA pin is grounded, the PLL continues to run but does not affect the dimming. When fast PLL lockup transitions are required, the ENA pin can be momentarily pulled to

ground; after the PLL is locked up, ENA can be pulled high to reenable PLL in dimming control.

## Thermal Shutdown

The MAX8790A includes a thermal-protection circuit. When the local IC temperature exceeds +170°C (typ), the controller and current sources shut down and do not restart until the die temperature drops by 15°C.

## Design Procedure

All MAX8790A designs should be prototyped and tested prior to production. Table 3 provides a list of power components for the typical applications circuit. Table 4 lists component suppliers. External component value choice is primarily dictated by the output voltage and the maximum load current, as well as maximum and minimum input voltages. Begin by selecting an inductor value. Once L is known, choose the diode and capacitors.

**Table 3. Component List**

CIRCUIT	FIGURE 1	FIGURE 1	FIGURE 1	FIGURE 3
Switching Frequency	1MHz	750kHz	500kHz	750kHz
White LED	3.2V (typ), 3.5V (max) at 20mA Nichia NSSW008C	3.2V (typ), 3.5V (max) at 20mA Nichia NSSW008C	3.2V (typ), 3.5V (max) at 20mA Nichia NSSW008C	3.2V (typ), 3.5V (max) at 20mA Nichia NSSW008C
Number of White LEDs	6 series x 6 parallel, 20mA (max)	8 series x 6 parallel, 20mA (max)	10 series x 6 parallel, 25mA (max)	6 series x 6 parallel, 20mA (max)
Input Voltage	4.5V to 5.5V, $V_{CC} = IN$	7V to 21V	7V to 21V	2.8V to 5.5V, $V_{CC} = 5V$
Inductor L1	2.2 $\mu$ H, 2.5A power inductor Sumida CDRH5D16-2R2	4.7 $\mu$ H, 2.05A power inductor Sumida CDRH5D16-4R7	4.7 $\mu$ H, 3.6A power inductor Sumida CDRH8D28-4R7	0.9 $\mu$ H, 4.7A power inductor Sumida CDRH5D16-0R9
Input Capacitors	10 $\mu$ F $\pm$ 10%, 10V X5R ceramic capacitor (1206) Murata GRM31MR61A106K	10 $\mu$ F $\pm$ 10%, 25V X5R ceramic capacitor (1206) Murata GRM31CR61E106KA	10 $\mu$ F $\pm$ 10%, 25V X5R ceramic capacitor (1206) Murata GRM31CR61E106KA	10 $\mu$ F $\pm$ 10%, 10V X5R ceramic capacitor (1206) Murata GRM31MR61A106K
C <sub>OUT</sub> Output Capacitor	2.2 $\mu$ F $\pm$ 10%, 50V X7R ceramic capacitor (1x) Murata GRM31CR71H225K	2.2 $\mu$ F $\pm$ 10%, 50V X7R ceramic capacitor (1206) (1x) Murata GRM31CR71H225K	4.7 $\mu$ F $\pm$ 10%, 50V X7R ceramic capacitor (1210) (1x) Murata GRM32ER71H475K	2.2 $\mu$ F $\pm$ 10%, 50V X7R ceramic capacitor (1x) Murata GRM31CR71H225K
MOSFET N1	30V, 3A n-channel MOSFET (6-pin SC70) Vishay Si1402DH	60V, 2.8A n-channel MOSFET (6-pin TSOP) Fairchild Semiconductor FDC5612 Sanyo Semiconductor CPH6424	60V, 6A n-channel MOSFET (PowerPAK 1212-8) Vishay Si7308DN	30V, 4.9A n-channel MOSFET (6-pin TSOP) Vishay Si3456BDV
Diode Rectifier D1	2A, 30V Schottky diode Nihon EC21QS03L	2A, 40V Schottky diode Toshiba CMS11 Nihon EC21QS04	3A, 60V Schottky diode Nihon EC31QS06	3A, 30V Schottky diode Nihon EC31QS03L
Sense Resistor	50m $\Omega$ $\pm$ 1%, 1/2W IRC LRC-LRF-1206LF-01-R050-F	56m $\Omega$ $\pm$ 1%, 1/2W IRC LRC-LRF-1206LF-01-R056-F	40m $\Omega$ $\pm$ 1%, 1/2W IRC LRC-LRF-1206LF-01-R040-F	30m $\Omega$ $\pm$ 1%, 1/2W IRC LRC-LRF-1206LF-01-R030-F

# Six-String White LED Driver with Active Current Balancing for LCD Panel Applications

Table 4. Component Suppliers

SUPPLIER	PHONE	WEBSITE
Murata	770-436-1300	www.murata.com
Nichia	248-352-6575	www.nichia.com
Sumida	847-545-6700	www.sumida.com
Toshiba	949-455-2000	www.toshiba.com/taec
Vishay	203-268-6261	www.vishay.com

### Inductor Selection

The inductance, peak current rating, series resistance, and physical size should all be considered when selecting an inductor. These factors affect the converter's operating mode, efficiency, maximum output load capability, transient response time, output voltage ripple, and cost.

The maximum output current, input voltage, output voltage, and switching frequency determine the inductor value. Very high inductance minimizes the current ripple, and therefore reduces the peak current, which decreases core losses in the inductor and I<sup>2</sup>R losses in the entire power path. However, large inductor values also require more energy storage and more turns of wire, which increases physical size and I<sup>2</sup>R copper losses in the inductor. Low inductor values decrease the physical size, but increase the current ripple and peak current. Finding the best inductor involves the compromises among circuit efficiency, inductor size, and cost.

When choosing an inductor, the first step is to determine the operating mode: continuous conduction mode (CCM) or discontinuous conduction mode (DCM). The MAX8790A has a fixed internal slope compensation, which requires a minimum inductor value. When CCM mode is chosen, the ripple current and the peak current of the inductor can be minimized. If a small-size inductor is required, DCM mode can be chosen. In DCM mode, the inductor value and size can be minimized but the inductor ripple current and peak current are higher than those in CCM. The controller can be stable, independent of the internal slope compensation mode, but there is a maximum inductor value requirement to ensure the DCM operating mode.

The equations used here include a constant LIR, which is the ratio of the inductor peak-to-peak ripple current to the average DC inductor current at the full-load current. The controller operates in DCM mode when LIR is higher than 2.0, and it switches to CCM mode when LIR is lower than 2.0. The best trade-off between inductor size and converter efficiency for step-up regulators generally has an LIR between 0.3 and 0.5. However, depending on the AC characteristics of the inductor

core material and ratio of inductor resistance to other power-path resistances, the best LIR can shift up or down. If the inductor resistance is relatively high, more ripple can be accepted to reduce the number of required turns and increase the wire diameter. If the inductor resistance is relatively low, increasing inductance to lower the peak current can reduce losses throughout the power path. If extremely thin high-resistance inductors are used, as is common for LCD panel applications, LIR higher than 2.0 can be chosen for DCM operating mode.

Once a physical inductor is chosen, higher and lower values of the inductor should be evaluated for efficiency improvements in typical operating regions. The detail design procedure can be described as follows:

Calculate the approximate inductor value using the typical input voltage (V<sub>IN</sub>), the maximum output current (I<sub>OUT(MAX)</sub>), the expected efficiency (η<sub>TYP</sub>) taken from an appropriate curve in the *Typical Operating Characteristics*, and an estimate of LIR based on the above discussion:

$$L = \left( \frac{V_{IN\_MIN}}{V_{OUT}} \right)^2 \left( \frac{V_{OUT} - V_{IN\_MIN}}{I_{OUT(MAX)} \times f_{OSC}} \right) \left( \frac{\eta_{TYP}}{LIR} \right)$$

The MAX8790A has a minimum inductor value limitation for stable operation in CCM mode at low input voltage because of the internal fixed slope compensation. The minimum inductor value for stability is calculated by the following equation:

$$L_{CCM(MIN)} = \frac{(V_{OUT(MAX)} + V_{DIODE} - 2 \times V_{IN(MIN)}) \times R_S}{51mV \times f_{OSC(MIN)}}$$

where 51mV is a scale factor based on slope compensation, and R<sub>S</sub> is the current-sense resistor. To determine the minimum inductor value, the R<sub>S</sub> can be temporarily calculated using the following equation:

$$R_{S\_TMP} = \frac{100mV}{1.2 \times I_{IN(DC,MAX)}}$$

where 100mV is the current-limit sense voltage.

# Six-String White LED Driver with Active Current Balancing for LCD Panel Applications

The minimum inductor value should be recalculated after the  $R_S$  is determined (see the *Sense-Resistor Selection* section).

Choose an available inductor value from an appropriate inductor family. Calculate the maximum DC input current at the minimum input voltage  $V_{IN(MIN)}$ , using conservation of energy and the expected efficiency at that operating point ( $\eta_{MIN}$ ) taken from an appropriate curve in the *Typical Operating Characteristics*:

$$I_{IN(DC,MAX)} = \frac{I_{OUT(MAX)} \times V_{OUT}}{V_{IN(MIN)} \times \eta_{MIN}}$$

Calculate the ripple current at that operating point and the peak current required for the inductor:

$$I_{RIPPLE} = \frac{V_{IN(MIN)} \times (V_{OUT(MAX)} - V_{IN(MIN)})}{L \times V_{OUT(MAX)} \times f_{OSC}}$$

$$I_{PEAK} = I_{IN(DC,MAX)} + \frac{I_{RIPPLE}}{2}$$

When DCM operating mode is chosen to minimize the inductor value, the calculations are different from that in the above CCM mode. The maximum inductor value for DCM mode is calculated by the following equation:

$$L_{DCM(MAX)} = \left( 1 - \frac{V_{IN(MIN)}}{V_{OUT(MAX)} + V_{DIODE}} \right) \times \frac{V_{IN(MIN)}^2 \times \eta}{2 \times f_{OSC(MAX)} \times V_{OUT(MAX)} \times I_{OUT(MAX)}}$$

The peak inductor current in DCM mode is calculated using the following equation:

$$I_{PEAK} = \sqrt{\frac{I_{OUT(max)} \times 2 \times V_{OUT(MAX)} \times (V_{OUT(MAX)} + V_{DIODE} - V_{IN(MIN)})}{L \times f_{OSC(MIN)} \times \eta \times (V_{OUT(MAX)} + V_{DIODE})}}$$

The inductor's saturation current rating should exceed  $I_{PEAK}$  and the inductor's DC current rating should exceed  $I_{IN(DC,MAX)}$ . For good efficiency, choose an inductor with less than  $0.1\Omega$  series resistance.

Considering the typical operating circuit, the maximum load current ( $I_{OUT(MAX)}$ ) is 120mA with a 28.72V output and a minimal input voltage of 7V. Choosing a DCM operating mode and estimating efficiency of 90% at this operating point:

$$L_{DCM(MAX)} = \left( 1 - \frac{7V}{28.72V + 0.4V} \right) \times \frac{(7V)^2 \times 0.9}{2 \times 0.825MHz \times 28.72V \times 120mA} = 5.8\mu H$$

An inductance less than  $L_{DCM(MAX)}$  is required, so a 4.7 $\mu$ H inductor is chosen. The peak inductor current at minimum input voltage is calculated as follows:

$$I_{PEAK} = \sqrt{\frac{120mA \times 2 \times 28.72V \times (28.72V + 0.4V - 7V)}{4.7\mu H \times 0.675MHz \times 0.9 \times (28.72V + 0.4V)}} = 1.35A$$

## Sense-Resistor Selection

The detected signal is fed into the step-up converter control compensation loop through the CS pin.

The MAX8790A's current-mode step-up converter senses the switch current from CS to GND with an external resistor,  $R_S$ . The current-limit sense voltage is a fixed 100mV. The required resistance is calculated based upon the peak inductor current at the end of the switch on-time:

$$R_S < \frac{V_{CS\_EC} + 25.6mV \times (0.75 - D_{MAX})}{I_{PEAK}}$$

where 25.6mV is a scale factor from slope compensation,  $V_{CS\_EC}$  is the current-sense voltage listed in the *Electrical Characteristics* table (85mV), and the  $D_{MAX}$  is the maximum duty cycle at minimum input voltage and maximum output voltage. In DCM operating mode, it is calculated by the following equation:

$$D_{MAX} = \frac{L \times I_{LIM} \times f_{OSC}}{V_{IN(MIN)}}$$

For the typical operating circuit as Figure 1:

$$D_{MAX} = \frac{4.7\mu H \times 1.35A \times 0.75MHz}{7V} = 0.68$$

$$R_S < \frac{85mV + 25.6mV \times (0.75 - 0.68)}{1.35A} = 64m\Omega$$

Again,  $R_S$  is calculated as a maximum, so a 56m $\Omega$  current-sense resistor is chosen.

# Six-String White LED Driver with Active Current Balancing for LCD Panel Applications

## Output Capacitor Selection

The total output voltage ripple has two components: the capacitive ripple caused by the charging and discharging on the output capacitor, and the ohmic ripple due to the capacitor's equivalent series resistance (ESR):

$$V_{\text{RIPPLE}} = V_{\text{RIPPLE(C)}} + V_{\text{RIPPLE(ESR)}}$$

$$V_{\text{RIPPLE(C)}} \approx \frac{I_{\text{OUT(MAX)}}}{C_{\text{OUT}}} \left( \frac{V_{\text{OUT(MAX)}} - V_{\text{IN(MIN)}}}{V_{\text{OUT(MAX)}} f_{\text{OSC}}} \right)$$

and:

$$V_{\text{RIPPLE(ESR)}} \approx I_{\text{PEAK}} R_{\text{ESR(COUT)}}$$

where  $I_{\text{PEAK}}$  is the peak inductor current (see the *Inductor Selection* section).

The output voltage-ripple voltage should be low enough for the FB\_ current-source regulation. The ripple voltage should be less than 200mV<sub>p-p</sub>. For ceramic capacitors, the output-voltage ripple is typically dominated by  $V_{\text{RIPPLE(C)}}$ . The voltage rating and temperature characteristics of the output capacitor must also be considered.

## External MOSFET Selection

The MAX8790A's step-up converter uses an external MOSFET to enable applications with scalable output voltage and output power. The boost switching architecture is simple and ensures that the controller is never exposed to high voltage. Only the external MOSFET, diode, and inductor are exposed to the output voltage plus one Schottky diode forward voltage:

$$V_{\text{BV}} = N \times V_{\text{F\_LED}} + V_{\text{F\_SCHOTTKY}} + V_{\text{FB\_}}$$

The MOSFET's breakdown ratings should be higher than  $V_{\text{BV}}$  with sufficient margin to ensure long-term reliability. A conservative rule of thumb, a minimum 30% margin would be recommended for MOSFET breakdown voltage. The external MOSFET should have a current rating of no less than the  $I_{\text{PEAK}}$  derived from the *Inductor Selection* section. To improve efficiency, choose a MOSFET with low  $R_{\text{DS(ON)}}$ . The MAX8790A's gate-drive linear regulator can provide 10mA. Select the external MOSFET with a total gate charge so the average current to drive the MOSFET at maximum switching frequency is less than 10mA:

$$Q_{\text{g(MAX)}} \times f_{\text{OSC}} < 10\text{mA}$$

For example, the Si3458DV is specified with 16nC of max total gate charge at  $V_{\text{g}} = 10\text{V}$ . For 5V of gate drive, the required gate charge is 8nC, which equates to 8mA at 1MHz.

The MOSFET conduction loss or resistive loss is caused by the MOSFET's on-resistance ( $R_{\text{DS(ON)}}$ ). This power loss can be estimated as:

$$P_{\text{DRES(MAX)}} = \frac{R_{\text{DS(ON)}} \times L \times f_{\text{OSC}} \times I_{\text{PEAK}}^3}{3 \times V_{\text{IN(MIN)}}$$

For the above Si3458DV, the estimated conduction loss is:

$$P_{\text{DRES(MAX)}} = \frac{0.1\Omega \times 4.7\mu\text{H} \times 750\text{kHz} \times 1.35\text{A}^3}{3 \times 7\text{V}} = 0.04\text{W}$$

The approximate maximum switching loss can be calculated as:

$$P_{\text{DSW(MAX)}} = \frac{t_{\text{turn-off}} \times I_{\text{PEAK}} \times V_{\text{OUT}} \times f_{\text{OSC}}}{2}$$

For the above Si3458DV, the approximate switching loss is:

$$P_{\text{DSW(MAX)}} = \frac{10\text{ns} \times 1.35\text{A} \times 28.72\text{V} \times 750\text{kHz}}{2} = 0.145\text{W}$$

## Rectifier Diode Selection

The MAX8790A's high switching frequency demands a high-speed rectifier. Schottky diodes are recommended for most applications because of their fast recovery time and low forward voltage. The diode should be rated to handle the output voltage and the peak switch current. Make sure that the diode's peak current rating is at least  $I_{\text{PEAK}}$  calculated in the *Inductor Selection* section and that its breakdown voltage exceeds the output voltage.

## Setting the Overvoltage Protection Limit

The OV protection circuit should ensure the circuit safe operation; therefore, the controller should limit the output voltage within the ratings of all MOSFET, diode, and output capacitor components, while providing sufficient output voltage for LED current regulation. The OV pin is connected to the center tap of a resistive voltage-divider ( $R_1$  and  $R_2$  in Figure 1) from the high-voltage output. When the controller detects the OV pin voltage reaching the threshold  $V_{\text{OV\_TH}}$ , typically 1.23V, OV protection is activated. Hence, the step-up converter output overvoltage protection point is:

$$V_{\text{OUT(OVP)}} = V_{\text{OV\_TH}} \times \left(1 + \frac{R_1}{R_2}\right)$$

In Figure 1, the output OVP voltage is set to:

$$V_{\text{OUT(OVP)}} = 1.23\text{V} \times \left(1 + \frac{1\text{M}\Omega}{37.4\text{k}\Omega}\right) = 34.1\text{V}$$

# Six-String White LED Driver with Active Current Balancing for LCD Panel Applications

## Input Capacitor Selection

The input capacitor ( $C_{IN}$ ) filters the current peaks drawn from the input supply and reduces noise injection into the IC. A 10 $\mu$ F ceramic capacitor is used in the typical operating circuit (Figure 1) because of the high source impedance seen in typical lab setups. Actual applications usually have much lower source impedance since the step-up regulator often runs directly from the output of another regulated supply. In some applications,  $C_{IN}$  can be reduced below the values used in the typical operating circuit. Ensure a low noise supply at IN by using adequate  $C_{IN}$ . Alternatively, greater voltage variation can be tolerated on  $C_{IN}$  if IN is decoupled from  $C_{IN}$  using an RC lowpass filter.

Select  $C_{IN}$ 's RMS ripple current rating to ensure that its thermal rise is less than approximately 10°C:

$$I_{RMS} = \frac{dI_L}{2 \times \sqrt{3}}$$

## LED Selection and Bias

The series/parallel configuration of the LED load and the full-scale bias current have a significant effect on regulator performance. LED characteristics vary significantly from manufacturer to manufacturer. Consult the respective LED data sheets to determine the range of output voltages for a given brightness and LED current. In general, brightness increases as a function of bias current. This suggests that the number of LEDs could be decreased if higher bias current is chosen; however, high current increases LED temperature and reduces operating life. Improvements in LED technology are resulting in devices with lower forward voltage while increasing the bias current and light output.

LED manufacturers specify LED color at a given LED current. With lower LED current, the color of the emitted light tends to shift toward the blue range of the spectrum. A blue bias is often acceptable for business applications but not for high-image-quality applications such as DVD players. Direct DPWM dimming is a viable solution for reducing power dissipation while maintaining LED color integrity. Careful attention should be paid to switching noise to avoid other display quality problems.

Using fewer LEDs in a string improves step-up converter efficiency, and lowers breakdown voltage requirements of the external MOSFET and diode. The minimum number of LEDs in series should always be greater than the maximum input voltage. If the diode voltage drop is lower than the maximum input voltage, the voltage drop across the current-sense inputs (FB\_) increases and causes excess heating in the IC. Between 8 and 12 LEDs in series is ideal for input voltages up to 20V.

## Applications Information

### LED $V_{FB}$ Variation

The MAX8790A has accurate ( $\pm 1.5\%$ ) matching for each current source. However, the forward voltage of each white LED can vary up to  $\pm 5\%$  from part to part. The accumulated voltage difference in each string equates to additional power loss within the IC. For the best efficiency, the voltage difference between strings should be minimized. The difference between lowest voltage string and highest voltage string should be less than 4.5V. Otherwise, the internal LED short-circuit protection shuts the part off.

### Choosing the Appropriate Dimming Mode

Analog dimming mode allows lower peak LED current and results in higher converter efficiency and lower noise compared to direct DPWM mode. Unfortunately, the LED color spectrum can shift as a function of DC current so DPWM mode is often used to achieve more consistent display characteristics. (See the LED manufacturer's data sheet to determine the extent of the color shift.) When the MAX8790A is configured with an FSET resistor and CPLL capacitor, the ENA signal can toggle between modes on the fly. Care should be exercised when switching between modes to prevent the current from becoming unstable during the PLL lock-in time. To avoid such problems, force the controller into DPWM mode between transitions.

### LCD Panel Capacitance

Some LCD panels include a capacitor in parallel with LED string to improve ESD immunity. The MAX8790A can start up without a problem for string capacitance up to 0.27 $\mu$ F.



# Six-String White LED Driver with Active Current Balancing for LCD Panel Applications

## PCB Layout Guidelines

Careful PCB layout is important for proper operation. Use the following guidelines for good PCB layout:

- 1) Minimize the area of the high current-switching loop of the rectifier diode, external MOSFET, sense resistor, and output capacitor to avoid excessive switching noise. Use wide and short traces for the gate-drive loop from the EXT pin, to the MOSFET gate, and through the current-sense resistor, then returning to the IC GND pin.
- 2) Connect high-current input and output components with short and wide connections. The high-current input loop goes from the positive terminal of the input capacitor to the inductor, to the external MOSFET, then to the current-sense resistor, and to the input capacitor's negative terminal. The high-current output loop is from the positive terminal of the input capacitor to the inductor, to the rectifier diode, to the positive terminal of the output capacitors, reconnecting between the output capacitor and input capacitor ground terminals. Avoid using vias in the high-current paths. If vias are unavoidable, use multiple vias in parallel to reduce resistance and inductance.
- 3) Create a ground island (PGND) consisting of the input and output capacitor ground and negative terminal of the current-sense resistor. Connect all these together with short, wide traces or a small ground plane. Maximizing the width of the power ground traces improves efficiency and reduces output-voltage ripple and noise spikes. Create an analog ground island (AGND) consisting of the overvoltage detection-divider ground connection, the ISET and FSET resistor connections, CCV and CPLL capacitor connections, and the device's exposed backside pad. Connect the AGND and PGND islands by connecting the GND pins directly to the exposed backside pad. Make no other connections between these separate ground planes.
- 4) Place the overvoltage detection-divider resistors as close to the OV pin as possible. The divider's center trace should be kept short. Placing the resistors far away causes the sensing trace to become antennas that can pick up switching noise. Avoid running the sensing traces near LX.
- 5) Place the IN pin bypass capacitor as close to the device as possible. The ground connection of the IN bypass capacitor should be connected directly to GND pins with a wide trace.
- 6) Minimize the size of the LX node while keeping it wide and short. Keep the LX node away from the feedback node and ground. If possible, avoid running the LX node from one side of the PCB to the other. Use DC traces as shields, if necessary.
- 7) Refer to the MAX8790A evaluation kit for an example of proper board layout.

## Pin Configuration

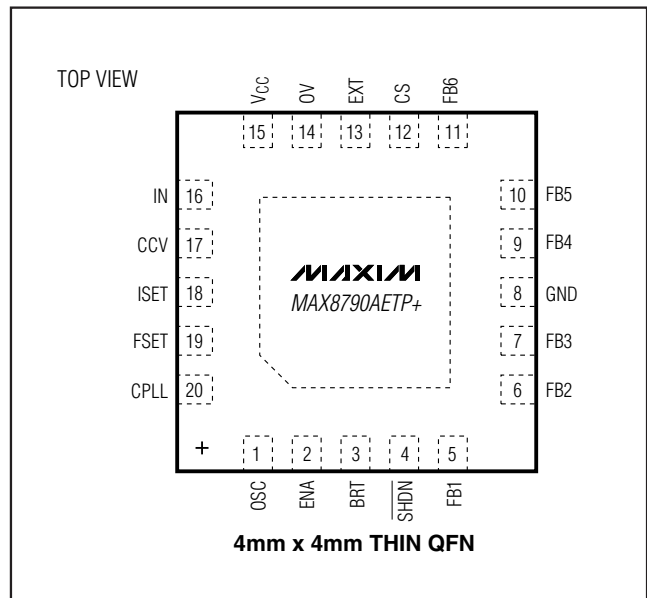

## Chip Information

TRANSISTOR COUNT: 12,042  
 PROCESS: BiCMOS

# Six-String White LED Driver with Active Current Balancing for LCD Panel Applications

## Package Information

(The package drawing(s) in this data sheet may not reflect the most current specifications. For the latest package outline information go to [www.maxim-ic.com/packages](http://www.maxim-ic.com/packages).)

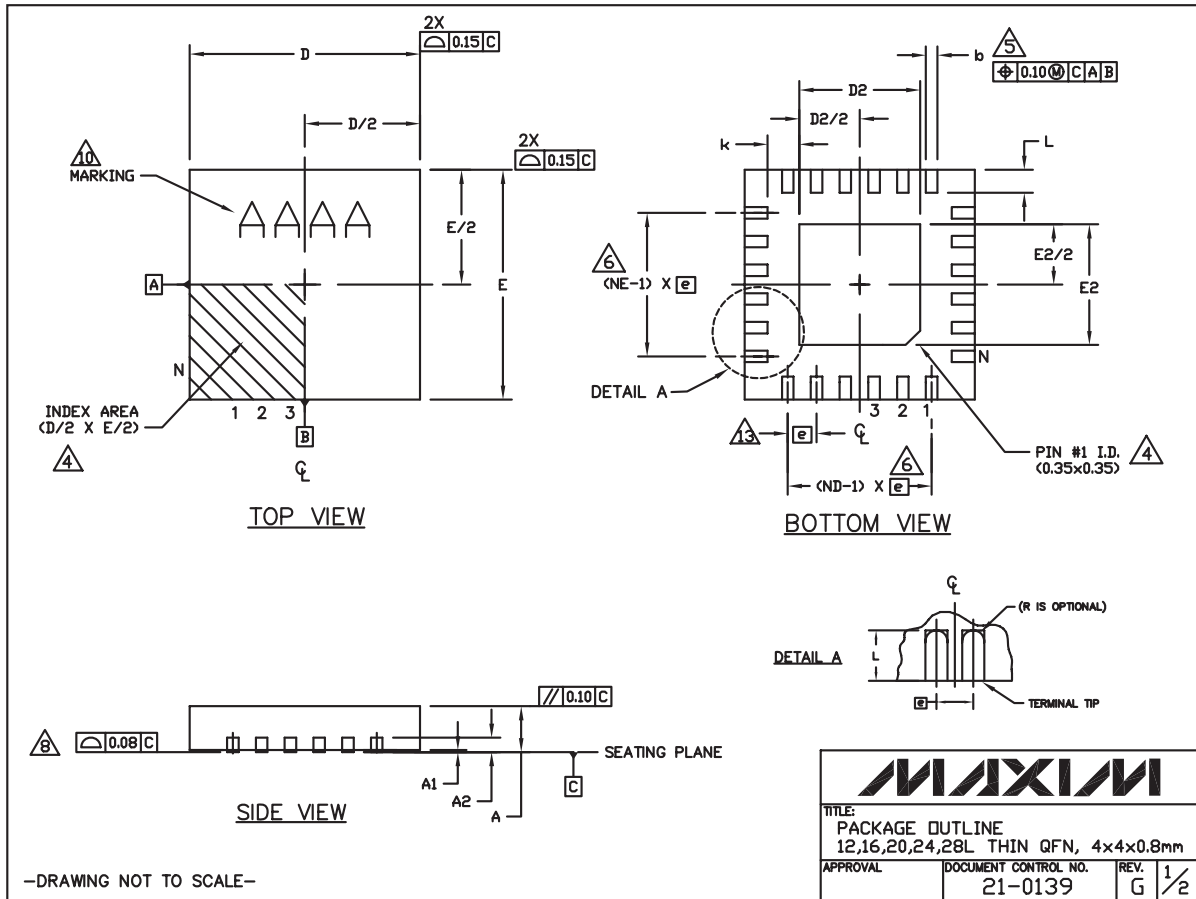

24L QFN THINLEPS

-DRAWING NOT TO SCALE-



# Six-String White LED Driver with Active Current Balancing for LCD Panel Applications

## Package Information (continued)

(The package drawing(s) in this data sheet may not reflect the most current specifications. For the latest package outline information go to [www.maxim-ic.com/packages](http://www.maxim-ic.com/packages).)

MAX8790A

COMMON DIMENSIONS															
PKG	12L 4x4			16L 4x4			20L 4x4			24L 4x4			28L 4x4		
REF.	MIN.	NDM.	MAX.	MIN.	NDM.	MAX.	MIN.	NDM.	MAX.	MIN.	NDM.	MAX.	MIN.	NDM.	MAX.
A	0.70	0.75	0.80	0.70	0.75	0.80	0.70	0.75	0.80	0.70	0.75	0.80	0.70	0.75	0.80
A1	0.0	0.02	0.05	0.0	0.02	0.05	0.0	0.02	0.05	0.0	0.02	0.05	0.0	0.02	0.05
A2	0.20 REF.			0.20 REF.			0.20 REF.			0.20 REF.			0.20 REF.		
b	0.25	0.30	0.35	0.25	0.30	0.35	0.20	0.25	0.30	0.18	0.23	0.30	0.15	0.20	0.25
D	3.90	4.00	4.10	3.90	4.00	4.10	3.90	4.00	4.10	3.90	4.00	4.10	3.90	4.00	4.10
E	3.90	4.00	4.10	3.90	4.00	4.10	3.90	4.00	4.10	3.90	4.00	4.10	3.90	4.00	4.10
e	0.80 BSC.			0.65 BSC.			0.50 BSC.			0.50 BSC.			0.40 BSC.		
k	0.25	-	-	0.25	-	-	0.25	-	-	0.25	-	-	0.25	-	-
L	0.45	0.55	0.65	0.45	0.55	0.65	0.45	0.55	0.65	0.30	0.40	0.50	0.30	0.40	0.50
N	12			16			20			24			28		
ND	3			4			5			6			7		
NE	3			4			5			6			7		
Jedec Var.	VGGB			WGGC			WGGD-1			WGGD-2			WGGE		

EXPOSED PAD VARIATIONS						
PKG. CODES	D2			E2		
	MIN.	NDM.	MAX.	MIN.	NDM.	MAX.
T1244-3	1.95	2.10	2.25	1.95	2.10	2.25
T1244-4	1.95	2.10	2.25	1.95	2.10	2.25
T1644-3	1.95	2.10	2.25	1.95	2.10	2.25
T1644-4	1.95	2.10	2.25	1.95	2.10	2.25
T2044-2	1.95	2.10	2.25	1.95	2.10	2.25
T2044-3	1.95	2.10	2.25	1.95	2.10	2.25
T2444-2	1.95	2.10	2.25	1.95	2.10	2.25
T2444-3	2.45	2.60	2.63	2.45	2.60	2.63
T2444-4	2.45	2.60	2.63	2.45	2.60	2.63
T2844-1	2.50	2.60	2.70	2.50	2.60	2.70

NOTES:

- DIMENSIONING & TOLERANCING CONFORM TO ASME Y14.5M-1994.
- ALL DIMENSIONS ARE IN MILLIMETERS. ANGLES ARE IN DEGREES.
- N IS THE TOTAL NUMBER OF TERMINALS.
- THE TERMINAL #1 IDENTIFIER AND TERMINAL NUMBERING CONVENTION SHALL CONFORM TO JESD 95-1 SPP-012. DETAILS OF TERMINAL #1 IDENTIFIER ARE OPTIONAL, BUT MUST BE LOCATED WITHIN THE ZONE INDICATED. THE TERMINAL #1 IDENTIFIER MAY BE EITHER A MOLD OR MARKED FEATURE.
- DIMENSION b APPLIES TO METALLIZED TERMINAL AND IS MEASURED BETWEEN 0.25mm AND 0.30mm FROM TERMINAL TIP.
- ND AND NE REFER TO THE NUMBER OF TERMINALS ON EACH D AND E SIDE RESPECTIVELY.
- DEPOPULATION IS POSSIBLE IN A SYMMETRICAL FASHION.
- COPLANARITY APPLIES TO THE EXPOSED HEAT SINK SLUG AS WELL AS THE TERMINALS.
- DRAWING CONFORMS TO JEDEC MO220, EXCEPT FOR T2444-3, T2444-4 AND T2844-1.
- MARKING IS FOR PACKAGE ORIENTATION REFERENCE ONLY.
- COPLANARITY SHALL NOT EXCEED 0.08mm.
- WARPAGE SHALL NOT EXCEED 0.10mm.
- LEAD CENTERLINES TO BE AT TRUE POSITION AS DEFINED BY BASIC DIMENSION 'e', ±0.05.
- NUMBER OF LEADS SHOWN ARE FOR REFERENCE ONLY.
- ALL DIMENSIONS ARE THE SAME FOR LEADED (-) & PbfREE (+) PACKAGE CODES.

-DRAWING NOT TO SCALE-

			
TITLE: PACKAGE OUTLINE 12,16,20,24,28L THIN QFN, 4x4x0.8mm			
APPROVAL	DOCUMENT CONTROL NO.	REV.	2/2
	21-0139	G	

## Revision History

Pages changed at Rev 1: All A added to all pages.

Maxim cannot assume responsibility for use of any circuitry other than circuitry entirely embodied in a Maxim product. No circuit patent licenses are implied. Maxim reserves the right to change the circuitry and specifications without notice at any time.

Maxim Integrated Products, 120 San Gabriel Drive, Sunnyvale, CA 94086 408-737-7600 23