



## LRI64

Memory TAG IC at 13.56 MHz, with 64-bit Unique ID and WORM user area, ISO15693 and ISO18000-3 Mode 1 compliant

### Features

- ISO 15693 Compliant
- ISO 18000-3 Mode 1 compliant
- 13.56 MHz  $\pm$ 7 kHz carrier frequency
- Supported data transfer to the LRI64:  
10% ASK modulation using "1-out-of-4" pulse position coding (26 Kbit/s)
- Supported data transfer from the LRI64:  
Load modulation using Manchester coding with 423 kHz single sub-carrier in fast data rate (26 Kbit/s)
- Internal tuning capacitor (21 pF, 28.5 pF, 97 pF)
- 7 x 8 bits WORM user area
- 64-bit Unique Identifier (UID)
- Read Block and Write Block Commands (8-bit blocks)
- 7 ms Programming time (typical)
- More than 40-year data retention
- Electrical Article Surveillance capable (software controlled)
- Packages
  - ECOPACK® (RoHS compliant)

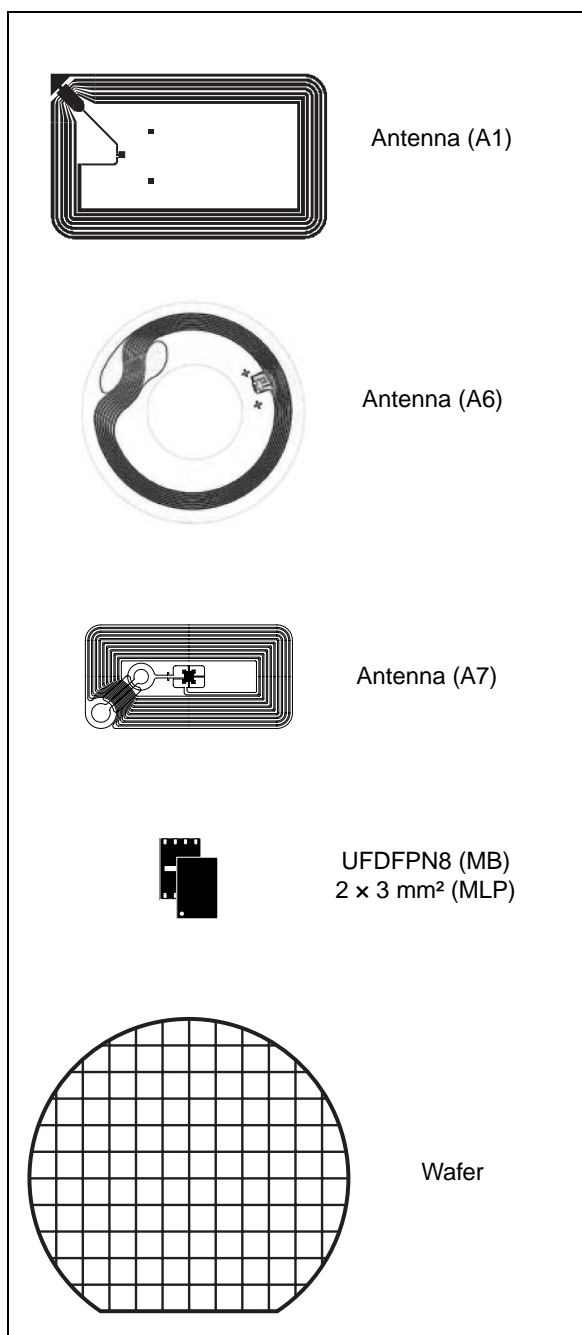

# Contents

- 1 Description . . . . . 7**
  - 1.1 Memory mapping . . . . . 8
- 2 Signal description . . . . . 9**
- 3 Commands . . . . . 9**
  - 3.1 Inventory . . . . . 9
  - 3.2 Stay Quiet . . . . . 9
  - 3.3 Read Block . . . . . 9
  - 3.4 Write Block . . . . . 9
  - 3.5 Get\_System\_Info . . . . . 9
  - 3.6 Initial Dialogue for Vicinity Cards . . . . . 9
- 4 Power transfer . . . . . 10**
  - 4.1 Frequency . . . . . 10
  - 4.2 Operating field . . . . . 10
- 5 Communication signal from VCD to LRI64 . . . . . 11**
- 6 Data rate and data coding . . . . . 12**
- 7 VCD to LRI64 frames . . . . . 13**
- 8 Communications signal from LRI64 to VCD . . . . . 14**
  - 8.1 Load modulation . . . . . 14
  - 8.2 Subcarrier . . . . . 14
  - 8.3 Data rate . . . . . 14
  - 8.4 Bit representation and coding using one subcarrier, at the high data rate 14
    - 8.4.1 Logic 0 . . . . . 14
    - 8.4.2 Logic 1 . . . . . 15
- 9 LRI64 to VCD frames . . . . . 16**
  - 9.1 LRI64 SOF . . . . . 16

---

9.2	LRI64 EOF .....	16
<b>10</b>	<b>Special fields .....</b>	<b>17</b>
10.1	Unique Identifier (UID) .....	17
10.2	Application Family Identifier (AFI) .....	18
10.3	Data Storage Format Identifier (DSFID) .....	18
10.4	Cyclic Redundancy Code (CRC) .....	18
<b>11</b>	<b>LRI64 protocol description .....</b>	<b>19</b>
<b>12</b>	<b>LRI64 states .....</b>	<b>21</b>
12.1	Power-off state .....	21
12.2	Ready state .....	21
12.3	Quiet state .....	21
<b>13</b>	<b>Modes .....</b>	<b>22</b>
13.1	Addressed mode .....	22
13.2	Non-addressed mode (General Request) .....	22
<b>14</b>	<b>Flags and error codes .....</b>	<b>23</b>
14.1	Request flags .....	23
14.2	Response flags .....	24
14.3	Response error code .....	24
<b>15</b>	<b>Anti-collision .....</b>	<b>25</b>
15.1	Request flags .....	25
15.2	Mask length and mask value .....	25
15.3	Inventory responses .....	25
<b>16</b>	<b>Request processing by the LRI64 .....</b>	<b>27</b>
16.1	Explanation of the possible cases .....	28
<b>17</b>	<b>Timing definitions .....</b>	<b>30</b>
17.1	LRI64 response delay, t1 .....	30
17.2	VCD new request delay, t2 .....	30
17.3	VCD new request delay when there is no LRI64 response, t3 .....	31

---

<b>18</b>	<b>Command codes</b> .....	<b>32</b>
18.1	Inventory .....	32
18.2	Stay Quiet .....	33
18.3	Read Single Block .....	34
18.4	Write Single Block .....	35
18.5	Get System Info .....	37
<b>19</b>	<b>Maximum rating</b> .....	<b>39</b>
<b>20</b>	<b>DC and AC parameters</b> .....	<b>40</b>
<b>21</b>	<b>Package mechanical</b> .....	<b>42</b>
<b>22</b>	<b>Part numbering</b> .....	<b>46</b>
<b>Appendix A</b>	<b>algorithm for pulsed slots</b> .....	<b>47</b>
<b>Appendix B</b>	<b>C-example to calculate or check the CRC16</b>	
	<b>according to ISO/IEC 13239</b> .....	<b>48</b>
22.1	CRC calculation example .....	48
<b>Appendix C</b>	<b>Application family identifier (AFI) coding</b> .....	<b>50</b>
<b>Revision history</b>	.....	<b>51</b>

## List of tables

Table 1.	Signal names . . . . .	7
Table 2.	10% modulation parameters . . . . .	11
Table 3.	Request flags 1 to 4 . . . . .	23
Table 4.	Request flags 5 to 8 (when bit 3 = 0) . . . . .	23
Table 5.	Request flags 5 to 8 (when bit 3 = 1) . . . . .	24
Table 6.	Response flags 1 to 8 . . . . .	24
Table 7.	Response error code . . . . .	24
Table 8.	Timing values . . . . .	30
Table 9.	Command codes . . . . .	32
Table 10.	Block lock status . . . . .	34
Table 11.	Absolute maximum ratings . . . . .	39
Table 12.	Operating conditions . . . . .	40
Table 13.	DC characteristics . . . . .	40
Table 14.	AC characteristics . . . . .	41
Table 15.	A1 Antenna on tape mechanical data . . . . .	42
Table 16.	A6 Antenna on tape mechanical data . . . . .	43
Table 17.	A7 Antenna on tape mechanical data . . . . .	44
Table 18.	UFDFPN8 (MLP8), 8-lead Ultra thin Fine pitch Dual Flat Package No lead 2 × 3 mm, package mechanical data . . . . .	45
Table 19.	Ordering information scheme . . . . .	46
Table 20.	CRC definition . . . . .	48
Table 21.	AFI coding . . . . .	50
Table 22.	Document revision history . . . . .	51

## List of figures

Figure 1.	Logic diagram . . . . .	7
Figure 2.	MLP connections . . . . .	7
Figure 3.	LRI64 memory mapping . . . . .	8
Figure 4.	10% modulation waveform . . . . .	11
Figure 5.	“1-out-of-4” coding example . . . . .	11
Figure 6.	“1-out-of-4” coding mode . . . . .	12
Figure 7.	Request SOF, using the “1-out-of-4” data coding mode . . . . .	13
Figure 8.	Request EOF . . . . .	13
Figure 9.	Logic 0, high data rate . . . . .	14
Figure 10.	Logic 1, high data rate . . . . .	15
Figure 11.	Response SOF, using high data rate and one subcarrier . . . . .	16
Figure 12.	Response EOF, using high data rate and one subcarrier . . . . .	16
Figure 13.	UID format . . . . .	17
Figure 14.	Decision tree for AFI . . . . .	17
Figure 15.	CRC format . . . . .	18
Figure 16.	VCD request frame format . . . . .	19
Figure 17.	LRI64 response frame format . . . . .	20
Figure 18.	LRI64 protocol timing . . . . .	20
Figure 19.	LRI64 state transition diagram . . . . .	22
Figure 20.	Comparison between the Mask, Slot Number and UID . . . . .	26
Figure 21.	Description of a possible anti-collision sequence between LRI64 devices . . . . .	29
Figure 22.	Inventory, request frame format . . . . .	32
Figure 23.	Inventory, response frame format . . . . .	32
Figure 24.	Stay Quiet, request frame format . . . . .	33
Figure 25.	Stay Quiet frame exchange between VCD and LRI64 . . . . .	33
Figure 26.	Read Single Block, request frame format . . . . .	34
Figure 27.	Read Single Block, response frame format, when Error_Flag is not set . . . . .	34
Figure 28.	Read Single Block, response frame format, when Error_Flag is set . . . . .	34
Figure 29.	READ Single Block frame exchange between VCD and LRI64 . . . . .	35
Figure 30.	Write Single Block, request frame format . . . . .	35
Figure 31.	Write Single Block, response frame format, when Error_Flag is not set . . . . .	35
Figure 32.	Write Single Block, response frame format, when Error_Flag is set . . . . .	36
Figure 33.	Write Single Block frame exchange between VCD and LRI64 . . . . .	36
Figure 34.	Get System Info, request frame format . . . . .	37
Figure 35.	Get System Info, response frame format, when Error_Flag is not set . . . . .	37
Figure 36.	Get System Info, response frame format, when Error_Flag is set . . . . .	37
Figure 37.	Get System Info frame exchange between VCD and LRI64 . . . . .	38
Figure 38.	LRI64 synchronous timing, transmit and receive . . . . .	40
Figure 39.	A1 Antenna on tape outline . . . . .	42
Figure 40.	A6 Antenna on tape outline . . . . .	43
Figure 41.	A7 Antenna on tape outline . . . . .	44
Figure 42.	8-lead Ultra thin Fine pitch Dual Flat Package No lead (MLP) outline . . . . .	45

# 1 Description

The LRI64 is a contactless memory, powered by an externally transmitted radio wave. It contains a 120-bit non-volatile memory. The memory is organized as 15 blocks of 8 bits, of which 7 blocks are accessible as Write-Once Read-Many (WORM) memory.

**Figure 1. Logic diagram**

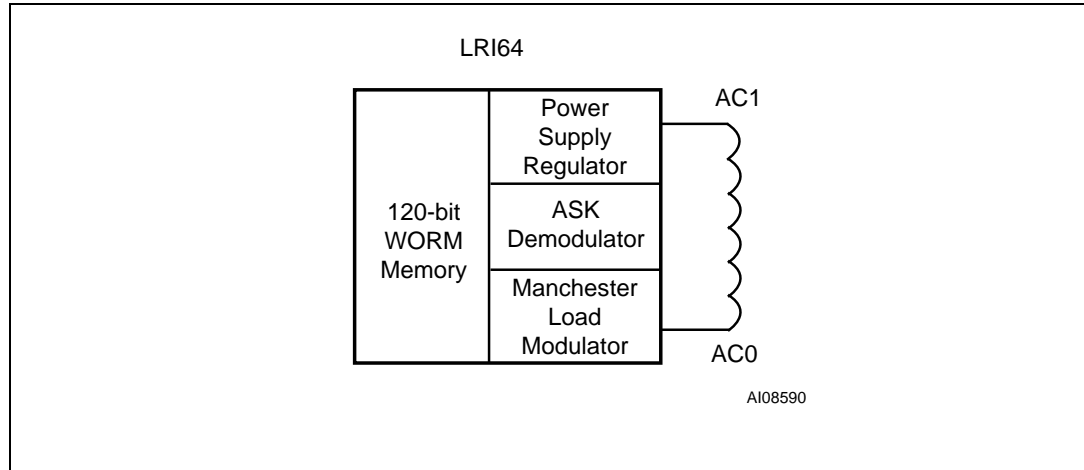

The LRI64 is accessed using a 13.56 MHz carrier wave. Incoming data are demodulated from the received Amplitude Shift Keying (ASK) signal, 10% modulated. The data are transferred from the reader to the LRI64 at 26 Kbit/s, using the “1-out-of-4” pulse encoding mode.

Outgoing data are sent by the LRI64, generated by load variation on the carrier wave, using Manchester coding with a single sub-carrier frequency of 423 kHz. The data are transferred from the LRI64 to the reader at 26 Kbit/s, in the high data rate mode.

The LRI64 supports the high data rate communication protocols of ISO 15693 and ISO 18000-3 Mode 1 recommendations. All other data rates and modulations are not supported by the LRI64.

**Table 1. Signal names**

AC1	Antenna Coil
AC0	Antenna Coil

**Figure 2. MLP connections**

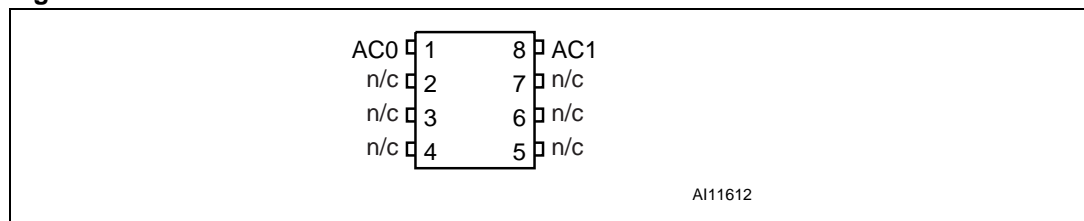

1. n/c means not connected internally.

## 1.1 Memory mapping

The LRI64 is organized as 15 blocks of 8 bits as shown in [Figure 3](#). Each block is automatically write-protected after the first valid write access.

**Figure 3. LRI64 memory mapping**

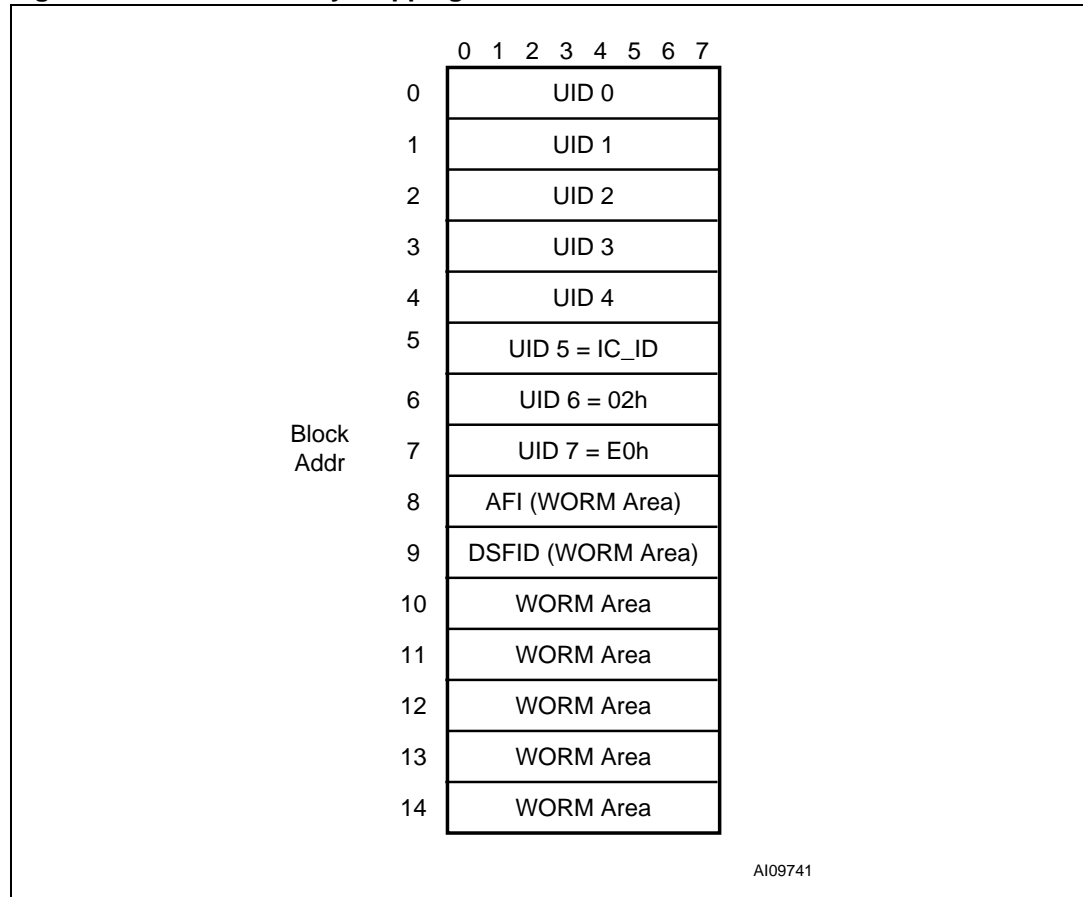

The LRI64 uses the first 8 blocks (blocks 0 to 7) to store the 64-bit Unique Identifier (UID). The UID is used during the anti-collision sequence (Inventory). It is written, by ST, at time of manufacture, but part of it can be customer-accessible and customer-writable, on special request.

The LRI64 has an AFI register, in which to store the Application Family Identifier value, which is also used during the anti-collision sequence.

The LRI64 has a DSFID register, in which to store the Data Storage Format Identifier value, which is used for the LRI64 Inventory answer.

The five following blocks (blocks 10 to 14) are Write-Once Read-Many (WORM) memory. It is possible to write to each of them once. After the first valid write access, the block is automatically locked, and only read commands are possible.



## 2 Signal description

### AC1, AC0

The pads for the Antenna Coil. AC1 and AC0 must be directly bonded to the antenna.

## 3 Commands

The LRI64 supports the following commands:

### 3.1 Inventory

Used to perform the anti-collision sequence. The LRI64 answers to the Inventory command when all of the 64 bits of the UID have been correctly written.

### 3.2 Stay Quiet

Used to put the LRI64 in Quiet mode. In this mode, the LRI64 only responds to commands in Addressed mode.

### 3.3 Read Block

Used to output the 8 bits of the selected block.

### 3.4 Write Block

Used to write a new 8-bit value in the selected block, provided that the block is not locked. This command can be issued only once to each block.

### 3.5 Get\_System\_Info

Used to allow the application system to identify the product. It gives the LRI64 memory size, and IC reference (IC\_ID).

### 3.6 Initial Dialogue for Vicinity Cards

The dialogue between the Vicinity Coupling Device (VCD) and the LRI64 is conducted according to a technique called Reader Talk First (RTF). This involves the following sequence of operations:

1. activation of the LRI64 by the RF operating field of the VCD
2. transmission of a command by the VCD
3. transmission of a response by the LRI64

## 4 Power transfer

Power transfer to the LRI64 is accomplished by inductive coupling of the 13.56MHz radio signal between the antennas of the LRI64 and VCD. The RF field transmitted by the VCD induces an AC voltage on the LRI64 antenna, which is then rectified, smoothed and voltage-regulated. Any amplitude modulation present on the signal is demodulated by the Amplitude Shift Keying (ASK) demodulator.

### 4.1 Frequency

ISO 15693 and ISO 18000-3 Mode 1 standards define the carrier frequency ( $f_C$ ) of the operating field to be  $13.56\text{MHz} \pm 7\text{kHz}$ .

### 4.2 Operating field

The LRI64 operates continuously between  $H_{\min}$  and  $H_{\max}$ .

- The minimum operating field is  $H_{\min}$  and has a value of 150mA/m (rms).
- The maximum operating field is  $H_{\max}$  and has a value of 5A/m (rms).

A VCD generates a field of at least  $H_{\min}$  and not exceeding  $H_{\max}$  in the operating volume.

## 5 Communication signal from VCD to LRI64

Communications between the VCD and the LRI64 involves a type of Amplitude Modulation called Amplitude Shift Keying (ASK).

The LRI64 only supports the 10% modulation mode specified in ISO 15693 and ISO 18000-3 Mode 1 standards. Any request that the VCD might send using the 100% modulation mode, is ignored, and the LRI64 remains in its current state. However, the LRI64 is, in fact, operational for any degree of modulation index from between 10% and 30%.

The modulation index is defined as  $(a-b)/(a+b)$  where a and b are the peak and minimum signal amplitude, respectively, of the carrier frequency, as shown in [Figure 4](#).

**Table 2. 10% modulation parameters**

Parameter	Min	Max
hr	–	0.1 x (a-b)
hf	–	0.1 x (a-b)

**Figure 4. 10% modulation waveform**

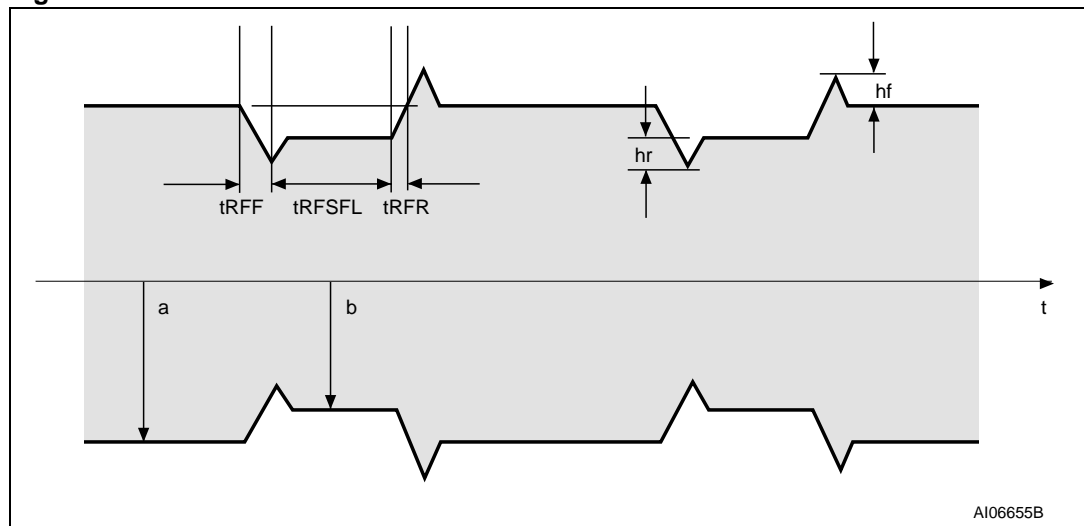

**Figure 5. “1-out-of-4” coding example**

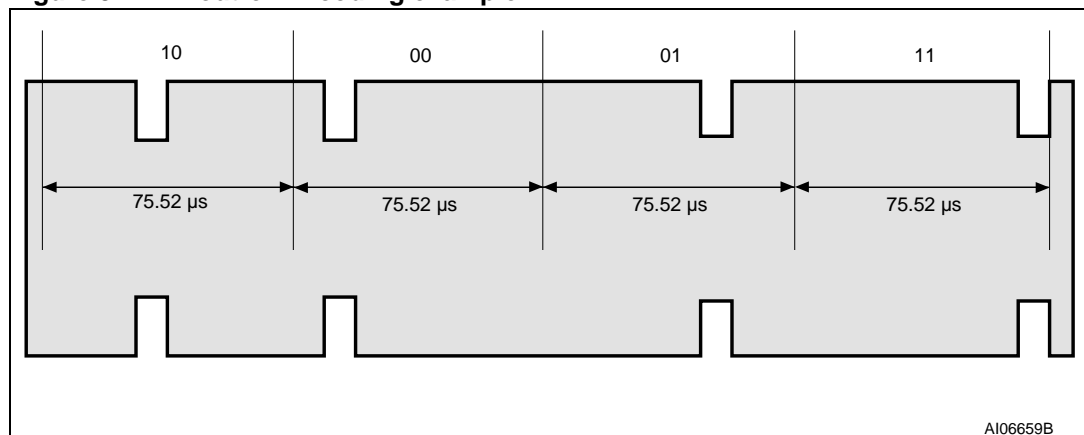

## 6 Data rate and data coding

The data coding method involves pulse position modulation. The LRI64 supports the “1-out-of-4” pulse coding mode. Any request that the VCD might send in the “1-out-of-256” pulse coded mode, is ignored, and the LRI64 remains in its current state.

Two bit values are encoded at a time, by the positioning of a pause of the carrier frequency in one of four possible 18.88µs ( $256/f_C$ ) time slots, as shown in [Figure 6](#).

Four successive pairs of bits form a byte. The transmission of one byte takes 302.08 µs and, consequently, the data rate is 26.48 kbits/s ( $f_C/512$ ).

The encoding for the least significant pair of bits is transmitted first. For example [Figure 5](#) shows the transmission of E1h (225d, 1110 0001b) by the VCD.

**Figure 6. “1-out-of-4” coding mode**

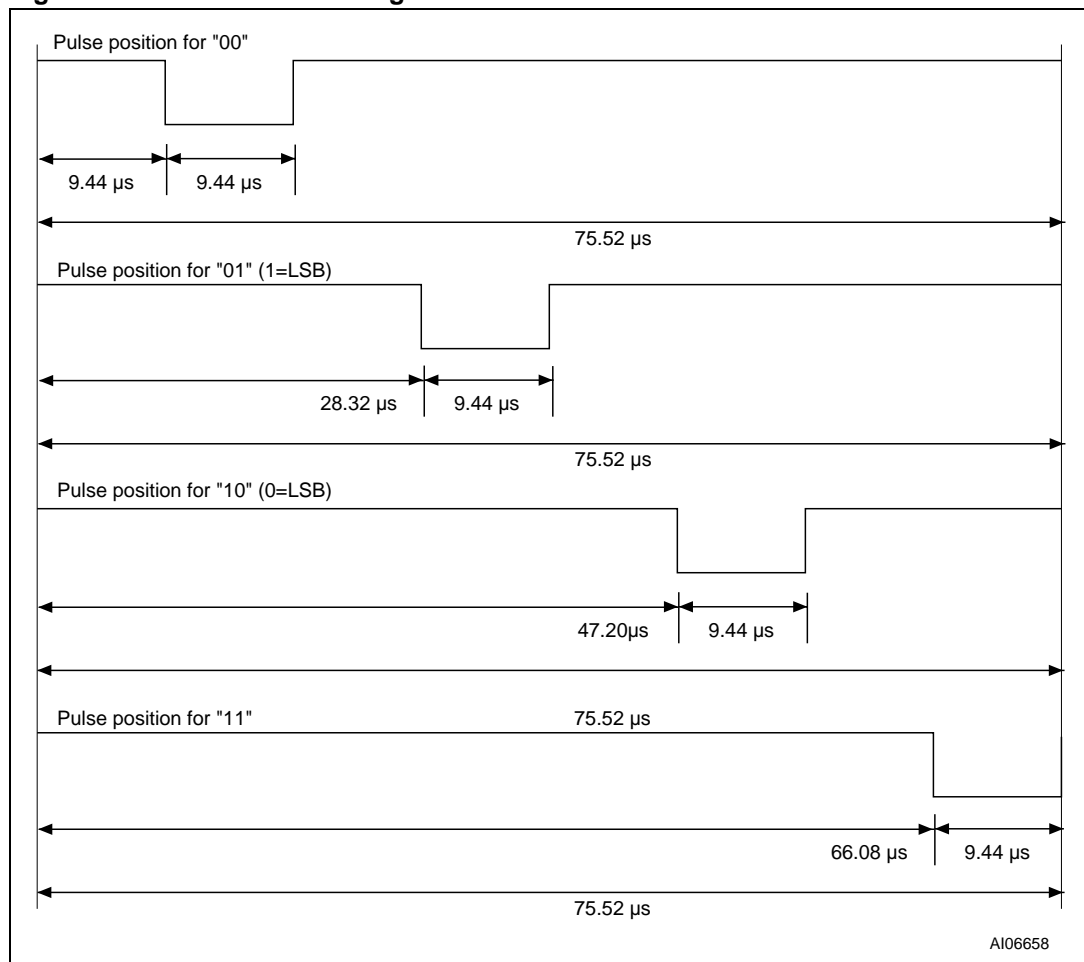

## 7 VCD to LRI64 frames

Request Frames are delimited by a Start of Frame (SOF) and an End of Frame (EOF) and are implemented using a code violation mechanism. Unused options are reserved for future use.

The LRI64 is ready to receive a new command frame from the VCD after a delay of  $t_2$  (see [Table 14](#)) after having sent a response frame to the VCD.

The LRI64 generates a Power On delay of  $t_{POR}$  (see [Table 14](#)) after being activated by the powering field. After this delay, the LRI64 is ready to receive a command frame from the VCD.

In ISO 15693 and ISO 18000-3 Mode 1 standards, the SOF is used to define the data coding mode that the VCD is going to use in the following command frame.

The SOF that is shown in [Figure 7](#) selects the “1-out-of-4” data coding mode. (The LRI64 does not support the SOF for the “1-out-of-256” data coding mode.)

The corresponding EOF sequence is shown in [Figure 8](#).

**Figure 7. Request SOF, using the “1-out-of-4” data coding mode**

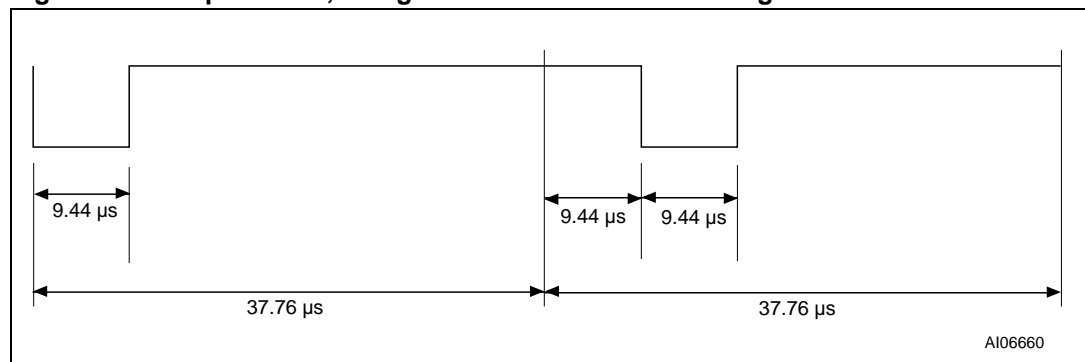

**Figure 8. Request EOF**

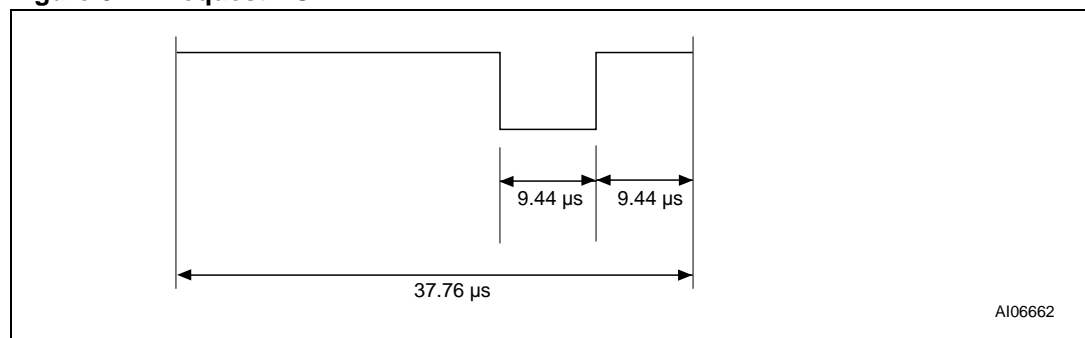

## 8 Communications signal from LRI64 to VCD

ISO 15693 and ISO 18000-3 Mode 1 standards define several modes, for some parameters, to cater for use in different application requirements and noise environments. The LRI64 does not support all of these modes, but supports the single subcarrier mode at the fast data rate.

### 8.1 Load modulation

The LRI64 is capable of communication to the VCD via the inductive coupling between the two antennas. The carrier is loaded, with a subcarrier with frequency  $f_S$ , generated by switching a load in the LRI64.

The amplitude of the variation to the signal, as received on the VCD antenna, is at least 10mV, when measured as described in the test methods defined in International Standard ISO10373-7.

### 8.2 Subcarrier

The LRI64 supports the one subcarrier modulation response format. This format is selected by the VCD using the first bit in the protocol header.

The frequency,  $f_S$ , of the subcarrier load modulation is 423.75kHz ( $=f_C/32$ ).

### 8.3 Data rate

The LRI64 response uses the high data rate format (26.48 kbits/s). The selection of the data rate is made by the VCD using the second bit in the protocol header.

### 8.4 Bit representation and coding using one subcarrier, at the high data rate

Data bits are encoded using Manchester coding, as described in [Figure 9](#) and [Figure 10](#).

#### 8.4.1 Logic 0

A logic 0 starts with 8 pulses of 423.75 kHz ( $f_C/32$ ) followed by an unmodulated period of 18.88  $\mu$ s as shown in [Figure 9](#).

**Figure 9. Logic 0, high data rate**

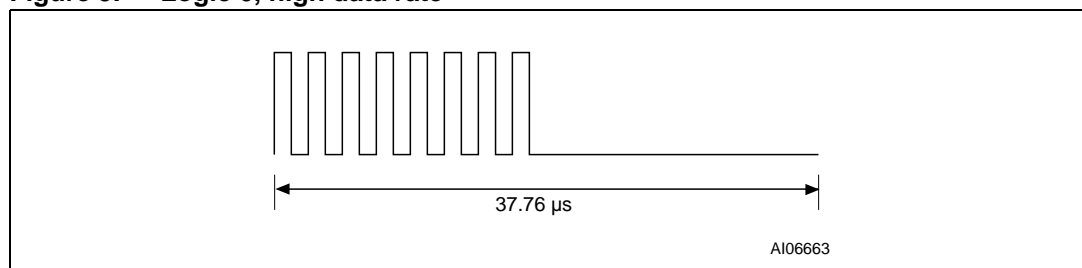

### 8.4.2 Logic 1

A logic 1 starts with an unmodulated period of 18.88  $\mu\text{s}$  followed by 8 pulses of 423.75 kHz ( $f_c/32$ ) as shown in [Figure 10](#).

**Figure 10. Logic 1, high data rate**

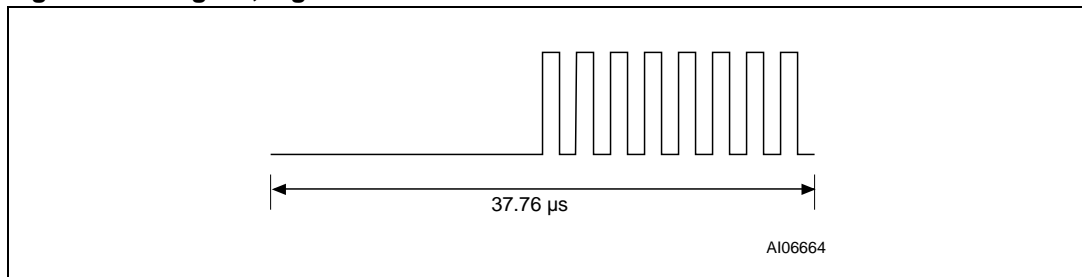

## 9 LRI64 to VCD frames

Response Frames are delimited by a Start of Frame (SOF) and an End of Frame (EOF) and are implemented using a code violation mechanism. The LRI64 supports these in the one subcarrier mode, at the fast data rate, only.

The VCD is ready to receive a response frame from the LRI64 before  $320.9\mu\text{s}$  ( $t_1$ ) after having sent a command frame.

### 9.1 LRI64 SOF

SOF comprises three parts: (see [Figure 11](#))

- an unmodulated period of  $56.64\mu\text{s}$ ,
- 24 pulses of  $423.75\text{ kHz}$  ( $f_C/32$ ),
- a logic 1 which starts with an unmodulated period of  $18.88\mu\text{s}$  followed by 8 pulses of  $423.75\text{ kHz}$ .

### 9.2 LRI64 EOF

EOF comprises three parts: (see [Figure 12](#))

- a logic 0 which starts with 8 pulses of  $423.75\text{ kHz}$  followed by an unmodulated period of  $18.88\mu\text{s}$ .
- 24 pulses of  $423.75\text{ kHz}$  ( $f_C/32$ ),
- an unmodulated time of  $56.64\mu\text{s}$ .

**Figure 11. Response SOF, using high data rate and one subcarrier**

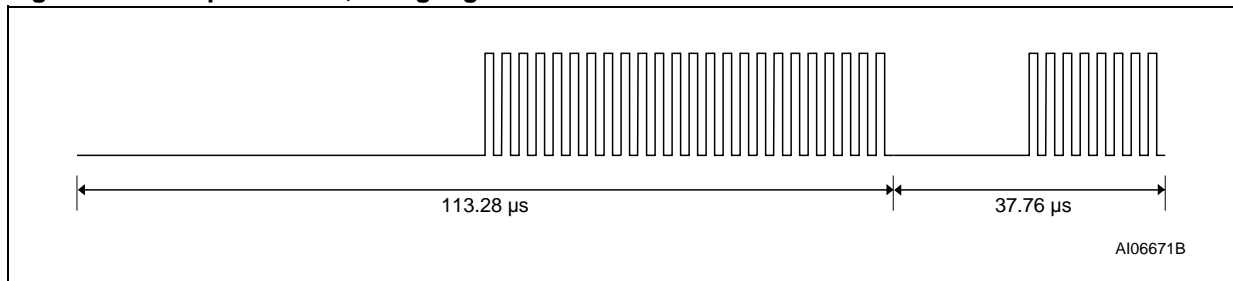

**Figure 12. Response EOF, using high data rate and one subcarrier**

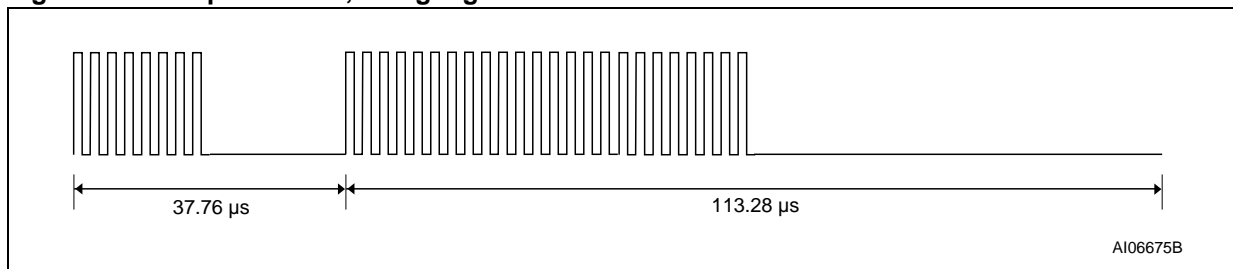



# 10 Special fields

## 10.1 Unique Identifier (UID)

Members of the LRI64 family are uniquely identified by a 64-bit Unique Identifier (UID). This is used for addressing each LRI64 device uniquely and individually, during the anti-collision loop and for one-to-one exchange between a VCD and an LRI64.

The UID complies with ISO/IEC 15963 and ISO/IEC 7816-6. It is a read-only code, and comprises (as summarized in *Figure 13*):

- 8-bit prefix, the most significant bits, set at E0h
- 8-bit IC Manufacturer code (ISO/IEC 7816-6/AM1), set at 02h (for STMicroelectronics)
- 48-bit Unique Serial Number

**Figure 13. UID format**

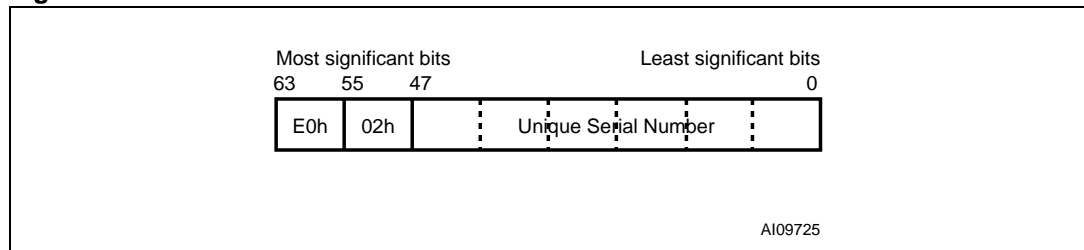

**Figure 14. Decision tree for AFI**

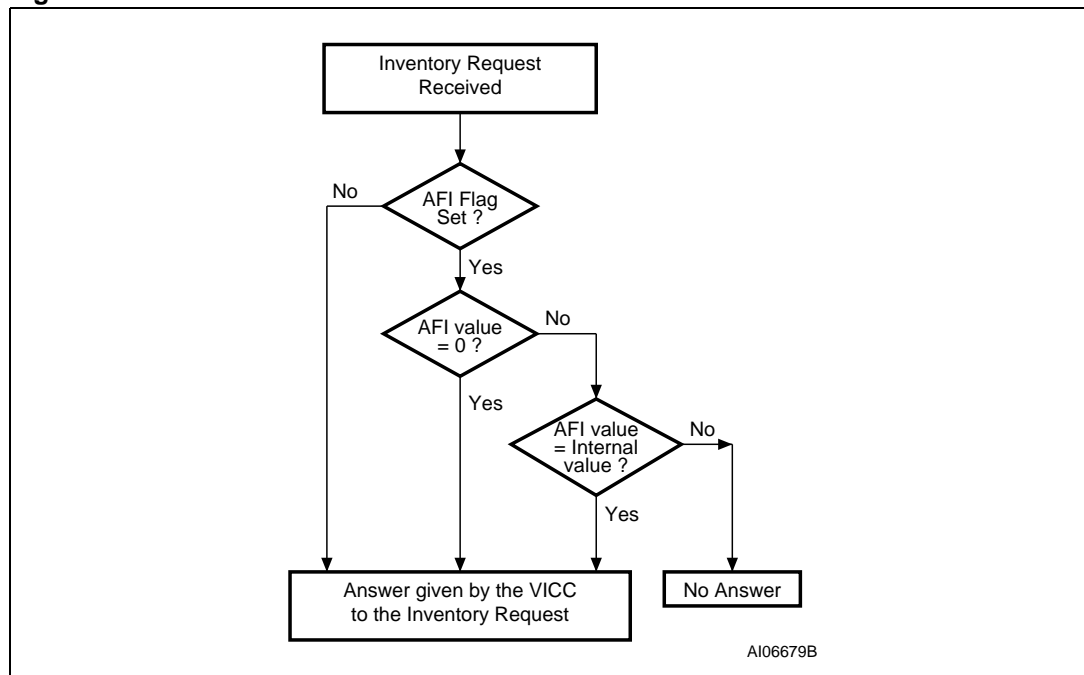

## 10.2 Application Family Identifier (AFI)

The Application Family Identifier (AFI) indicates the type of application targeted by the VCD, and is used to select only those LRI64 devices meeting the required application criteria (as summarized in [Figure 14](#)). The value is programmed by the LRI64 issuer in the AFI register. Once programmed, it cannot be modified.

The most significant nibble of the AFI is used to indicate one specific application, or all families. The least significant nibble of the AFI is used to code one specific sub-families, or all sub-families. Sub-family codes, other than 0, are proprietary (as described in ISO 15693 and ISO 18000-3 Mode 1 documentation).

## 10.3 Data Storage Format Identifier (DSFID)

The Data Storage Format Identifier (DSFID) indicates how the data is structured in the LRI64 memory. It is coded on one byte. It allows for quick and brief knowledge on the logical organization of the data. It is programmed by the LRI64 issuer in the DSFID register. Once programmed, it cannot be modified.

## 10.4 Cyclic Redundancy Code (CRC)

The Cyclic Redundancy Code (CRC) is calculated as defined in ISO/IEC 13239, starting from an initial register content of all ones: FFFFh.

The 2-byte CRC is appended to each Request and each Response, within each frame, before the EOF. The CRC is calculated on all the bytes after the SOF, up to the CRC field.

Upon reception of a Request from the VCD, the LRI64 verifies that the CRC value is valid. If it is invalid, it discards the frame, and does not answer the VCD.

Upon reception of a Response from the LRI64, it is recommended that the VCD verify that the CRC value is valid. If it is invalid, the actions that need to be performed are up to the VCD designer.

The CRC is transmitted Least Significant Byte first. Each byte is transmitted Least Significant Bit first, as shown in [Figure 15](#).

**Figure 15. CRC format**

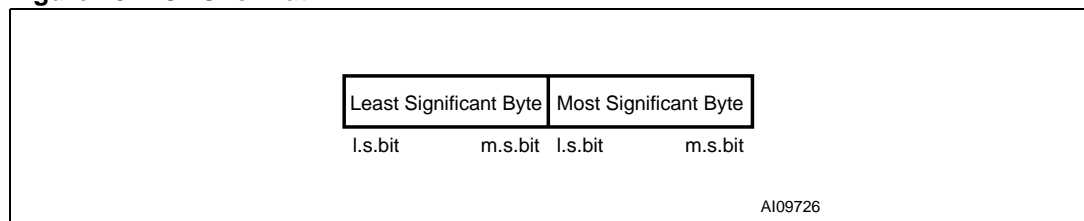

## 11 LRI64 protocol description

The Transmission protocol defines the mechanism to exchange instructions and data between the VCD and the LRI64, in each direction. Based on “VCD talks first”, the LRI64 does not start transmitting unless it has received and properly decoded an instruction sent by the VCD.

The protocol is based on an exchange of:

- a Request from the VCD to the LRI64
- a Response from the LRI64 to the VCD

Each Request and each Response are contained in a Frame. The frame delimiters (SOF, EOF) are described in the previous paragraphs.

Each Request (*Figure 16*) consists of:

- Request SOF (*Figure 7*)
- Request Flags (*Table 3* to *Table 5*)
- Command Code
- Parameters (depending on the Command)
- Application Data
- 2-byte CRC (*Figure 15*)
- Request EOF (*Figure 8*)

Each Response (*Figure 17*) consists of:

- Response SOF (*Figure 11*)
- Response Flags (*Table 6*)
- Parameters (depending on the Command)
- Application Data
- 2-byte CRC (*Figure 15*)
- Response EOF (*Figure 12*)

The number of bits transmitted in a frame is a multiple of eight, and thus always an integer number of bytes.

Single-byte fields are transmitted Least Significant Bit first.

Multiple-byte fields are transmitted Least Significant Byte first, with each byte transmitted Least Significant Bit first.

The setting of the flags indicates the presence of any optional fields. When the flag is set, 1, the field is present. When the flag is reset, 0, the field is absent.

**Figure 16. VCD request frame format**

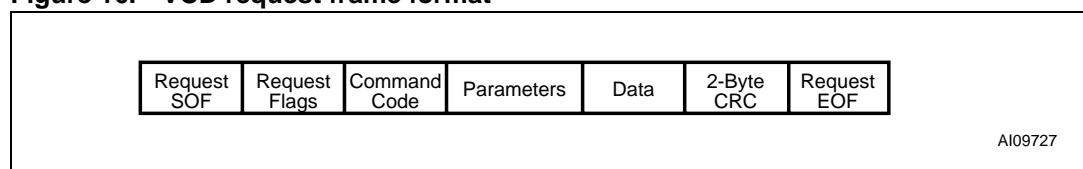

**Figure 17. LRI64 response frame format**

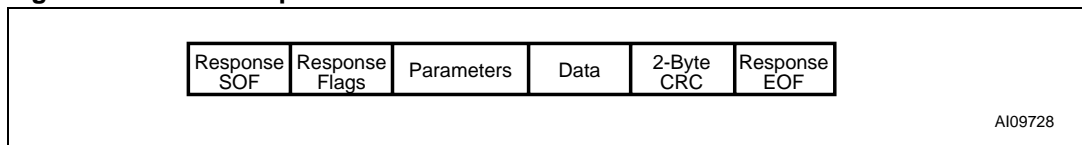

**Figure 18. LRI64 protocol timing**

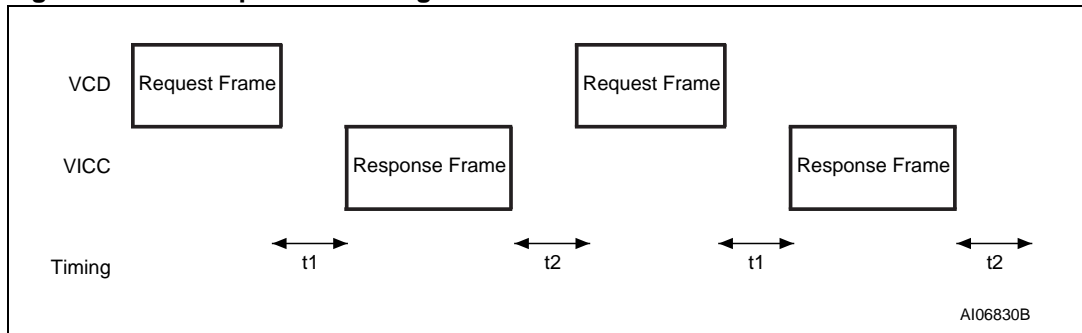

## 12 LRI64 states

A LRI64 can be in any one of three states:

- Power-off
- Ready
- Quiet

Transitions between these states are as specified in [Figure 19](#).

### 12.1 Power-off state

The LRI64 is in the Power-off state when it receives insufficient energy from the VCD.

### 12.2 Ready state

The LRI64 is in the Ready state when it receives enough energy from the VCD. It answers to any Request in Addressed and Non-addressed modes.

### 12.3 Quiet state

When in the Quiet State, the LRI64 answers to any Request in Addressed mode.

# 13 Modes

The term mode refers to the mechanism for specifying, in a Request, the set of LRI64 devices that shall answer to the Request.

## 13.1 Addressed mode

When the Address\_flag is set to 1 (Addressed mode), the Request contains the Unique ID (UID) of the addressed LRI64 device (such as an LRI64 device). Any LRI64 receiving a Request in which the Address\_flag is set to 1, compares the received Unique ID to its own UID. If it matches, it execute the Request (if possible) and returns a Response to the VCD, as specified by the command description. If it does not match, the LRI64 device remains silent.

## 13.2 Non-addressed mode (General Request)

When the Address\_flag is set to 0 (Non-addressed mode), the Request does not contain a Unique ID field. Any LRI64 device receiving a Request in which the Address\_flag is set to 0, executes the Request and returns a Response to the VCD as specified by the command description.

Figure 19. LRI64 state transition diagram

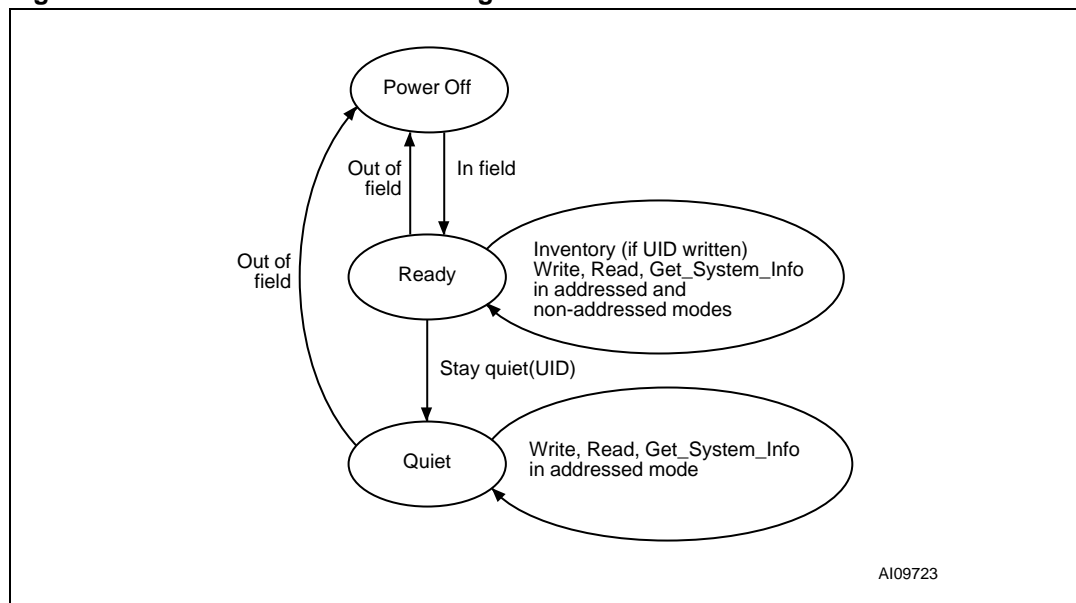

## 14 Flags and error codes

### 14.1 Request flags

In a Request, the 8-bit Flags Field specifies the actions to be performed by the LRI64, and whether corresponding fields are present or not.

Flag bit 3 (the Inventory\_flag) defines the way the four most significant flag bits (5 to 8) are used. When bit 3 is reset (0), bits 5 to 8 define the LRI64 selection criteria. When bit 3 is set (1), bits 5 to 8 define the LRI64 Inventory parameters.

**Table 3. Request flags 1 to 4**

Bit	Name	Value <sup>(1)</sup>	Description
1	Sub-carrier Flag	0	Single sub-carrier frequency mode. (Option 1 is not supported)
2	Data_rate Flag	1	High data rate mode. (Option 0 is not supported)
3	Inventory Flag	0	Flags 5 to 8 meaning are according to <a href="#">Table 4</a>
		1	Flags 5 to 8 meaning are according to <a href="#">Table 5</a>
4	Protocol Extension Flag	0	No Protocol format extension. Must be set to 0. (Option 1 is not supported)

1. If the value of the Request Flag is a non authorized value, the LRI64 does not execute the command, and does not respond to the request.

**Table 4. Request flags 5 to 8 (when bit 3 = 0)**

Bit	Name	Value <sup>(1)</sup>	Description
5	Select Flag	0	No selection mode. Must be set to 0. (Option 1 is not supported)
6	Address Flag	0	Non addressed mode. The UID field is not present in the request. All LRI64 shall answer to the request.
		1	Addressed mode. The UID field is present in the request. Only the LRI64 that matches the UID answers the request.
7	Option Flag <sup>(1)</sup>	0	No option. Must be set to 0. (Option 1 is not supported)
8	RFU <sup>(1)</sup>	0	No option. Must be set to 0. (Option 1 is not supported)

1. Only bit 6 (Address flag) can be configured for the LRI64. All others bits (5, 7 and 8) must be reset to 0.

**Table 5. Request flags 5 to 8 (when bit 3 = 1)**

Bit	Name	Value <sup>(1)</sup>	Description
5	AFI Flag	0	AFI field is not present
		1	AFI field is present
6	Nb_slots Flag	0	16 slots
		1	1 slot
7	Option Flag	0	No option. Must be set to 0. (Option 1 is not supported)
8	RFU	0	No option. Must be set to 0. (Option 1 is not supported)

1. Bits 7 and 8 must be reset to 0.

## 14.2 Response flags

In a Response, the 8-bit Flags Field indicates how actions have been performed by the LRI64, and whether corresponding fields are present or not.

**Table 6. Response flags 1 to 8**

Bit	Name	Value	Description
1	Error Flag	0	No error
		1	Error detected. Error code is in the "Error" field.
2	RFU	0	
3	RFU	0	
4	RFU	0	
5	RFU	0	
6	RFU	0	
7	RFU	0	
8	RFU	0	

## 14.3 Response error code

If the Error Flag is set by the LRI64 in the Response, the Error Code Field is present and provides information about the error that occurred. [Table 7](#) shows the one error code that is supported by the LRI64.

**Table 7. Response error code**

Error code	Meaning
0Fh	Error with no specific information given



## 15 Anti-collision

The purpose of the anti-collision sequence is to allow the VCD to compile a list of the LRI64 devices that are present in the VCD field, each one identified by its unique ID (UID).

The VCD is the master of the communication with one or multiple LRI64 devices. It initiates the communication by issuing the Inventory Request ([Figure 22](#)).

### 15.1 Request flags

The Nb\_slots\_flag needs to be set appropriately. The AFI Flag needs to be set, if the Optional AFI Field is to be present.

### 15.2 Mask length and mask value

The Mask Length defines the number of significant bits in the Mask Value.

The Mask Value is contained in an integer number of bytes.

The least significant bit of each is transmitted first.

If the Mask Length is not a multiple of 8 (bits), the most significant end of the Mask Value is padded with the required number of null bits (set to 0) so that the Mask Value is contained in an integer number of bytes, so that the next field (the 2-Byte CRC) starts at the next byte boundary.

In the example of [Figure 20](#), the Mask Length is 11 bits. The Mask Value, 10011001111, is padded out at the most significant end with five bits set to 0. The 11 bits Mask plus the current slot number is compared to the UID.

### 15.3 Inventory responses

Each LRI64 sends its Response in a given time slot, or else remains silent.

The first slot starts immediately after the reception of the Request EOF.

To switch to the next slot, the VCD sends another EOF.

The following rules and restrictions apply:

- if no LRI64 answer is detected, the VCD may switch to the next slot by sending an EOF
- if one or more LRI64 answers are detected, the VCD waits until the complete frame has been received before sending an EOF, to switch to the next slot.

The pulse shall be generated according to the definition of the EOF in ISO 15693 and ISO 18000-3 Mode 1 standards.

Figure 20. Comparison between the Mask, Slot Number and UID

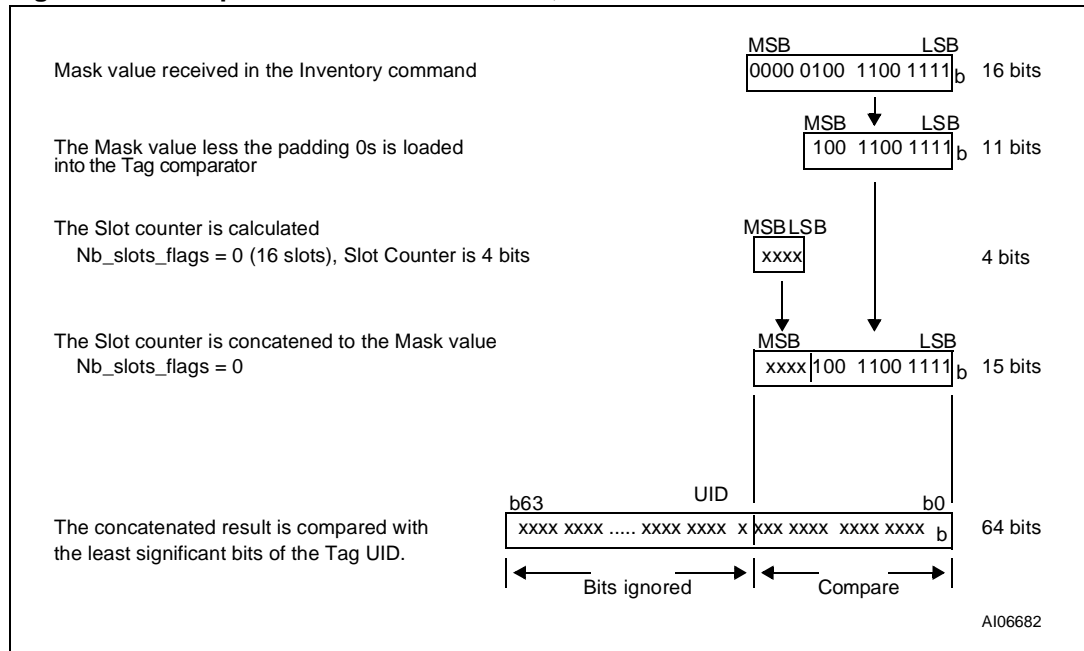

## 16 Request processing by the LRI64

Upon reception of a valid Request, the LRI64 performs the following algorithm, where:

- $NbS$  is the total number of slots (1 or 16)
- $SN$  is the current slot number (0 to 15)
- The function  $LSB(value, n)$  returns the  $n$  least significant bits of  $value$
- The function  $MSB(value, n)$  returns the  $n$  most significant bits of  $value$
- “&” is the concatenation operator
- $Slot\_Frame$  is either a SOF or an EOF

```
SN = 0
if (Nb_slots_flag)
  then NbS = 1
       SN_length = 0
       endif
  else NbS = 16
       SN_length = 4
       endif

label1:
if LSB(UID, SN_length + Mask_length) =
  LSB(SN, SN_length) & LSB(Mask, Mask_length)
  then answer to inventory request
  endif

wait (Slot_Frame)

if Slot_Frame = SOF
  then Stop Anticollision
       decode/process request
       exit
  endif

if Slot_Frame = EOF
  if SN < NbS-1
    then SN = SN + 1
         goto label1
         exit
    endif
  endif
```

## 16.1 Explanation of the possible cases

*Figure 21* summarizes the main possible cases that can occur during an anti-collision sequence when the number of slots is 16.

The different steps are:

- The VCD sends an Inventory Request, in a frame, terminated by a EOF. The number of slots is 16.
- LRI64 #1 transmits its Response in Slot 0. It is the only one to do so, therefore no collision occurs and its UID is received and registered by the VCD;
- The VCD sends an EOF, to switch to the next slot.
- In slot 1, two LRI64 devices, #2 and #3, transmit their Responses. This generates a collision. The VCD records it, and remembers that a collision was detected in Slot 1.
- The VCD sends an EOF, to switch to the next slot.
- In Slot 2, no LRI64 transmits a Response. Therefore the VCD does not detect a LRI64 SOF, and decides to switch to the next slot by sending an EOF.
- In slot 3, there is another collision caused by Responses from LRI64 #4 and #5
- The VCD then decides to send a Request (for instance a Read Block) to LRI64 #1, whose UID was already correctly received.
- All LRI64 devices detect a SOF and exit the anti-collision sequence. They process this Request and since the Request is addressed to LRI64 #1, only LRI64 #1 transmits its Response.
- All LRI64 devices are ready to receive another Request. If it is an Inventory command, the slot numbering sequence restarts from 0.

*Note:* The decision to interrupt the anti-collision sequence is up to the VCD. It could have continued to send EOFs until Slot 15 and then send the Request to LRI64 #1.

Figure 21. Description of a possible anti-collision sequence between LRI64 devices

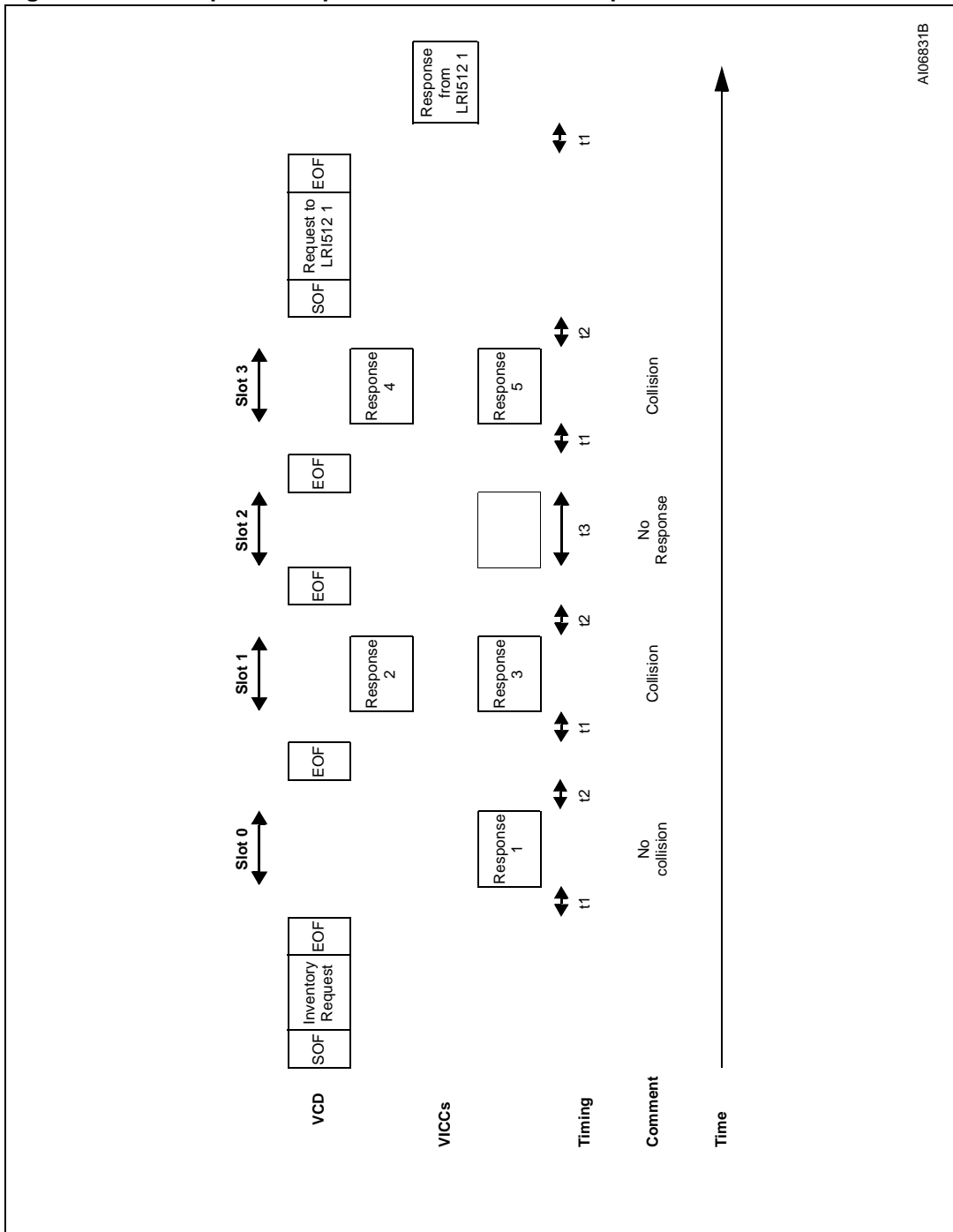

A106831B

## 17 Timing definitions

*Figure 21* shows three specific delay times:  $t_1$ ,  $t_2$  and  $t_3$ . All of them have a minimum value, specified in *Table 14*. The  $t_1$  parameter also has a maximum and a typical value specified in *Table 14*, as summarized in *Table 8*.

**Table 8. Timing values<sup>(1)</sup>**

	Min.	Typ.	Max.
$t_1$	$t_1(\text{min})$	$t_1(\text{typ}) = 4352 / f_C$	$t_1(\text{max})$
$t_2$	$t_2(\text{min}) = 4192 / f_C$	—	—
$t_3$	$t_1(\text{max}) + t_{\text{SOF}}$ (see notes <sup>(2),(3)</sup> )	—	—

1. The tolerance of specific timings is  $\pm 32/f_C$ .
2.  $t_{\text{SOF}}$  is the duration for the LRI64 to transmit an SOF to the VCD.
3.  $t_1(\text{max})$  does not apply for write alike requests. Timing conditions for write alike requests are defined in the command description.

### 17.1 LRI64 response delay, $t_1$

Upon detection of the rising edge of the EOF received from the VCD, the LRI64 waits for a time equal to

$$t_1(\text{typ}) = 4352 / f_C$$

before starting to transmit its response to a VCD request, or switching to the next slot when in an inventory process.

### 17.2 VCD new request delay, $t_2$

$t_2$  is the time after which the VCD may send an EOF to switch to the next slot when one or more LRI64 responses have been received during an inventory command. It starts from the reception of the EOF received from the LRI64 devices.

The EOF sent by the VCD is 10% modulated, independent of the modulation index used for transmitting the VCD request to the LRI64.

$t_2$  is also the time after which the VCD may send a new request to the LRI64 as described in *Figure 18*.

$$t_2(\text{min}) = 4192 / f_C$$

### 17.3 VCD new request delay when there is no LRI64 response, $t_3$

$t_3$  is the time after which the VCD may send an EOF to switch to the next slot when no LRI64 response has been received.

The EOF sent by the VCD is 10% modulated, independent of the modulation index used for transmitting the VCD request to the LRI64.

From the time the VCD has generated the rising edge of an EOF:

- The VCD waits for a time at least equal to the sum of  $t_3(\text{min})$  and the typical response time of an LRI64, which depends on the data rate and subcarrier modulation mode, before sending a subsequent EOF.

# 18 Command codes

The LRI64 supports the command codes listed in [Table 9](#).

**Table 9. Command codes**

Command code	Function
01h	Inventory
02h	Stay Quiet
20h	Read Single Block
21h	Write Single Block
2Bh	Get System Info

## 18.1 Inventory

When receiving the Inventory request, the LRI64 performs the anti-collision sequence. The `Inventory_flag` is set to 1. The meanings of Flags 5 to 8 is as described in [Table 5](#).

The Request Frame ([Figure 22](#)) contains:

- Request Flags ([Table 3](#) and [Table 5](#))
- Inventory Command Code (01h, [Table 9](#))
- AFI, if the AFI Flag is set
- Mask Length
- Mask Value
- 2-byte CRC ([Figure 15](#))

In case of errors in the Inventory request frame, the LRI64 does not generate any answer.

The Response Frame ([Figure 23](#)) contains:

- Response Flags ([Table 6](#))
- DSFID
- Unique ID
- 2-byte CRC ([Figure 15](#))

**Figure 22. Inventory, request frame format**

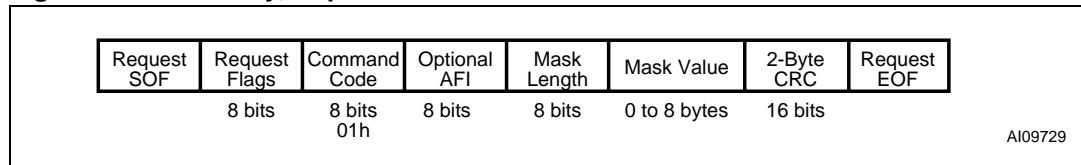

**Figure 23. Inventory, response frame format**

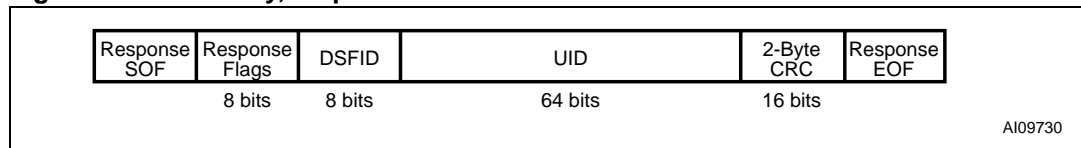



## 18.2 Stay Quiet

The Stay Quiet Command is always executed in Addressed Mode (the Address\_Flag is set to 1).

The Request Frame (*Figure 24*) contains:

- Request Flags (22h, as described in *Table 3* and *Table 4*)
- Stay Quiet Command Code (02h, *Table 9*)
- Unique ID
- 2-byte CRC (*Figure 15*)

When receiving the Stay Quiet command, the LRI64 enters the Quiet State and does *not* send back a Response. There is *no* response to the Stay Quiet Command.

When in the Quiet State:

- the LRI64 does not process any Request in which the Inventory\_flag is set
- the LRI64 responds to commands in the Addressed mode if the UID matches

The LRI64 exits the Quiet State when it is taken to the Power Off state (*Figure 19*).

**Figure 24. Stay Quiet, request frame format**

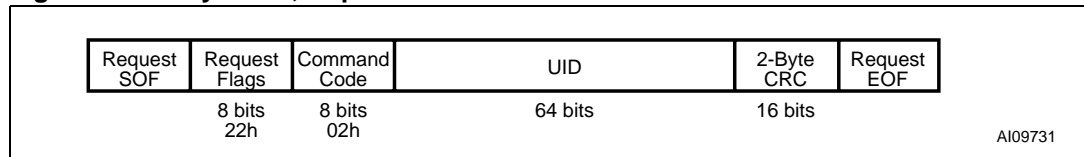

**Figure 25. Stay Quiet frame exchange between VCD and LRI64**

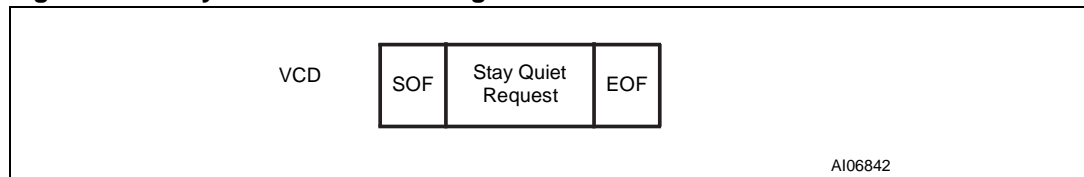

### 18.3 Read Single Block

When receiving the Read Single Block Command, the LRI64 reads the requested block and sends back its 8-bit value in the Response. The Option\_Flag is supported. The Read Single Block can be issued in both addressed and non addressed modes.

The Request Frame (*Figure 26*) contains:

- Request Flags (*Table 3* and *Table 4*)
- Read Single Block Command Code (20h, *Table 9*)
- Unique ID (Optional)
- Block Number
- 2-byte CRC (*Figure 15*)

If there is no error, at the LRI64, the Response Frame (*Figure 27*) contains:

- Response Flags (*Table 6*)
- Block Locking Status, if Option\_Flag is set
- 1 byte of Block Data (*Table 10*)
- 2-byte CRC (*Figure 15*)

Otherwise, if there is an error, the Response Frame (*Figure 28*) contains:

- Response Flags (01h, *Table 6*)
- Error Code (0Fh, *Table 7*)
- 2-byte CRC (*Figure 15*)

**Table 10. Block lock status**

Bit	Name	Value	Description
0	Block Locked	0	Current Block not locked
		1	Current Block locked
1 to 7	RFU	0	

**Figure 26. Read Single Block, request frame format**

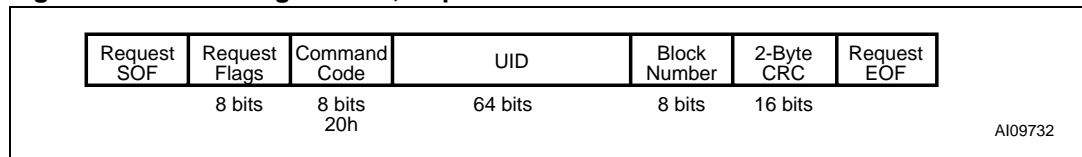

**Figure 27. Read Single Block, response frame format, when Error\_Flag is not set**

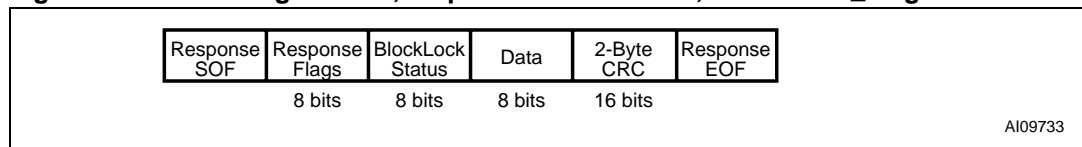

**Figure 28. Read Single Block, response frame format, when Error\_Flag is set**

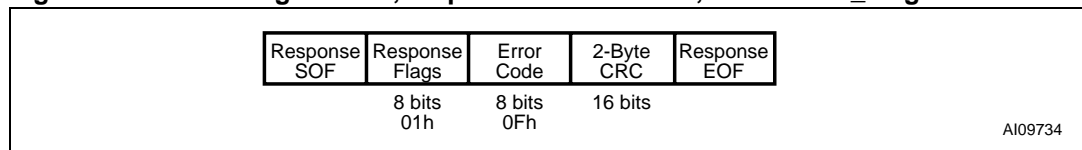

**Figure 29. READ Single Block frame exchange between VCD and LRI64**

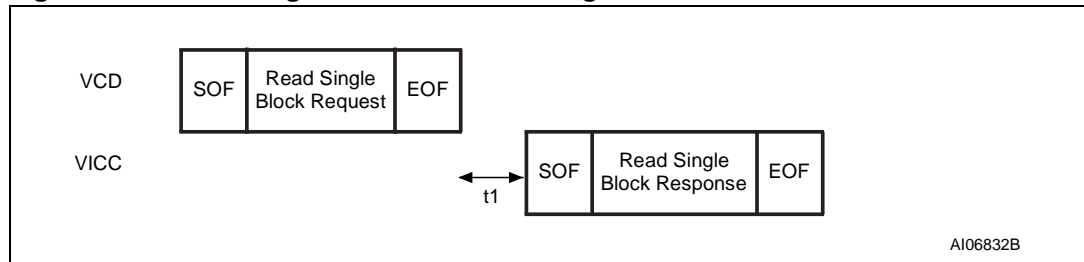

## 18.4 Write Single Block

When receiving the Write Single Block command, the LRI64 writes the requested block with the data contained in the Request and report the success of the operation in the Response. The Option\_Flag is not supported and must be set to 0. The Write Single Block can be issued in both addressed and non addressed modes.

During the write cycle  $t_W$ , no modulation shall occur, otherwise the LRI64 may program the data incorrectly in the memory.

The Request Frame ([Figure 30](#)) contains:

- Request Flags ([Table 3](#) and [Table 4](#))
- Write Single Block Command Code (21h, [Table 9](#))
- Unique ID (Optional)
- Block Number
- Data
- 2-byte CRC ([Figure 15](#))

If there is no error, at the LRI64, an empty Response Frame ([Figure 31](#)) is sent back after the write cycle, containing no parameters. It just contains:

- Response Flags ([Table 6](#))
- 2-byte CRC ([Figure 15](#))

Otherwise, if there is an error, the Response Frame ([Figure 32](#)) contains:

- Response Flags (01h, [Table 6](#))
- Error Code (0Fh, [Table 7](#))
- 2-byte CRC ([Figure 15](#))

**Figure 30. Write Single Block, request frame format**

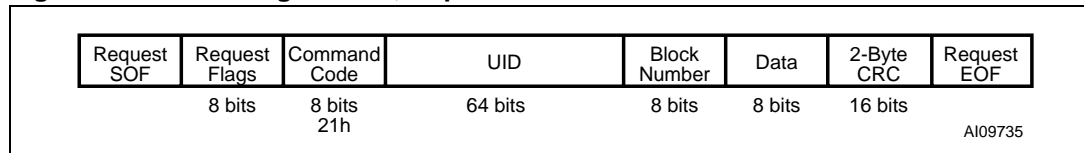

**Figure 31. Write Single Block, response frame format, when Error\_Flag is not set**

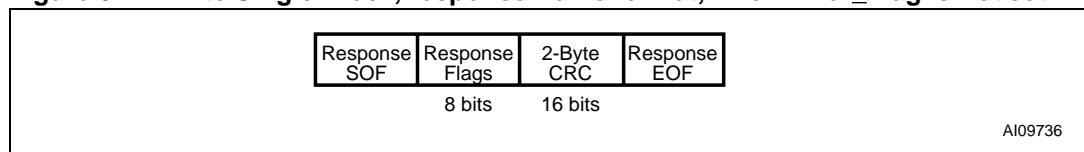

**Figure 32. Write Single Block, response frame format, when Error\_Flag is set**

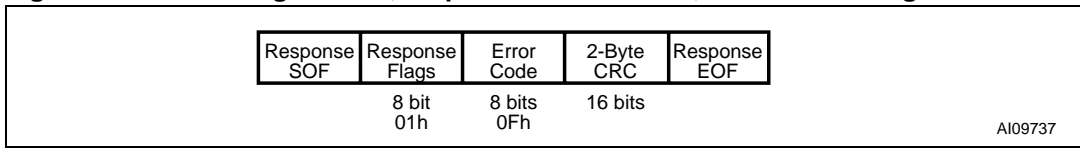

**Figure 33. Write Single Block frame exchange between VCD and LRI64**

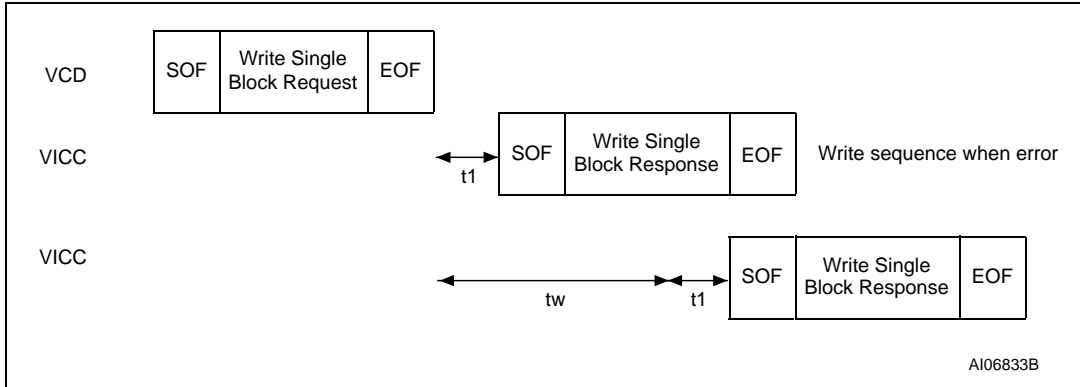

## 18.5 Get System Info

When receiving the Get System Info command, the LRI64 send back its information data in the Response. The Option\_Flag is not supported and must be set to 0. The Get System Info can be issued in both addressed and non addressed modes.

The Request Frame ([Figure 26](#)) contains:

- Request Flags ([Table 3](#) and [Table 4](#))
- Get System Info Command Code (2Bh, [Table 9](#))
- Unique ID (Optional)
- 2-byte CRC ([Figure 15](#))

If there is no error, at the LRI64, the Response Frame ([Figure 27](#)) contains:

- Response Flags ([Table 6](#))
- Information Flags set to 0Fh, indicating the four information fields that are present (DSFID, AFI, Memory Size, IC Reference)
- Unique ID
- DSFID value (as written in block 9)
- AFI value (as written in block 8)
- Memory size: for the LRI64, there are 15 blocks (0Eh) of 1 byte (00h).
- IC Reference: only the 6 most significant bits are used. The product code of the LRI64 is  $00\ 0101_b = 5_d$
- 2-byte CRC ([Figure 15](#))

Otherwise, if there is an error, the Response Frame ([Figure 28](#)) contains:

- Response Flags (01h, [Table 6](#))
- Error Code (0Fh, [Table 7](#))
- 2-byte CRC ([Figure 15](#))

**Figure 34. Get System Info, request frame format**

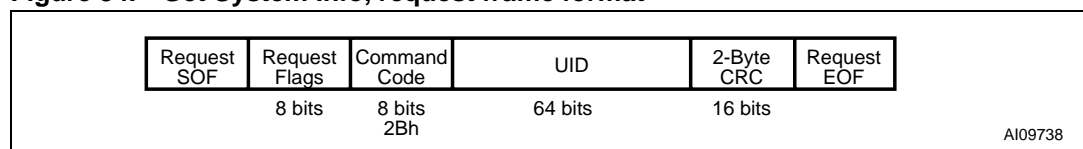

**Figure 35. Get System Info, response frame format, when Error\_Flag is not set**

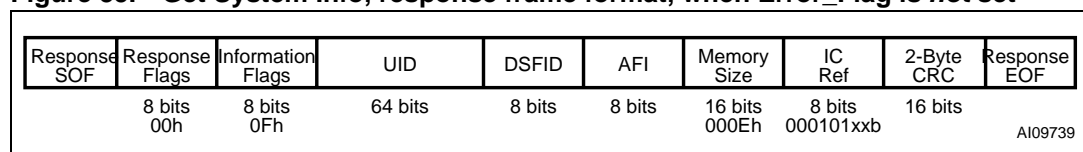

**Figure 36. Get System Info, response frame format, when Error\_Flag is set**

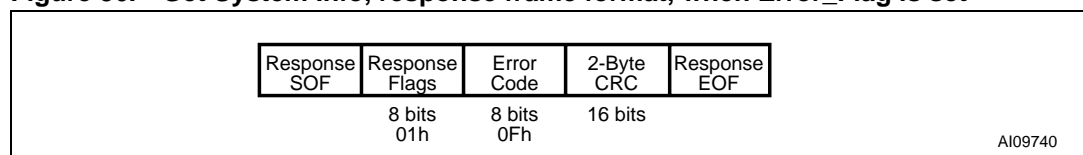
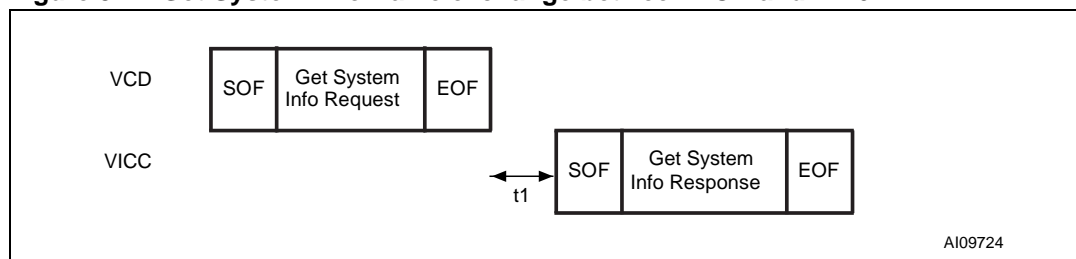

Figure 37. Get System Info frame exchange between VCD and LRI64



## 19 Maximum rating

Stressing the device above the rating listed in the Absolute Maximum Ratings table may cause permanent damage to the device. These are stress ratings only and operation of the device at these or any other conditions above those indicated in the Operating sections of this specification is not implied. Exposure to Absolute Maximum Rating conditions for extended periods may affect device reliability. Refer also to the STMicroelectronics SURE Program and other relevant quality documents.

**Table 11. Absolute maximum ratings**

Symbol	Parameter	Min.	Max.	Unit	
$T_{STG}$ , $h_{STG}$ , $t_{STG}$	Storage Conditions	Wafer	15	25	°C
				23	months
			kept in its antistatic bag		
		A1, A6, A7	15	25	°C
			40%	60%	RH
				2	years
$I_{CC}$	Supply Current on AC0 / AC1	-20	20	mA	
$V_{MAX}$	Input Voltage on AC0 / AC1	-7	7	V	
$V_{ESD}$	Electrostatic Discharge Voltage <sup>(1)</sup> (2)	A1, A6, A7	-7000	7000	V

1. Mil. Std. 883 - Method 3015
2. ESD test: ISO10373-7 specification

## 20 DC and AC parameters

This section summarizes the operating and measurement conditions, and the DC and AC characteristics of the device. The parameters in the DC and AC Characteristic tables that follow are derived from tests performed under the Measurement Conditions summarized in the relevant tables. Designers should check that the operating conditions in their circuit match the measurement conditions when relying on the quoted parameters.

**Table 12. Operating conditions**

Symbol	Parameter	Min.	Max.	Unit
T <sub>A</sub>	Ambient operating temperature	-20	85	°C

**Figure 38. LRI64 synchronous timing, transmit and receive**

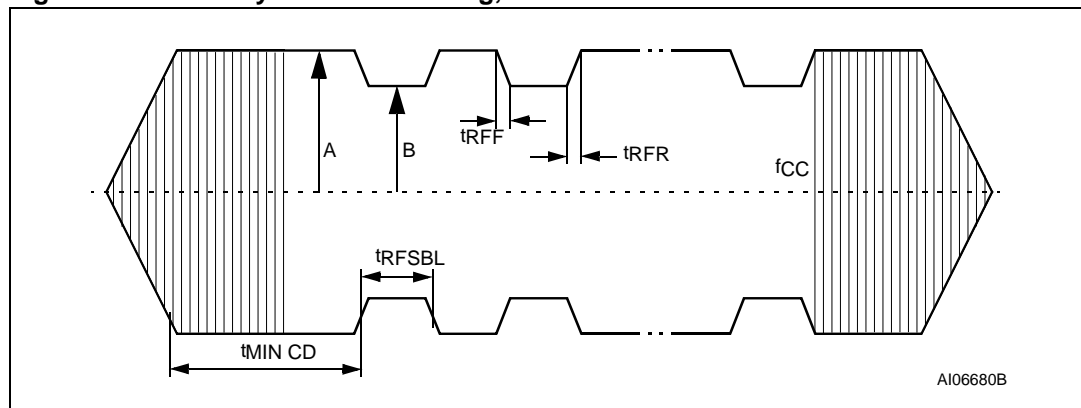

Figure 38 shows an ASK modulated signal, from the VCD to the LRI64. The test condition for the AC/DC parameters are:

- Close coupling condition with tester antenna (1mm)
- Gives LRI64 performance on tag antenna

**Table 13. DC characteristics**

Symbol	Parameter	Test conditions <sup>(1)</sup>	Min.	Typ.	Max.	Unit
V <sub>CC</sub>	Regulated Voltage		1.5		3.0	V
V <sub>RET</sub>	Retromodulated Induced Voltage	ISO10373-7	10			mV
I <sub>CC</sub>	Supply Current	Read	V <sub>CC</sub> = 3.0 V		50	μA
		Write	V <sub>CC</sub> = 3.0 V		150	μA
C <sub>TUN</sub>	Internal Tuning Capacitor	f=13.56 MHz for W4/1		21		pF
		f=13.56 MHz for W4/2		28.5		pF
		f=13.56 MHz for W4/3		97		pF

1. T<sub>A</sub> = -20 to 85 °C



Table 14. AC characteristics

Symbol	Parameter	Test conditions <sup>(1),(2)</sup>	Min.	Typ.	Max.	Unit
$f_C$	External RF Signal Frequency		13.553	13.56	13.567	MHz
$MI_{\text{CARRIER}}$	10% Carrier Modulation Index	$MI=(A-B)/(A+B)$	10		30	%
$t_{\text{RFR}}, t_{\text{RFF}}$	10% Rise and Fall Time		0		3.0	$\mu\text{s}$
$t_{\text{RFSBL}}$	10% Minimum Pulse Width for Bit		7.1		9.44	$\mu\text{s}$
$t_{\text{JIT}}$	Bit Pulse Jitter		-2		+2	$\mu\text{s}$
$t_{\text{MINCD}}$	Minimum Time from Carrier Generation to First Data	From H-field min		0.1	1	ms
$f_{\text{SH}}$	Subcarrier Frequency High	$f_C/32$		423.75		kHz
$t_1$	Time for LRI64 Response	$4352/f_C$	313	320.9	322	$\mu\text{s}$
$t_2$	Time between Commands	$4224/f_C$	309	311.5	314	$\mu\text{s}$
$t_W$	Programming Time	$93297/f_C$			6.88	ms

1.  $T_A = -20$  to  $85$  °C

2. All timing measurements were performed on a reference antenna with the following characteristics:  
 External size: 75mm x 48mm  
 Number of turns: 6  
 Width of conductor: 1mm  
 Space between 2 conductors: 0.4mm  
 Value of the Tuning Capacitor: 28.5pF (LRI64-W4)  
 Value of the coil: 4.3 $\mu$ H  
 Tuning Frequency: 14.4MHz.

## 21 Package mechanical

In order to meet environmental requirements, ST offers these devices in ECOPACK® packages. These packages have a Lead-free second-level interconnect. The category of Second-Level Interconnect is marked on the package and on the inner box label, in compliance with JEDEC Standard JESD97.

The maximum ratings related to soldering conditions are also marked on the inner box label. ECOPACK is an ST trademark. ECOPACK specifications are available at: [www.st.com](http://www.st.com).

**Figure 39. A1 Antenna on tape outline**

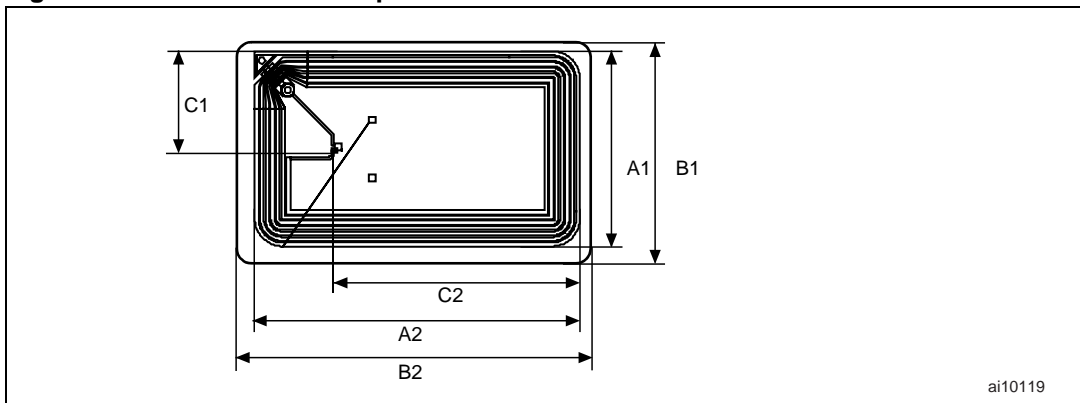

1. Drawing is not to scale.

**Table 15. A1 Antenna on tape mechanical data**

Symbol	Parameter	Typ	Min	Max	Unit
A1	Coil Width	45	44.5	45.5	mm
A2	Coil Length	76	75.5	76.5	mm
B1	Antenna Cut Width	49	48.8	49.2	mm
B2	Antenna Cut Length	82	81.8	82.2	mm
C1	Die Position from Antenna	23	22.8	23.2	mm
C2	Die Position from Antenna	56	55.8	56.2	mm
	Silicon Thickness	180	165	195	µm
Q	Unloaded Q value	35			
F <sub>NOM</sub>	Unloaded free-air resonance	15.1			MHz
P <sub>A</sub>	H-field Energy for Device Operation		0.03 90		A/m dBµA/m

Figure 40. A6 Antenna on tape outline

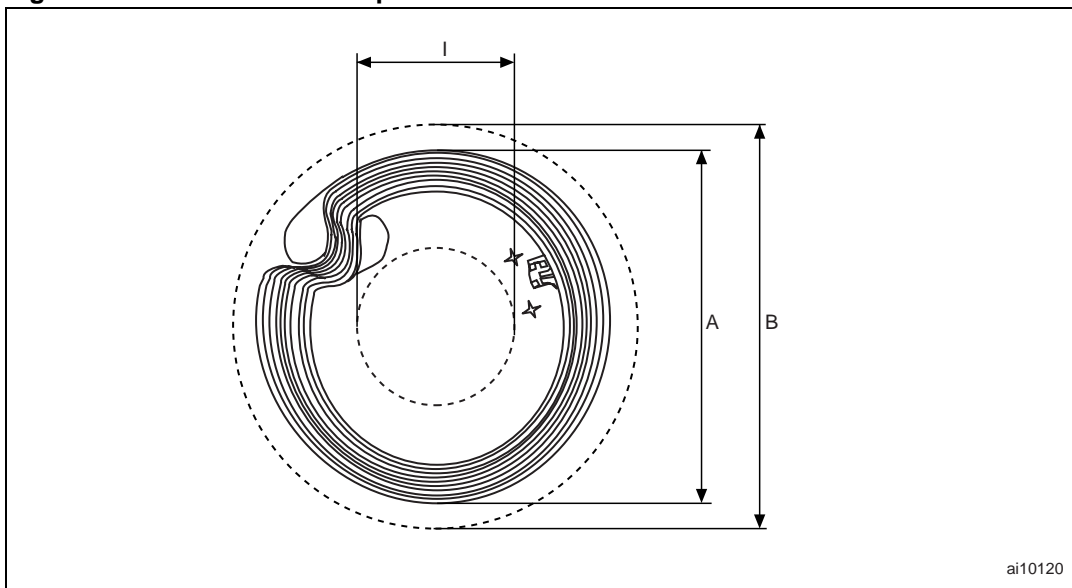

1. Drawing is not to scale.

Table 16. A6 Antenna on tape mechanical data

Symbol	Parameter	Typ	Min	Max	Unit
A	Coil Diameter	35	34.5	35.5	mm
B	Antenna cut diameter	40	38.8	40.2	mm
I	Hole Diameter	16	15.8	16.2	mm
	Overall Thickness of copper antenna coil	80	70	90	μm
	Silicon Thickness	180	165	195	μm
Q	Unloaded Q value	35			
F <sub>NOM</sub>	Unloaded free-air resonance	15.1			MHz
P <sub>A</sub>	H-field Energy for Device Operation		0.5 114		A/m dBμA/m

Figure 41. A7 Antenna on tape outline

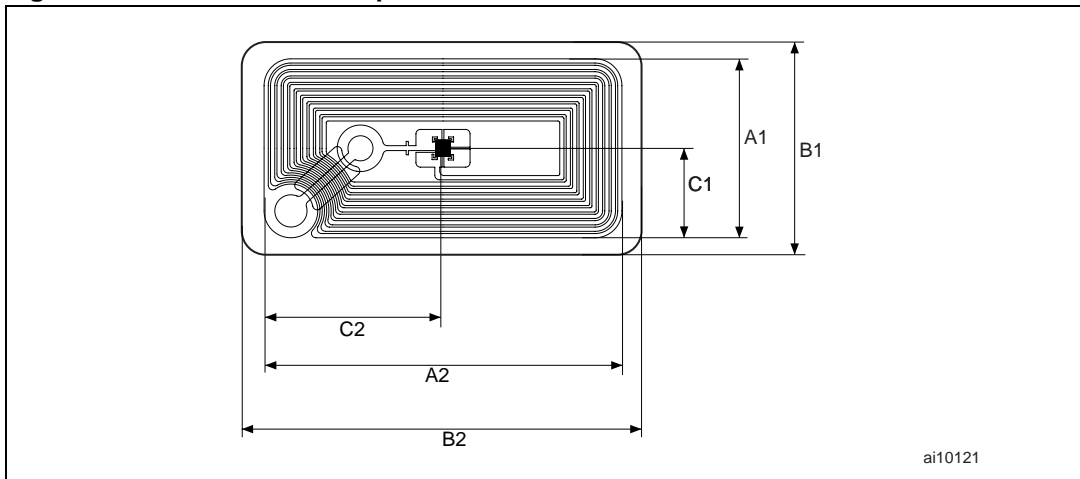

1. Drawing is not to scale.

Table 17. A7 Antenna on tape mechanical data

Symbol	Parameter	Typ	Min	Max	Unit
A1	Coil Width	40	39.5	40.5	mm
A2	Coil Length	20	19.5	20.5	mm
B1	Antenna Cut Width	44	43.8	44.2	mm
B2	Antenna Cut Length	24	23.8	24.2	mm
C1	Die Position from Antenna	10	9.8	10.2	mm
C2	Die Position from Antenna	20	19.8	20.2	mm
	Overall Thickness of copper antenna coil	160	145	175	μm
	Silicon Thickness	180	165	195	μm
Q	Unloaded Q value	35			
F <sub>NOM</sub>	Unloaded free-air resonance	15.1			MHz
P <sub>A</sub>	H-field Energy for Device Operation		1 120		A/m dBμA/m

Figure 42. 8-lead Ultra thin Fine pitch Dual Flat Package No lead (MLP) outline

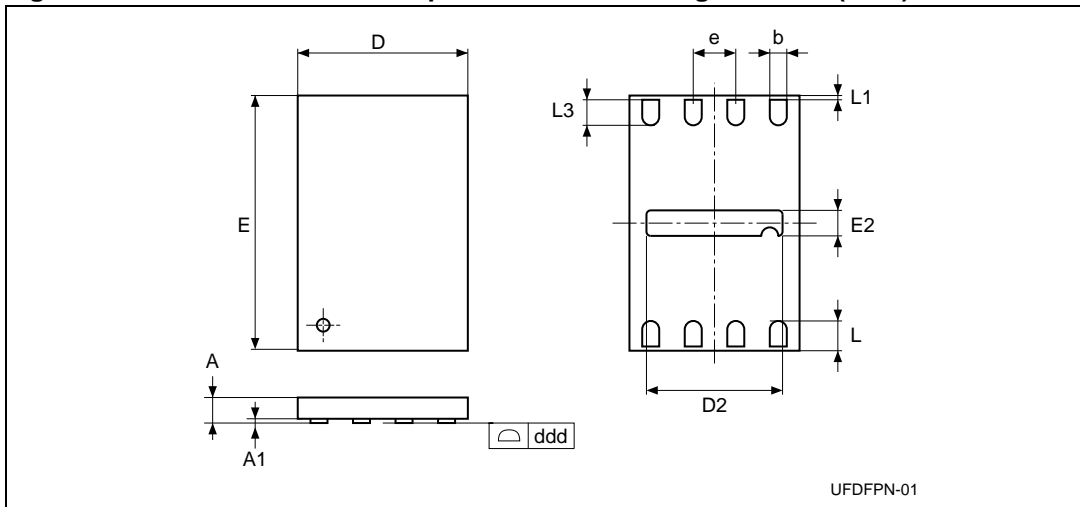

1. Drawing is not to scale.

Table 18. UDFFPN8 (MLP8), 8-lead Ultra thin Fine pitch Dual Flat Package No lead 2 × 3 mm, package mechanical data

Symbol	millimeters			inches		
	Typ	Min	Max	Typ	Min	Max
A	0.55	0.50	0.60	0.022	0.020	0.024
A1	0.02	0.00	0.05	0.001	0.000	0.002
b	0.25	0.20	0.30	0.010	0.008	0.012
D	2.00	1.90	2.10	0.079	0.075	0.083
D2	1.60	1.50	1.70	0.063	0.059	0.067
ddd			0.08			0.003
E	3.00	2.90	3.10	0.118	0.114	0.122
E2	0.20	0.10	0.30	0.008	0.004	0.012
e	0.50	–	–	0.020	–	–
L	0.45	0.40	0.50	0.018	0.016	0.020
L1			0.15			0.006
L3		0.30			0.012	

## 22 Part numbering

**Table 19. Ordering information scheme**

Example:	LRI64	-	W4	/XXX
<b>Device type</b>	LRI64			
<b>Package</b>	W4 = 180 μm ± 15 μm UnsaWn Wafer, 18.5 pF tuning capacitor SBN18 = 180 μm ± 15 μm Bumped and Sawn Wafer on 8-inch Frame A1T = 45 mm × 76 mm Copper Antenna on Continuous Tape A1S = 45 mm × 76 mm Copper Singulated Adhesive Antenna on Tape A6S2U = 35 mm Copper Singulated Adhesive CD Antenna on white PET Tape and no marking A7T = 20 mm × 40 mm Copper Antenna on Continuous Tape MBTG = UDFDFPN8 (MLP8), Tape & Reel Packing, ECOPACK® and RoHS compliant, Sb2O3-free and TBBA-free <sup>(1)</sup>			
<b>Customer code</b>	XXX = Given by STMicroelectronics			

1. The category of second Level Interconnect is marked on the package and on the inner box label, in compliance with JEDEC Standard JESD97. The maximum ratings related to soldering conditions are also marked on the inner box label.

For a list of available options (speed, package, etc.) or for further information on any aspect of this device, please contact your nearest ST Sales Office.

## Appendix A algorithm for pulsed slots

The following pseudo-code describes how the anti-collision could be implemented on the VCD, using recursive functions.

```

function push (mask, address); pushes on private stack
function pop (mask, address); pops from private stack
function pulse_next_pause; generates a power pulse
function store(LRI64_UID); stores LRI64_UID

function poll_loop (sub_address_size as integer)
  pop (mask, address)
  mask = address & mask; generates new mask
    ; send the Request
  mode = anti-collision
  send_Request (Request_cmd, mode, mask length, mask value)
  for sub_address = 0 to (2^sub_address_size - 1)
    pulse_next_pause
    if no_collision_is_detected ; LRI64 is inventoried
      then
        store (LRI64_UID)
      else ; remember a collision was detected
        push(mask,address)
      endif
    next sub_address

    if stack_not_empty ; if some collisions have been detected and
      then ; not yet processed, the function calls itself
        poll_loop (sub_address_size); recursively to process the
last stored collision
      endif
end poll_loop

main_cycle:
  mask = null
  address = null
  push (mask, address)
  poll_loop(sub_address_size)
end_main_cycle

```

## Appendix B C-example to calculate or check the CRC16 according to ISO/IEC 13239

The Cyclic Redundancy Check (CRC) is calculated on all data contained in a message, from the start of the Flags through to the end of Data. This CRC is used from VCD to LRI64 and from LRI64 to VCD.

To add extra protection against shifting errors, a further transformation on the calculated CRC is made. The One's Complement of the calculated CRC is the value attached to the message for transmission.

For checking of received messages the 2 CRC bytes are often also included in the re-calculation, for ease of use. In this case, given the expected value for the generated CRC is the residue of F0B8h

**Table 20. CRC definition**

CRC definition					
CRC Type	Length	Polynomial	Direction	Preset	Residue
ISO/IEC 13239	16 bits	$X^{16} + X^{12} + X^5 + 1 = \text{Ox8408}$	Backward	FFFFh	F0B8h

### 22.1 CRC calculation example

This example in C language illustrates one method of calculating the CRC on a given set of bytes comprising a message.

```
#define POLYNOMIAL0x8408// x^16 + x^12 + x^5 + 1
#define PRESET_VALUE0xFFFF
#define CHECK_VALUE0xF0B8

#define NUMBER_OF_BYTES4// Example: 4 data bytes
#define CALC_CRC1
#define CHECK_CRC0

void main()
{
    unsigned int current_crc_value;
    unsigned char array_of_databytes[NUMBER_OF_BYTES + 2] = {1, 2, 3,
4, 0x91, 0x39};
    int number_of_databytes = NUMBER_OF_BYTES;
    int calculate_or_check_crc;
    int i, j;
    calculate_or_check_crc = CALC_CRC;
    // calculate_or_check_crc = CHECK_CRC;// This could be an other
example
    if (calculate_or_check_crc == CALC_CRC)
    {
        number_of_databytes = NUMBER_OF_BYTES;
    }
}
```



```

else // check CRC
{
    number_of_databytes = NUMBER_OF_BYTES + 2;
}

current_crc_value = PRESET_VALUE;

for (i = 0; i < number_of_databytes; i++)
{
    current_crc_value = current_crc_value ^ ((unsigned
int)array_of_databytes[i]);

    for (j = 0; j < 8; j++)
    {
        if (current_crc_value & 0x0001)
        {
            current_crc_value = (current_crc_value >> 1) ^
POLYNOMIAL;
        }
        else
        {
            current_crc_value = (current_crc_value >> 1);
        }
    }
}

if (calculate_or_check_crc == CALC_CRC)
{
    current_crc_value = ~current_crc_value;

    printf ("Generated CRC is 0x%04X\n", current_crc_value);

    // current_crc_value is now ready to be appended to the data
stream
    // (first LSByte, then MSByte)
}
else // check CRC
{
    if (current_crc_value == CHECK_VALUE)
    {
        printf ("Checked CRC is ok (0x%04X)\n",
current_crc_value);
    }
    else
    {
        printf ("Checked CRC is NOT ok (0x%04X)\n",
current_crc_value);
    }
}
}

```

## Appendix C Application family identifier (AFI) coding

AFI (Application Family Identifier) represents the type of application targeted by the VCD and is used to extract from all the LRI64 present only the LRI64 meeting the required application criteria.

It is programmed by the LRI64 issuer (the purchaser of the LRI64). Once locked, it can not be modified.

The most significant nibble of AFI is used to code one specific or all application families, as defined in [Table 21](#).

The least significant nibble of AFI is used to code one specific or all application sub-families. Sub-family codes different from 0 are proprietary.

**Table 21. AFI coding<sup>(1)</sup>**

AFI Most Significant Nibble	AFI Least Significant Nibble	Meaning LRI64 Devices respond from	Examples / Note
0	0	All families and sub-families	No applicative preselection
x	0	All sub-families of family X	Wide applicative preselection
x	y	Only the Yth sub-family of family X	
0	y	Proprietary sub-family Y only	
1	0, y	Transport	Mass transit, Bus, Airline,...
2	0, y	Financial	IEP, Banking, Retail,...
3	0, y	Identification	Access Control,...
4	0, y	Telecommunication	Public Telephony, GSM,...
5	0, y	Medical	
6	0, y	Multimedia	Internet services....
7	0, y	Gaming	
8	0, y	Data Storage	Portable Files...
9	0, y	Item Management	
A	0, y	Express Parcels	
B	0, y	Postal Services	
C	0, y	Airline Bags	
D	0, y	RFU	
E	0, y	RFU	
F	0, y	RFU	

1. x and y each represent any single-digit hexadecimal value between 1 and F

## Revision history

**Table 22. Document revision history**

Date	Revision	Changes
27-Aug-2003	1.0	First Issue
16-Jul-2004	2.0	First public release of full datasheet
22-Sep-2004	3.0	Values changed for $t_W$ , $t_1$ and $t_2$
11-Jul-2005	4.0	Added MLP package information.
7-Sept-2005	5.0	Modified Option_Flag information in <i>Get System Info</i> command and added ISO 18000-3 Mode 1 compliance.
19-Feb-2007	6	Document reformatted. UDFPN8 package specifications updated (see <a href="#">Table 18: UDFPN8 (MLP8), 8-lead Ultra thin Fine pitch Dual Flat Package No lead 2 x 3 mm, package mechanical data</a> ). ST offers the LRI64 in ECOPACK® compliant UDFPN8 packages. C <sub>TUN</sub> value for W4/3 added to <a href="#">Table 13: DC characteristics</a> . Small text changes.

**Please Read Carefully:**

Information in this document is provided solely in connection with ST products. STMicroelectronics NV and its subsidiaries ("ST") reserve the right to make changes, corrections, modifications or improvements, to this document, and the products and services described herein at any time, without notice.

All ST products are sold pursuant to ST's terms and conditions of sale.

Purchasers are solely responsible for the choice, selection and use of the ST products and services described herein, and ST assumes no liability whatsoever relating to the choice, selection or use of the ST products and services described herein.

No license, express or implied, by estoppel or otherwise, to any intellectual property rights is granted under this document. If any part of this document refers to any third party products or services it shall not be deemed a license grant by ST for the use of such third party products or services, or any intellectual property contained therein or considered as a warranty covering the use in any manner whatsoever of such third party products or services or any intellectual property contained therein.

**UNLESS OTHERWISE SET FORTH IN ST'S TERMS AND CONDITIONS OF SALE ST DISCLAIMS ANY EXPRESS OR IMPLIED WARRANTY WITH RESPECT TO THE USE AND/OR SALE OF ST PRODUCTS INCLUDING WITHOUT LIMITATION IMPLIED WARRANTIES OF MERCHANTABILITY, FITNESS FOR A PARTICULAR PURPOSE (AND THEIR EQUIVALENTS UNDER THE LAWS OF ANY JURISDICTION), OR INFRINGEMENT OF ANY PATENT, COPYRIGHT OR OTHER INTELLECTUAL PROPERTY RIGHT.**

**UNLESS EXPRESSLY APPROVED IN WRITING BY AN AUTHORIZED ST REPRESENTATIVE, ST PRODUCTS ARE NOT RECOMMENDED, AUTHORIZED OR WARRANTED FOR USE IN MILITARY, AIR CRAFT, SPACE, LIFE SAVING, OR LIFE SUSTAINING APPLICATIONS, NOR IN PRODUCTS OR SYSTEMS WHERE FAILURE OR MALFUNCTION MAY RESULT IN PERSONAL INJURY, DEATH, OR SEVERE PROPERTY OR ENVIRONMENTAL DAMAGE. ST PRODUCTS WHICH ARE NOT SPECIFIED AS "AUTOMOTIVE GRADE" MAY ONLY BE USED IN AUTOMOTIVE APPLICATIONS AT USER'S OWN RISK.**

Resale of ST products with provisions different from the statements and/or technical features set forth in this document shall immediately void any warranty granted by ST for the ST product or service described herein and shall not create or extend in any manner whatsoever, any liability of ST.

ST and the ST logo are trademarks or registered trademarks of ST in various countries.

Information in this document supersedes and replaces all information previously supplied.

The ST logo is a registered trademark of STMicroelectronics. All other names are the property of their respective owners.

© 2007 STMicroelectronics - All rights reserved

STMicroelectronics group of companies

Australia - Belgium - Brazil - Canada - China - Czech Republic - Finland - France - Germany - Hong Kong - India - Israel - Italy - Japan - Malaysia - Malta - Morocco - Singapore - Spain - Sweden - Switzerland - United Kingdom - United States of America

[www.st.com](http://www.st.com)