

Features
QFN12L (3 x 3 mm)

- **Low Insertion Loss :** 0.7 dB @ 2.5 GHz
0.9 dB @ 4.9 to 6.0 GHz
- **Isolation:** 25 dB @ 2.5 GHz
30 dB @ 4.9 to 6.0 GHz
- **Low DC Power Consumption**
- **Miniature QFN12L (3x3 mm) Plastic (Pb) Free Package**
- **PHEMT process**
- **Lead Free and RoHS Compliant Version of HWS407**

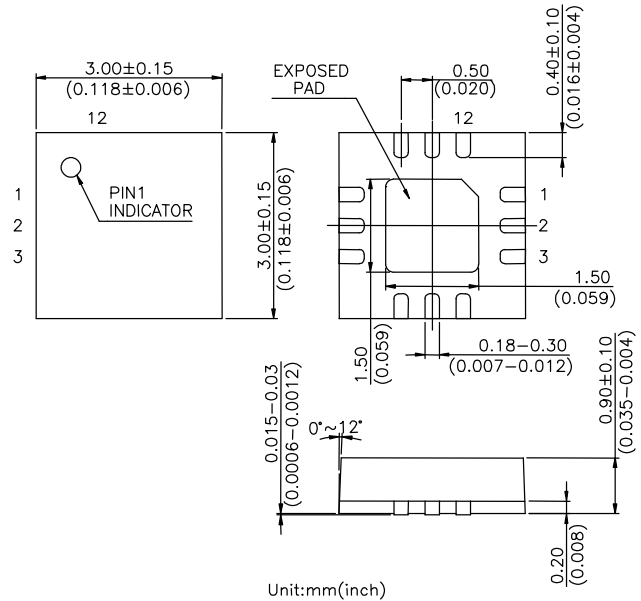

Description

The HWS436 is a GaAs PHEMT MMIC DPDT switch operating at DC-6 GHz in a low cost miniature QFN12L (3 x 3 mm) plastic lead (Pb) free package. The HWS436 features low insertion loss and high isolation with very low DC power consumption. This switch can be used in IEEE 802.11a/b/g WLAN systems for combination of transmit/receive and antenna diversity functions.

Electrical Specifications at 25 °C with 0, +3V Control Voltages

Parameter	Test Conditions	Min.	Typ.	Max.	Unit
Insertion Loss	0.1-6.0 GHz		0.9		dB
	0.1-1.0 GHz		0.6		dB
	2.4-2.5 GHz		0.7		dB
	4.9-6.0 GHz		0.9	1.2	dB
Isolation (on port to off port)	0.1-6.0 GHz		25		dB
	2.4-2.5 GHz		25		dB
	4.9-6.0 GHz	27	30		dB
Isolation (off port to off port)	0.1-6.0 GHz		33		dB
	2.4-2.5 GHz		43		dB
	4.9-6.0 GHz		33		dB
Isolation (TX to RX or ANT1 to ANT2)	0.1-6.0 GHz		22		dB
	2.4-2.5 GHz		25		dB
	4.9-6.0 GHz		22		dB
Return Loss	0.1-6.0 GHz		15		dB
Input Power for One dB Compression	2.0-6.0 GHz		30		dBm
Control Current			20	200	uA

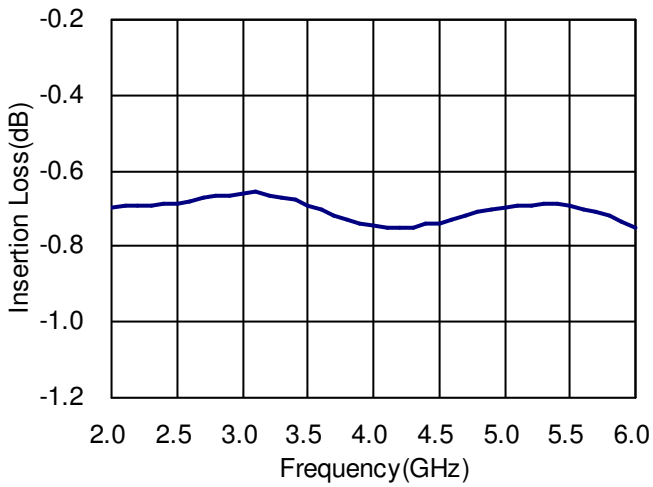
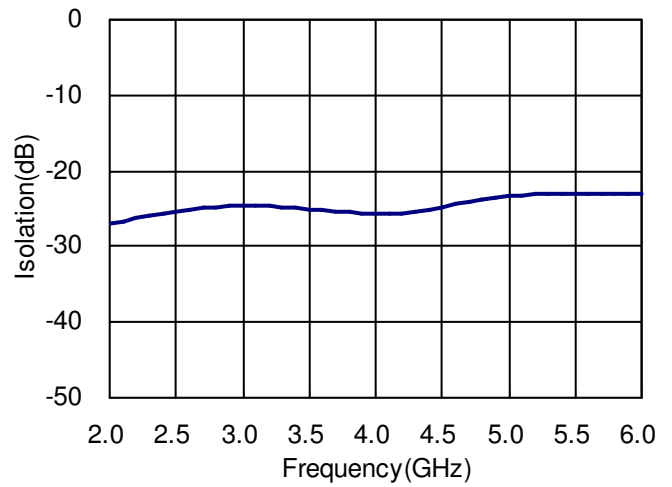
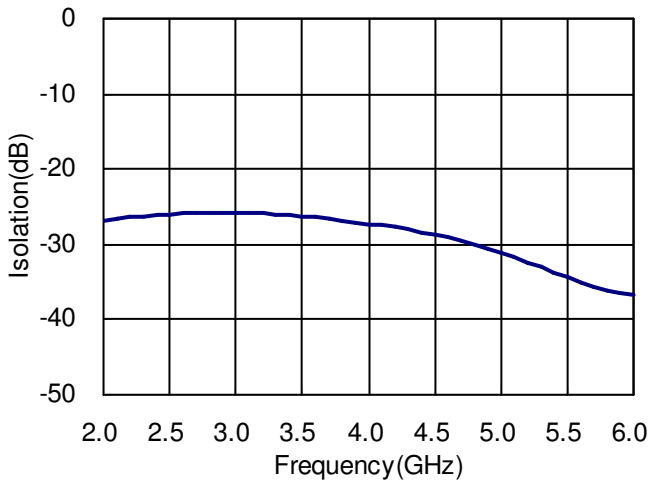
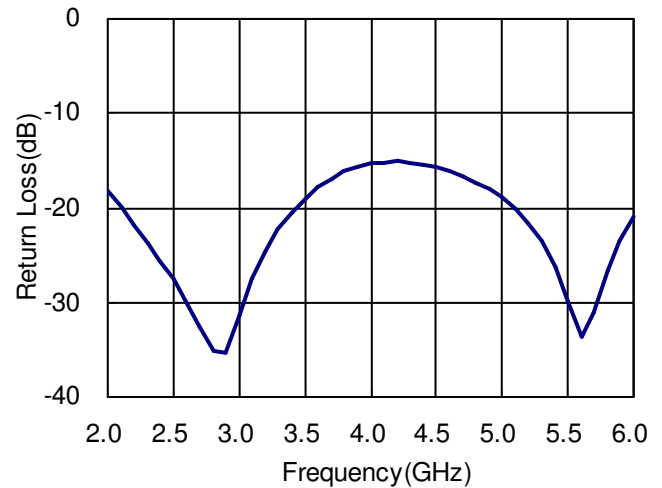
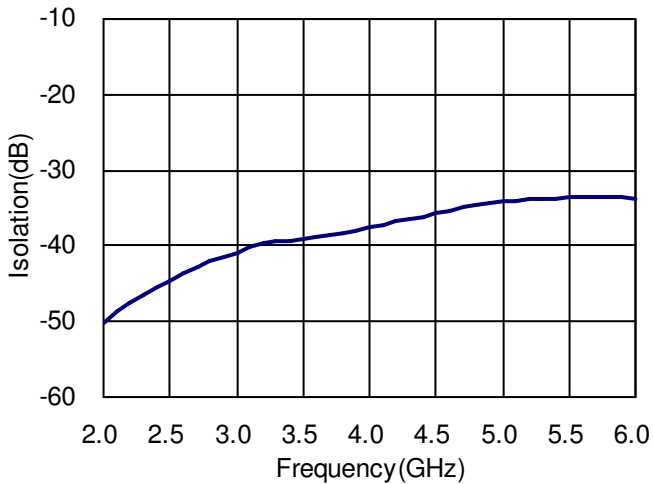
Note: All measurements made in a 50 ohm system with 0/+3.0V control voltages, unless otherwise specified.

Typical Performance Data with 8pF Capacitors @ +25 °C
Insertion Loss vs Frequency

Isolation(TX port to RX port) vs Frequency

Isolation(on port to off port) vs Frequency

Return Loss vs Frequency

Isolation(off port to off port) vs Frequency

Absolute Maximum Ratings

Parameter	Absolute Maximum
RF Input Power	+32 dBm @ +3V
Control Voltage	+6V
Operating Temperature	-40°C to +85°C
Storage Temperature	-65°C to +150°C

Logic Table for Switch On-Path

VC1	VC2	VC3	VC4	On-Path
0	1	0	1	ANT1-RX
0	1	1	0	ANT1-TX
1	0	0	1	ANT2-RX
1	0	1	0	ANT2-TX

Pin Out (Top View)

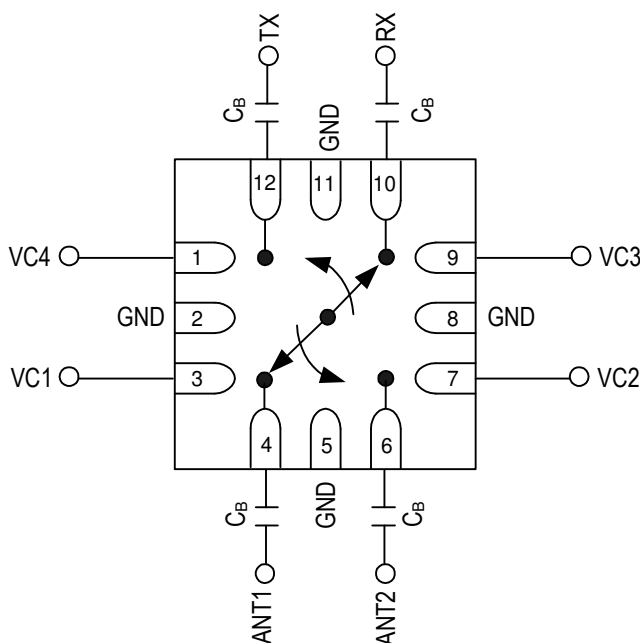

Note:

- '1' = +3V to +5V, '0' = 0V to +0.2V
- VC1 and VC2 are used for antenna selection, while VC3 and VC4 are used for TX/RX selection.

Note:

- DC blocking capacitors $C_B=8\text{pF}$ are required on all RF ports.
- Exposed pad in the bottom must be connected to ground by via holes.
- TX and RX ports can be used interchangeably.