

AXIAL LED LAMPS

Super Blue Axial With "Gull Wing" Lead

Part Number: AL-XB3361-F7

Package outlines & Re-flow Profile

■Reflow Temp/Time

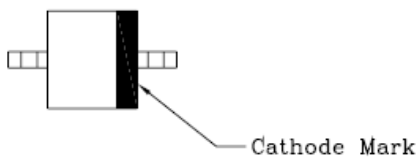
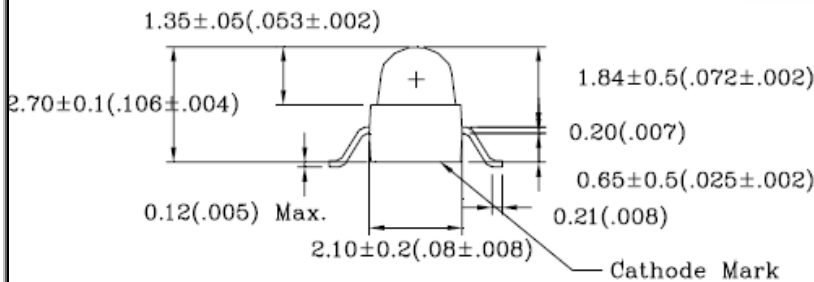
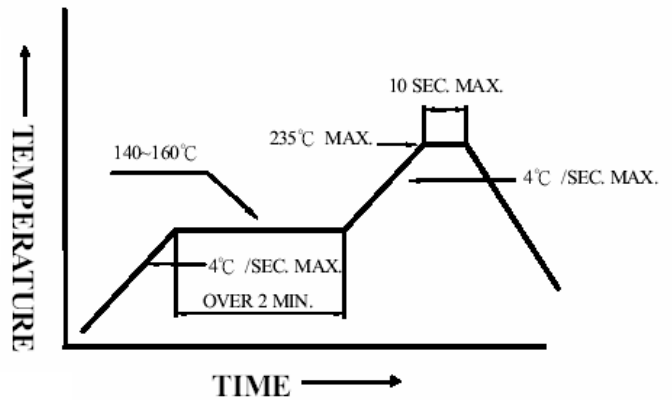
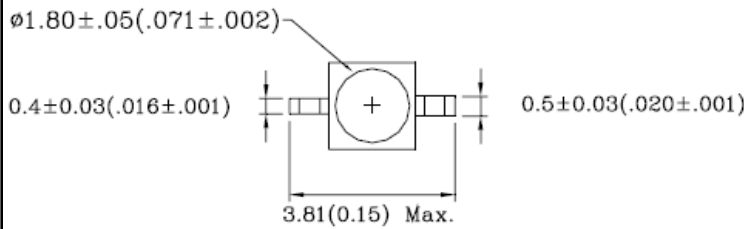

■Soldering iron

Basic spec is $\leq 5\text{sec}$ when 260°C . If temperature is higher, time should be shorter ($+10^\circ\text{C} \rightarrow -1\text{sec}$). Power dissipation of iron should be smaller than 15W, and temperatures should be controllable. Surface temperature of the device should be under 230°C .

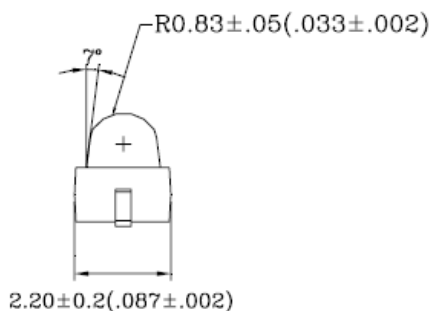

ITEM	MATERIALS
Resin (mold)	Epoxy
Lens color	Water Clear
Printed circuit board	BT
Dice	InGaN
Emitted color	Super Blue

NOTES:

- All dimensions are in millimeters (inches);
- Tolerances are $\pm 0.1\text{mm}$ (0.004inch) unless otherwise noted.

AXIAL LED LAMPS**Part Number: AL-XB3361-F7****ELECTRO-OPTICAL CHARACTERISTICS****(T_A=25°C)**

Parameter	Test Condition	Symbol	Value	Unit
Viewing angle at 50% I _v	I _F =10mA	2 θ 1/2	35	Deg
Forward voltage (Typ.)	I _F =20mA	V _F	2.80	V
(Max.)			3.20	
Luminous intensity (Min.)	I _F =20mA	I _v	28.0	mcd
(Typ.)			60.0	
Wavelength	I _F =20mA	λ _p	470	nm
		λ _d	470±5	
Spectral Line Half-Width	I _F =20mA	△λ	30	nm
Peak pulsing current (1/10 duty f=1kHz)		I _{FP}	100	mA

Absolute maximum ratings**(T_A=25°C)**

Parameter	Symbol	Value	Unit
Forward current	I _F	30	mA
Reverse voltage	V _R	5	V
Reverse current	I _R	100	μA
Power Dissipation	P _D	120	mW
Operating temperature range	Top	-25 ~+80	°C
Storage temperature range	Tstg	-30 ~+85	°C
Lead soldering temperature	260°C For 5 Seconds		

AXIAL LED LAMPS**Part Number: AL-XB3361-F7****Test items and results of reliability**

Classification	Test Item	Reference Standard	Test Conditions	Result
Endurance Test	Operation Life	MIL-STD-750:1026 MIL-STD-883:1005 JIS C 7021 :B-1	Connect with a power $I_f=20\text{mA}$ T_a =Under room temperature Test time=1,000hrs	0/20
	High Temperature High Humidity Storage	MIL-STD-202:103B JIS C 7021 :B-11	$T_a=+65^\circ\text{C}\pm 5^\circ\text{C}$ RH=90%-95% Test time=240hrs	0/20
	High Temperature Storage	MIL-STD-883:1008 JIS C 7021 :B-10	High $T_a=+85^\circ\text{C}\pm 5^\circ\text{C}$ Test time=1,000hrs	0/20
	Low Temperature Storage	JIS-C-7021 :B-12	Low $T_a=-35^\circ\text{C}\pm 5^\circ\text{C}$ Test time=1,000hrs	0/20
Environmental Test	Temperature Cycling	MIL-STD-202:107D MIL-STD-750:1051 MIL-STD-883:1010 JIS C 7021 :A-4	$-35^\circ\text{C} \sim +25^\circ\text{C} \sim +85^\circ\text{C} \sim +25^\circ\text{C}$ 60min 20min 60min 20min Test Time=5cycle	0/20
	Thermal Shock	MIL-STD-202:107D MIL-STD-750:1051 MIL-STD-883:1011	$-35^\circ\text{C}\pm 5^\circ\text{C} \sim +85^\circ\text{C}\pm 5^\circ\text{C}$ 20min 20min Test Time=10cycle	0/20
	Solder Resistance	MIL-STD-202:201A MIL-STD-750:2031 JIS C 7021 :A-1	Preheating : 140°C -160°C ,within 2 minutes. Operation heating : 235°C(Max.), within 10seconds. (Max.)	0/20

* Refer to reliability test standard specification for in this line.

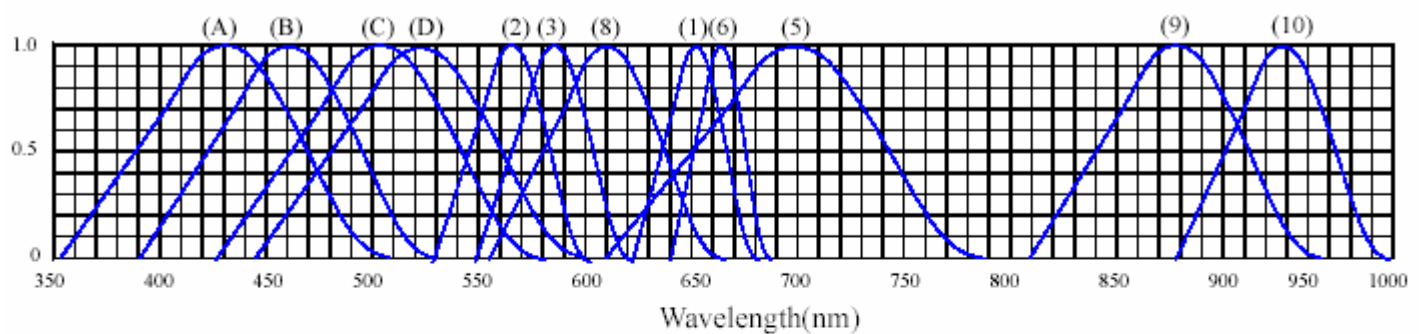
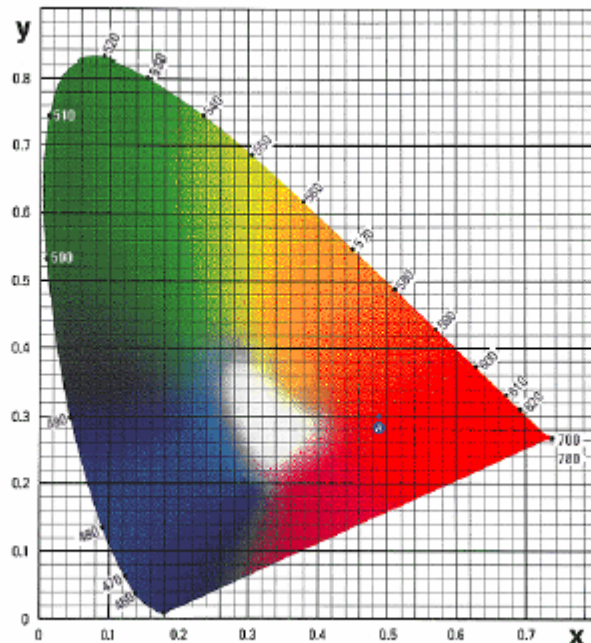
AXIAL LED LAMPS**Part Number: AL-XB3361-F7****Typical Optical-Electrical Characteristic Curves**◆ **TYPICAL ELECTRICAL-OPTICAL CHARACTERISTICS CURVES**RELATIVE INTENSITY VS. WAVELENGTH(λ_p)

- | | |
|---|----------------------------------|
| (1) GaAsP/GaAs 655nm/Red | (9)- GaAlAs 880nm |
| (2) GaP 568nm/ Yellow Green | (10)-GaAs/GaAs&GaAlAs/GaAs 940nm |
| (3) GaAsP/GaP 585nm/Yellow | (A)- GaN 430nm/Blue |
| (4) GaAsP/GaP 635nm/Orange & Hi-Eff Red | (B)- InGaN 470nm/Blue |
| (5) GaP 700nm/Bright Red | (C)- InGaN 502nm/Ultra Green |
| (6) GaAlAs/GaAs 660nm/Super Red | (D)- InGaN 523nm/Ultra Green |
| (8) GaAsP/GaP 610nm/Super Red | |

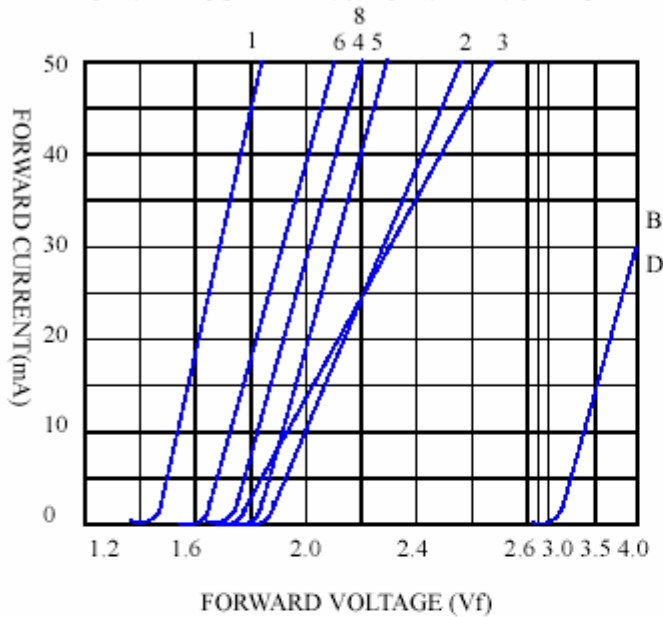
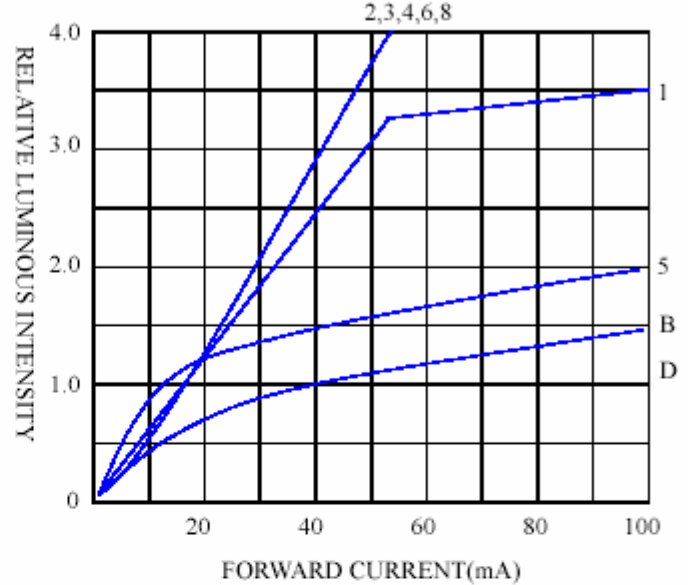
AXIAL LED LAMPS**Part Number: AL-XB3361-F7****Typical Optical-Electrical Characteristic Curves**◆ **CHARACTERISTICS DIAGRAMS****FORWARD CURRENT VS. FORWARD VOLTAGE****RELATIVE LUMINOUS INTENSITY VS. FORWARD CURRENT****FORWARD CURRENT VS. AMBIENT TEMPERATURE**