

**FEATURES**

**Operation from 400 MHz to 4000 MHz**  
**Noise figure of 0.8 dB at 900 MHz**  
 Including external input match  
**Gain of 20.0 dB at 900 MHz**  
**OIP3 of 37.7 dBm at 900 MHz**  
**P1dB of 22.0 dBm at 900 MHz**  
**Integrated bias control circuit**  
**Single supply operation from 3 V to 5 V**  
**Operating current of 26 mA at 3 V**  
**Small footprint LFCSP package**  
**Pin compatible with 17.5 dB gain ADL5523**

**FUNCTIONAL BLOCK DIAGRAM**

Figure 1.

**GENERAL DESCRIPTION**

The ADL5521 is a high performance GaAs pHEMT low-noise amplifier. It provides high gain and low noise figure for single down-conversion IF sampling receiver architectures as well as direct down conversion receivers. The ADL5521 also has low power consumption at 3 V.

The ADL5521 allows optimal noise matching without sacrificing significant gain matching. S11 of better than 6 dB can typically be achieved when matching for optimal noise.

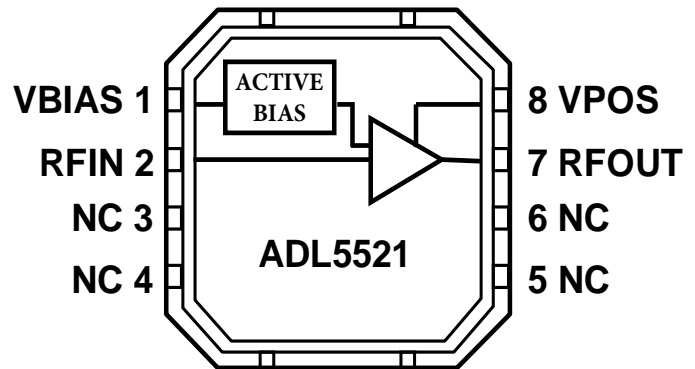
The ADL5521 amplifier comes in a compact, thermally enhanced, 3mm x 3mm LFCSP package and operates over the temperature range of -40°C to +85°C.

The ADL5523 is a companion part that offers a gain of 17.5 dB in a pin compatible package. A fully populated evaluation board is also available.

**Rev. PrC**

Information furnished by Analog Devices is believed to be accurate and reliable. However, no responsibility is assumed by Analog Devices for its use, nor for any infringements of patents or other rights of third parties that may result from its use. Specifications subject to change without notice. No license is granted by implication or otherwise under any patent or patent rights of Analog Devices. Trademarks and registered trademarks are the property of their respective owners.

AC Specifications.....4

AC Specifications.....5

AC Specifications (cont.).....6

AC Specifications (cont.).....7

De-Embedded S-Parameters,  $V_{POS} = 5V$  .....8

De-Embedded S-Parameters,  $V_{POS} = 5V$  (Cont.) .....9

De-Embedded S-Parameters,  $V_{POS} = 3V$  ..... 10

De-Embedded S-Parameters,  $V_{POS} = 3V$  (Cont.) ..... 11

Absolute Maximum Ratings..... 12

    ESD Caution..... 12

Pin Configuration And Functional Descriptions..... 13

Typical Performance Characteristics, 500MHz,  $V_{POS} = 5V$  ..... 14

Typical Performance Characteristics, 900MHz,  $V_{POS} = 5V$  ..... 15

Typical Performance Characteristics, 1300MHz,  $V_{POS} = 5V$  ..... 16

Typical Performance Characteristics, 1950MHz,  $V_{POS} = 5V$  ..... 17

Typical Performance Characteristics, 2140MHz,  $V_{POS} = 5V$  ..... 18

Typical Performance Characteristics, 2600MHz,  $V_{POS} = 5V$  ..... 19

Typical Performance Characteristics, 3500MHz,  $V_{POS} = 5V$  ..... 20

Typical Performance Characteristics, 500MHz,  $V_{POS} = 3V$  ..... 21

Typical Performance Characteristics, 900MHz,  $V_{POS} = 3V$  ..... 22

Typical Performance Characteristics, 1300MHz,  $V_{POS} = 3V$  ..... 23

Typical Performance Characteristics, 1950MHz,  $V_{POS} = 3V$  ..... 24

Typical Performance Characteristics, 2140MHz,  $V_{POS} = 3V$  ..... 25

Typical Performance Characteristics, 2600MHz,  $V_{POS} = 3V$  ..... 26

Typical Performance Characteristics, 3500MHz,  $V_{POS} = 3V$  ..... 27

Typical DC Performance Characteristics ..... 28

Source Pull Circles, Gain and Noise Figure,  $V_{POS} = 5V$  ..... 30

LOAD Pull Circles, Gain and IP3,  $V_{POS} = 5V$  ..... 31

Source Pull Circles, Noise Figure,  $V_{POS} = 3V$  ..... 32

LOAD Pull Circles, Gain and IP3,  $V_{POS} = 3V$  ..... 33

Tuning the ADL5521/23 Eval Board for Optimal Noise Figure..... 34

    Tuning S22..... 34

Tuning the LNA Input for Optimal Gain..... 37

Tuning the LNA Input for Optimal Noise Figure ..... 37

S11 Parameters of ADL5521,23 with S22 Matched ..... 38

Example of Optimal Noise Matching at 850MHz..... 41

Outline Dimensions ..... 45

Ordering Guide..... 45

## AC SPECIFICATIONS

T = 25°C, R<sub>BIAS</sub> = 3.3KΩ, parameters include matching circuit, matched for optimal noise, unless otherwise noted

Table 1.

Parameter	Conditions	3V			5V			Unit
		Min	Typ	Max	Min	Typ	Max	
<b>Frequency = 500MHz</b>								
Gain (S <sub>21</sub> )			21.6			22.5		dB
Gain Flatness	In the [450 – 550] frequency band		TBD			TBD		dB/MHz
Gain vs. Temperature -40° to +85 C°			TBD			TBD		dB/degC
Noise Figure	R <sub>BIAS</sub> = 3.3KΩ		1.0			1.0		dB
	R <sub>BIAS</sub> = 5.2KΩ		0.9			0.9		
Output IP3	Two tones, each 0dBm out		29.0			37.8		dBm
Output 1 dB Compression Point			16.8			22.0		dBm
Input return loss (S <sub>11</sub> )			-7.5			-8.6		dB
Output return loss (S <sub>22</sub> )			-16.9			-16.4		dB
Isolation (S <sub>12</sub> )			-26.9			-27.9		dB
<b>Frequency = 900MHz</b>								
Gain (S <sub>21</sub> )			19.7			20		dB
Gain Flatness	In the [850 – 950] frequency band		TBD			TBD		dB/MHz
Gain vs. Temperature -40° to +85 C°			TBD			TBD		dB/degC
Noise Figure	R <sub>BIAS</sub> = 3.3KΩ		0.9			0.9		dB
	R <sub>BIAS</sub> = 5.2KΩ		0.9			0.8		
Output IP3	Two tones, each 0dBm out		27.8			37.7		dBm
Output 1 dB Compression Point			16.8			22.0		dBm
Input return loss (S <sub>11</sub> )			-7.6			-8.5		dB
Output return loss (S <sub>22</sub> )			-16.3			17.1		dB
Isolation (S <sub>12</sub> )			-24.4			25.5		dB

## AC SPECIFICATIONS

T = 25°C, R<sub>BIAS</sub> = 3.3KΩ, parameters include matching circuit, matched for optimal noise, unless otherwise noted

Table 2.

Parameter	Conditions	3V			5V			Unit
		Min	Typ	Max	Min	Typ	Max	
<b>Frequency = 1300MHz</b>								
Gain (S <sub>21</sub> )			18.1			18.4		dB
Gain Flatness	In the [1200 – 1300] frequency band		TBD			TBD		dB/MHz
Gain vs. Temperature - 40° to +85 C°			TBD			TBD		dB/degC
Noise Figure	R <sub>BIAS</sub> = 3.3KΩ		0.9			0.9		dB
	R <sub>BIAS</sub> = 5.2KΩ		0.8			0.8		
Output IP3	Two tones, each 0dBm out		29.7			35.6		dBm
Output 1 dB Compression Point			16.2			21.9		dBm
Input return loss (S <sub>11</sub> )			-6.3			-7.9		dB
Output return loss (S <sub>22</sub> )			-16.8			-16.2		dB
Isolation (S <sub>12</sub> )			-22.3			-23.3		dB
<b>Frequency = 1950MHz</b>								
Gain (S <sub>21</sub> )			14.9			15.4		dB
Gain Flatness	In the [1920 – 1980] frequency band		TBD			0.015		dB/MHz
Gain vs. Temperature - 40° to +85 C°			TBD			0.018		dB/degC
Noise Figure	R <sub>BIAS</sub> = 3.3KΩ		0.9			0.9		dB
	R <sub>BIAS</sub> = 5.2KΩ		0.8			0.8		
Output IP3	Two tones, each 0dBm out		29.4			35.5		dBm
Output 1 dB Compression Point			16.0			21.6		dBm
Input return loss (S <sub>11</sub> )			-8.1			-8.9		dB
Output return loss (S <sub>22</sub> )			-25.7			-29.9		dB
Isolation (S <sub>12</sub> )			-21.2			-21.7		dB

## AC SPECIFICATIONS (CONT.)

T = 25°C, R<sub>BIAS</sub> = 3.3KΩ, parameters include matching circuit, matched for optimal noise, unless otherwise noted

Table 3.

Parameter	Conditions	3V			5V			Unit
		Min	Typ	Max	Min	Typ	Max	
<b>Frequency = 2140MHz</b>								
Gain (S <sub>21</sub> )			14.4			14.8		dB
Gain Flatness	In the [2110 – 2170] frequency band		TBD			TBD		dB/MHz
Gain vs. Temperature - 40° to +85 C°			TBD			TBD		dB/degC
Noise Figure	R <sub>BIAS</sub> = 3.3KΩ		0.9			0.9		dB
	R <sub>BIAS</sub> = 5.2KΩ		0.8			0.8		
Output IP3	Two tones, each 0dBm out		31.1			35.8		dB
Output 1 dB Compression Point			16.1			21.5		dBm
Input return loss (S <sub>11</sub> )			-7.8			-8.5		dB
Output return loss (S <sub>22</sub> )			-32.1			-35.6		dB
Isolation (S <sub>12</sub> )			-20.6			-21.1		dB
<b>Frequency = 2600MHz</b>								
Gain (S <sub>21</sub> )			12.1			12.5		dB
Gain Flatness	In the [2500 – 2700] frequency band		TBD			TBD		dB/MHz
Gain vs. Temperature - 40° to +85 C°			TBD			TBD		dB/degC
Noise Figure	R <sub>BIAS</sub> = 3.3KΩ		0.9			0.9		dB
	R <sub>BIAS</sub> = 5.2KΩ		0.8			0.8		
Output IP3	Two tones, each 0dBm out		31.0			35.5		dBm
Output 1 dB Compression Point			16.0			21.1		dBm
Input return loss (S <sub>11</sub> )			-6.1			-6.4		dB
Output return loss (S <sub>22</sub> )			-15.7			-15.8		dB
Isolation (S <sub>12</sub> )			-20.2			-20.6		dB

**AC SPECIFICATIONS (CONT.)**

T = 25°C, R<sub>BIAS</sub> = 3.3KΩ, parameters include matching circuit, matched for optimal noise, unless otherwise noted

Table 4.

Parameter	Conditions	3V			5V			Unit
		Min	Typ	Max	Min	Typ	Max	
<b>Frequency = 3500MHz</b>								
Gain (S <sub>21</sub> )			10.0			10.5		dB
Gain Flatness	In the [3400 – 3600] frequency band		TBD			TBD		dB/MHz
Gain vs. Temperature - 40° to +85 C°			TBD			TBD		dB/degC
Noise Figure	R <sub>BIAS</sub> = 3.3KΩ		1.1			1.1		dB
	R <sub>BIAS</sub> = 5.2KΩ		1.1			1.1		
Output IP3	Two tones, each 0dBm out		28.1			33		dBm
Output 1 dB Compression Point			15.0			20.2		dBm
Input return loss (S <sub>11</sub> )			-8.6			-9.1		dB
Output return loss (S <sub>22</sub> )			-17.1			-17.1		dB
Isolation (S <sub>12</sub> )			-18.0			-18.3		dB

**DC Specifications**

Parameter	Conditions	3V			5V			Unit
		Min	Typ	Max	Min	Typ	Max	
Current Consumption	R <sub>BIAS</sub> = 3.3KΩ		36			65		ma
	R <sub>BIAS</sub> = 5.2KΩ		TBD			48		

DE-EMBEDDED S-PARAMETERS,  $V_{POS} = 5V$ 

Frequency (GHz)	S <sub>11</sub>	S <sub>11</sub>	S <sub>12</sub>	S <sub>12</sub>	S <sub>21</sub>	S <sub>21</sub>	S <sub>22</sub>	S <sub>22</sub>	K
	(Mag)	(Angle)	(Mag)	(Angle)	(Mag)	(Angle)	(Mag)	(Angle)	
0.05									
0.125									
0.25									
0.375									
0.5									
0.625									
0.75									
0.875									
1.0									
1.125									
1.25									
1.375									
1.5									
1.625									
1.75									
1.875									
2.0									
2.125									
2.25									
2.375									
2.5									
2.625									
2.75									
2.875									
3.0									
3.125									



**DE-EMBEDDED S-PARAMETERS,  $V_{POS} = 5V$  (CONT.)**

Frequency (GHz)	S <sub>11</sub> (Mag)	S <sub>11</sub> (Angle)	S <sub>12</sub> (Mag)	S <sub>12</sub> (Angle)	S <sub>21</sub> (Mag)	S <sub>21</sub> (Angle)	S <sub>22</sub> (Mag)	S <sub>22</sub> (Angle)	K
3.125									
3.25									
3.375									
3.5									
3.625									
3.75									
3.875									
4.0									

DE-EMBEDDED S-PARAMETERS,  $V_{POS} = 3V$ 

Frequency (GHz)	S <sub>11</sub>	S <sub>11</sub>	S <sub>12</sub>	S <sub>12</sub>	S <sub>21</sub>	S <sub>21</sub>	S <sub>22</sub>	S <sub>22</sub>	K
	(Mag)	(Angle)	(Mag)	(Angle)	(Mag)	(Angle)	(Mag)	(Angle)	
0.05									
0.125									
0.25									
0.375									
0.5									
0.625									
0.75									
0.875									
1.0									
1.125									
1.25									
1.375									
1.5									
1.625									
1.75									
1.875									
2.0									
2.125									
2.25									
2.375									
2.5									
2.625									
2.75									
2.875									
3.0									
3.125									

**DE-EMBEDDED S-PARAMETERS,  $V_{POS} = 3V$  (CONT.)**

Frequency (GHz)	S <sub>11</sub> (Mag)	S <sub>11</sub> (Angle)	S <sub>12</sub> (Mag)	S <sub>12</sub> (Angle)	S <sub>21</sub> (Mag)	S <sub>21</sub> (Angle)	S <sub>22</sub> (Mag)	S <sub>22</sub> (Angle)	K
3.125									
3.25									
3.375									
3.5									
3.625									
3.75									
3.875									
4.0									

## ABSOLUTE MAXIMUM RATINGS

Table 5

Parameter	Rating
Supply Voltage, $V_{POS}$	5.5 V
Max RF Input Level	+20dBm
Internal Power Dissipation	TBD mW
$\theta_{JA}$ (Exposed paddle soldered down)	TBD mW
$\theta_{JA}$ (Exposed paddle not soldered down)	TBD°C/W
$\theta_{JC}$ (At exposed paddle)	TBD°C/W
Maximum Junction Temperature	TBD°C/W
Operating Temperature Range	TBD°C
Storage Temperature Range	-40°C to +85°C
Lead Temperature Range (Soldering 60 sec)	-65°C to +150°C

Stresses above those listed under Absolute Maximum Ratings may cause permanent damage to the device. This is a stress rating only; functional operation of the device at these or any other conditions above those listed in the operational sections of this specification is not implied. Exposure to absolute maximum rating conditions for extended periods may affect device reliability.

### ESD CAUTION

ESD (electrostatic discharge) sensitive device. Electrostatic charges as high as 4000 V readily accumulate on the human body and test equipment and can discharge without detection. Although this product features proprietary ESD protection circuitry, permanent damage may occur on devices subjected to high energy electrostatic discharges. Therefore, proper ESD precautions are recommended to avoid performance degradation or loss of functionality.



## PIN CONFIGURATION AND FUNCTIONAL DESCRIPTIONS

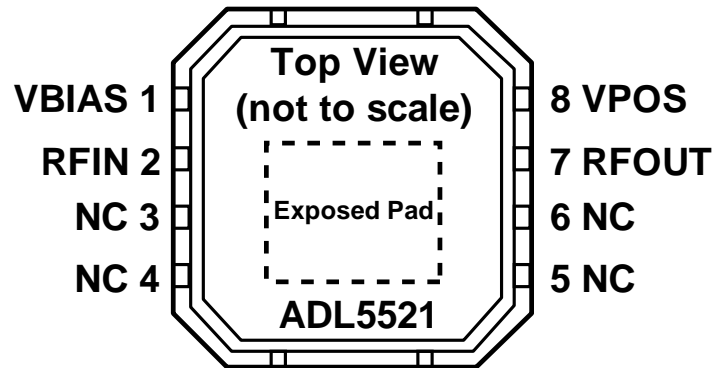

Figure 2. 8-Lead LFCSP

Table 3. Pin Function Descriptions- 8Lead CSP

Pin No.	Mnemonic	Description
1	VBIAS	<b>Bias:</b> Internal DC bias. This pin should be connected to VPOS through a 3.3K $\Omega$ resistor for optimum performance
2	RFIN	<b>RF Input:</b> Input to LNA
3,4,5,6	NC	<b>NC:</b> No internal connection
7	RFOUT	<b>RF Output:</b> Must be AC-coupled.
8	VPOS	<b>Supply:</b> VDD bias needs to be bypassed to ground using low-inductance capacitors. The recommended configuration is for the output matching to be done on this pin. See schematics in applications section.
Exposed pad	EP	<b>Exposed Paddle:</b> Connect to a low impedance ground plane

# TYPICAL PERFORMANCE CHARACTERISTICS, 500MHZ, VPOS = 5V

Matched for optimal noise figure, external matching circuit included.



Figure 3. Typical S Parameters, Log magnitude

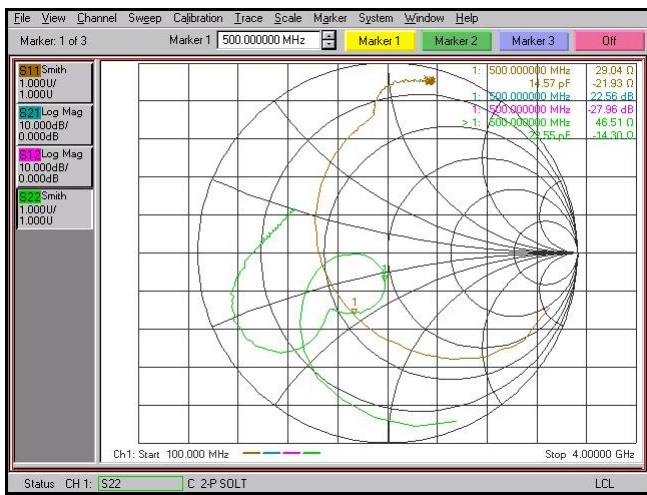

Figure 4. S11 and S22, Smith Chart

Figure 5. Gain, P1dB, OIP3 vs. Frequency

Figure 6. Distribution of Noise Figure for Five Parts

Figure 7. Output Power and Gain vs. Temperature

Figure 8. OIP3 vs. Output Power, Temperature and Frequency

# TYPICAL PERFORMANCE CHARACTERISTICS, 900MHZ, VPOS = 5V

Matched for optimal noise figure, external matching circuit included.

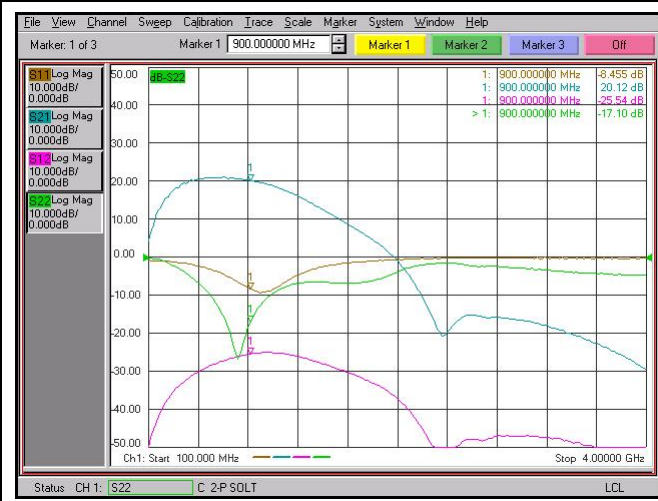

Figure 9. Typical S Parameters, Log magnitude

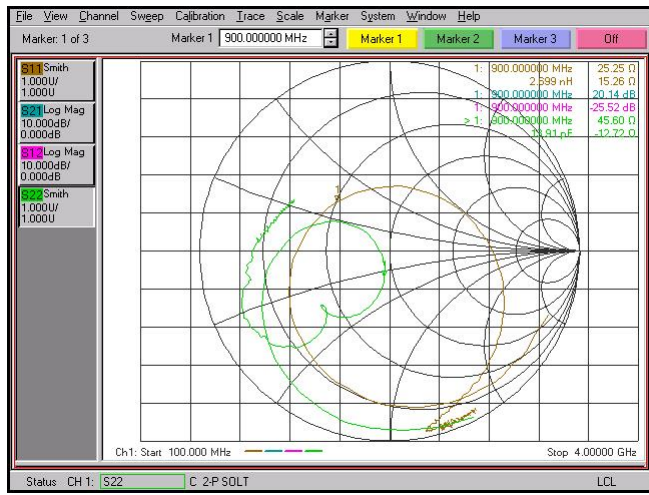

Figure 10. S11 and S22, Smith Chart

Figure 11. Gain, P1dB, OIP3 vs. Frequency

Figure 12. Distribution of Noise Figure for Five Parts

Figure 13. Output Power and Gain vs. Temperature

Figure 14. OIP3 vs. Output Power, Temperature and Frequency

# TYPICAL PERFORMANCE CHARACTERISTICS, 1300MHZ, VPOS = 5V

Matched for optimal noise figure, external matching circuit included.



Figure 15. Typical S Parameters, Log magnitude

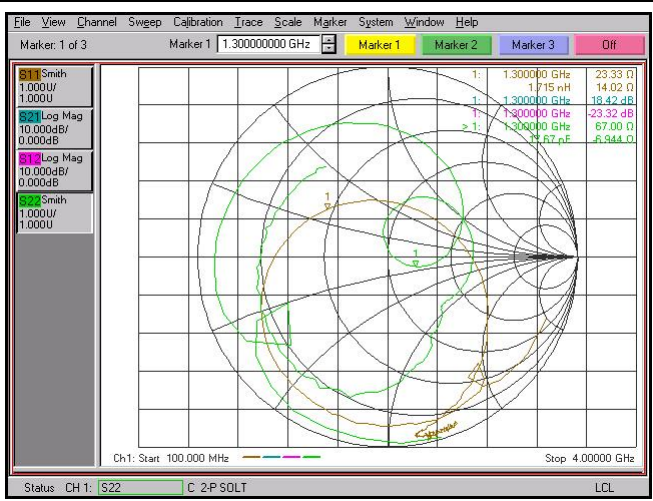

Figure 16. S11 and S22, Smith Chart

Figure 17. Gain, P1dB, OIP3 vs. Frequency

Figure 18. Distribution of Noise Figure for Five Parts

Figure 19. Output Power and Gain vs. Temperature

Figure 20. O IP3 vs. Output Power, Temperature and Frequency



# TYPICAL PERFORMANCE CHARACTERISTICS, 1950MHZ, VPOS = 5V

Matched to optimal noise figure, external matching circuit included.



Figure 21. Typical S Parameters, Log magnitude

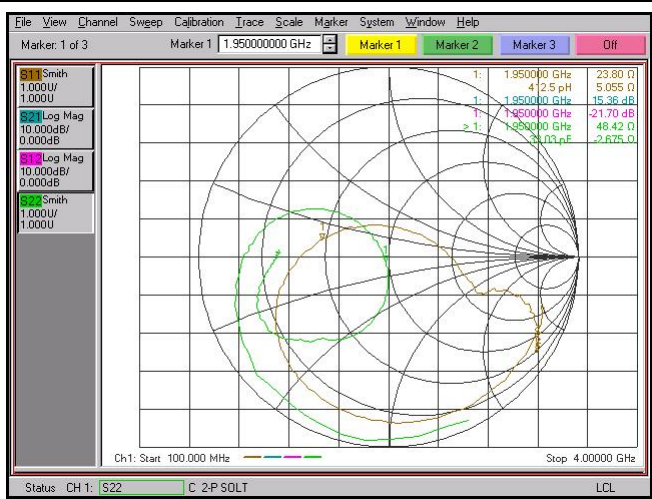

Figure 22. S11 and S22, Smith Chart

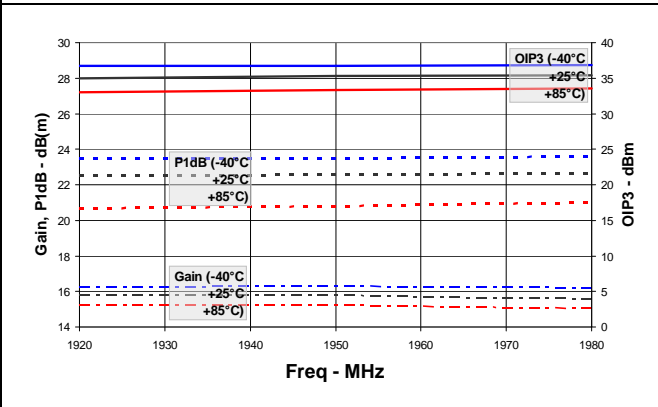

Figure 23. Gain, P1dB, OIP3 vs. Frequency

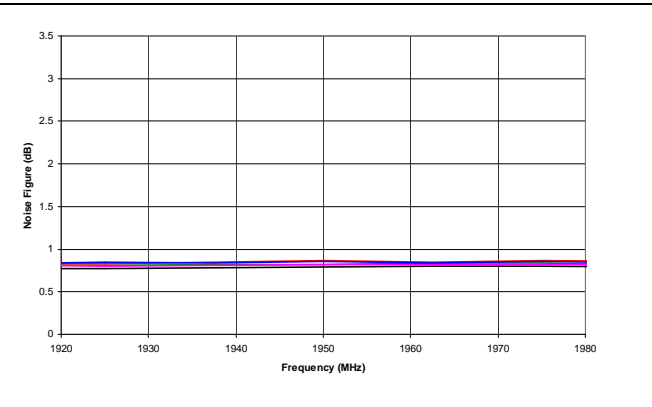

Figure 24. Distribution of Noise Figure for Five Parts

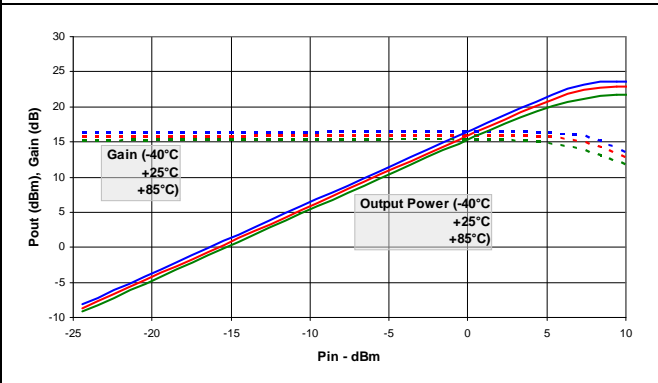

Figure 25. Output Power and Gain vs. Temperature

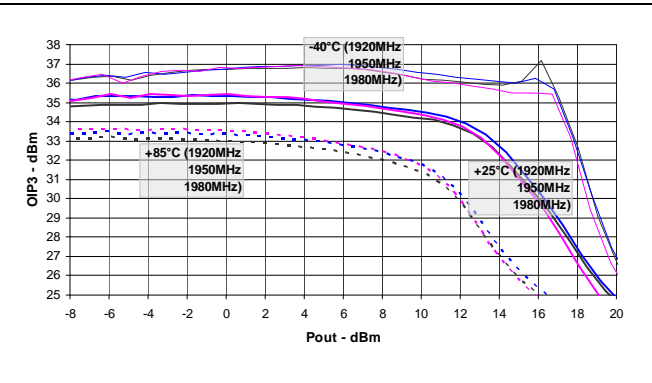

Figure 26. OIP3 vs. Output Power, Temperature and Frequency

# TYPICAL PERFORMANCE CHARACTERISTICS, 2140MHZ, VPOS = 5V

Matched for optimal noise figure, external matching circuit included.

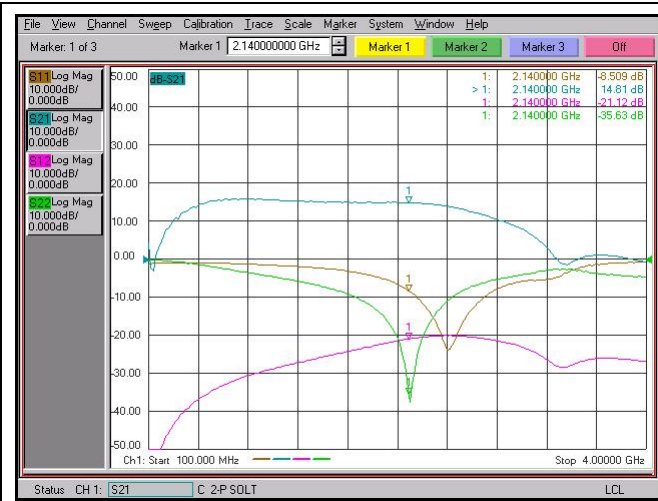

Figure 27. Typical S Parameters, Log magnitude

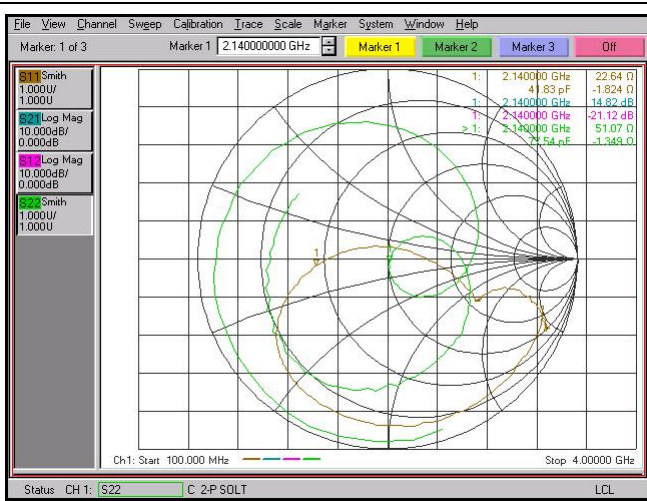

Figure 28. S11 and S22, Smith Chart

Figure 29. Gain, P1dB, OIP3 vs. Frequency

Figure 30. Distribution of Noise Figure for Five Parts

Figure 31. Output Power and Gain vs. Temperature

Figure 32. O IP3 vs. Output Power, Temperature and Frequency

# TYPICAL PERFORMANCE CHARACTERISTICS, 2600MHZ, VPOS = 5V

Matched for optimal noise figure, external matching circuit included.

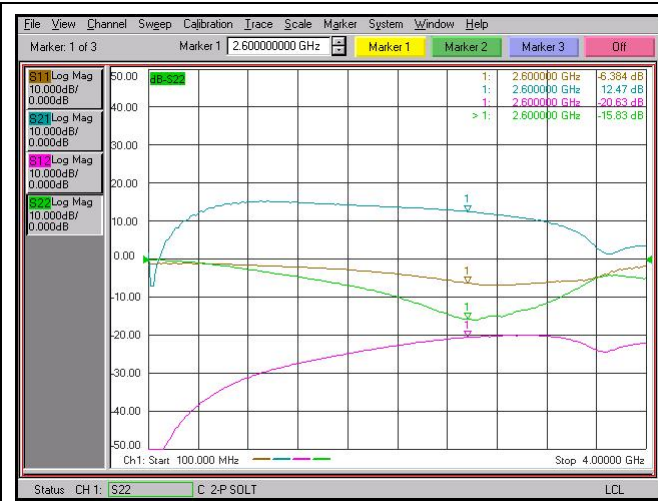

Figure 33. Typical S Parameters, Log magnitude

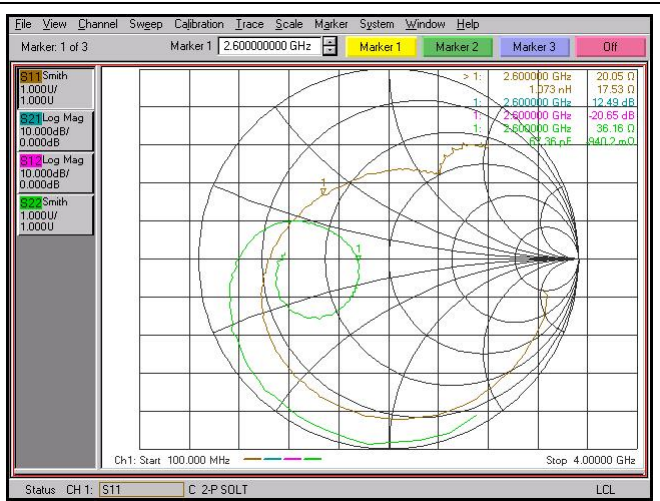

Figure 34. S11 and S22, Smith Chart

Figure 35. Gain, P1dB, OIP3 vs. Frequency

Figure 36. Distribution of Noise Figure for Five Parts

Figure 37. Output Power and Gain vs. Temperature

Figure 38. O IP3 vs. Output Power, Temperature and Frequency

# TYPICAL PERFORMANCE CHARACTERISTICS, 3500MHZ, VPOS = 5V

Matched for optimal noise figure, external matching circuit included.



Figure 39. Typical S Parameters, Log magnitude

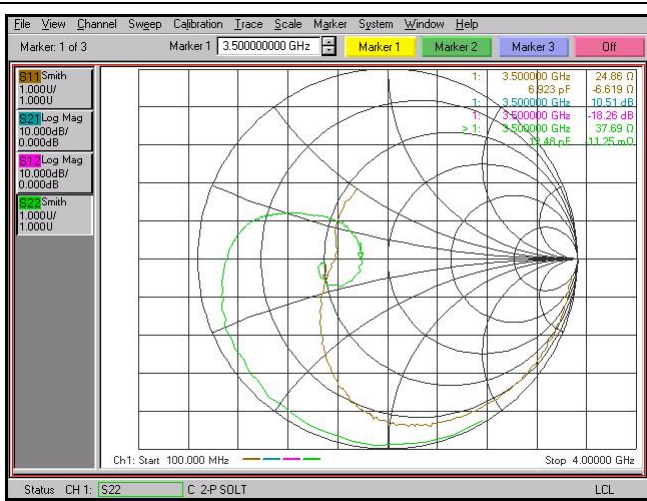

Figure 40. S11 and S22, Smith Chart

Figure 41. Gain, P1dB, OIP3 vs. Frequency

Figure 42. Distribution of Noise Figure for Five Parts

Figure 43. Output Power and Gain vs. Temperature

Figure 44. O IP3 vs. Output Power, Temperature and Frequency

# TYPICAL PERFORMANCE CHARACTERISTICS, 500MHZ, VPOS = 3V

Matched for optimal noise figure, external matching circuit included.



Figure 45. Typical S Parameters, Log magnitude

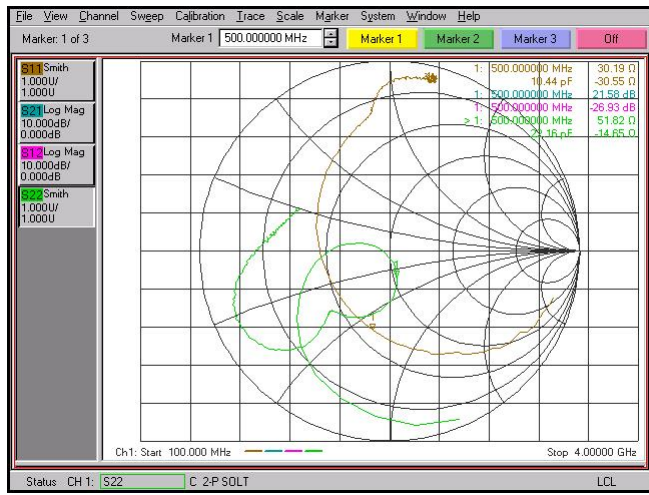

Figure 46. S11 and S22, Smith Chart

Figure 47. Gain, P1dB, OIP3 vs. Frequency

Figure 48. Distribution of Noise Figure for Five Parts

Figure 49. Output Power and Gain vs. Temperature

Figure 50. O IP3 vs. Output Power, Temperature and Frequency

# TYPICAL PERFORMANCE CHARACTERISTICS, 900MHZ, VPOS = 3V

Matched for optimal noise figure, external matching circuit included.

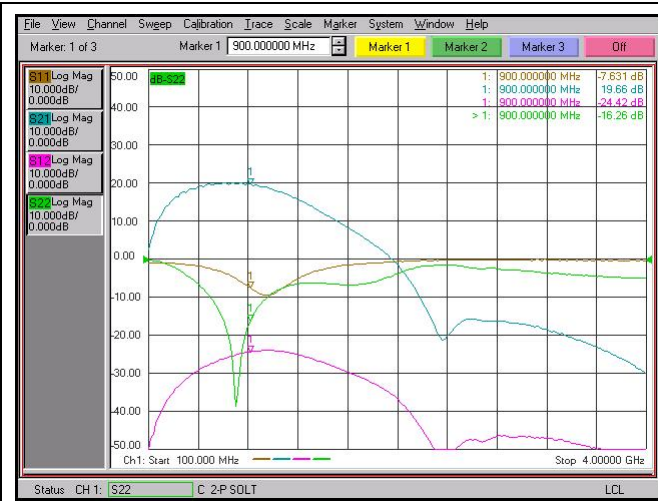

Figure 51. Typical S Parameters, Log magnitude

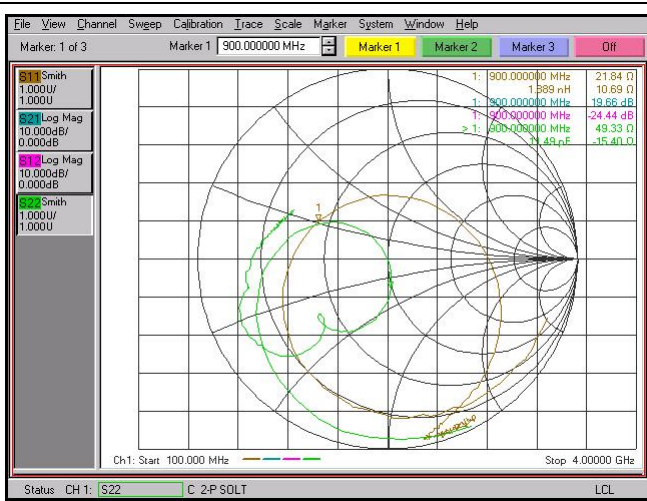

Figure 52. S11 and S22, Smith Chart

Figure 53. Gain, P1dB, OIP3 vs. Frequency

Figure 54. Distribution of Noise Figure for Five Parts

Figure 55. Output Power and Gain vs. Temperature

Figure 56. O IP3 vs. Output Power, Temperature and Frequency

# TYPICAL PERFORMANCE CHARACTERISTICS, 1300MHZ, VPOS = 3V

Matched for optimal noise figure, external matching circuit included.



Figure 57. Typical S Parameters, Log magnitude

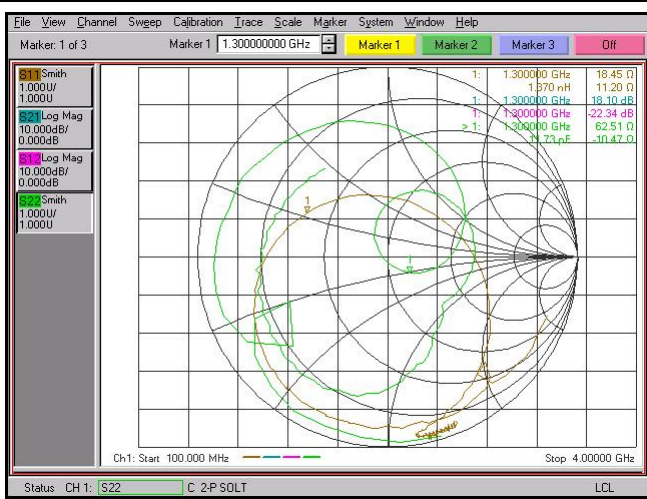

Figure 58. S11 and S22, Smith Chart

Figure 59. Gain, P1dB, OIP3 vs. Frequency

Figure 60. Distribution of Noise Figure for Five Parts

Figure 61. Output Power and Gain vs. Temperature

Figure 62. OIP3 vs. Output Power, Temperature and Frequency

## TYPICAL PERFORMANCE CHARACTERISTICS, 1950MHZ, VPOS = 3V

Matched for optimal noise figure, external matching circuit included.



Figure 63. Typical S Parameters, Log magnitude

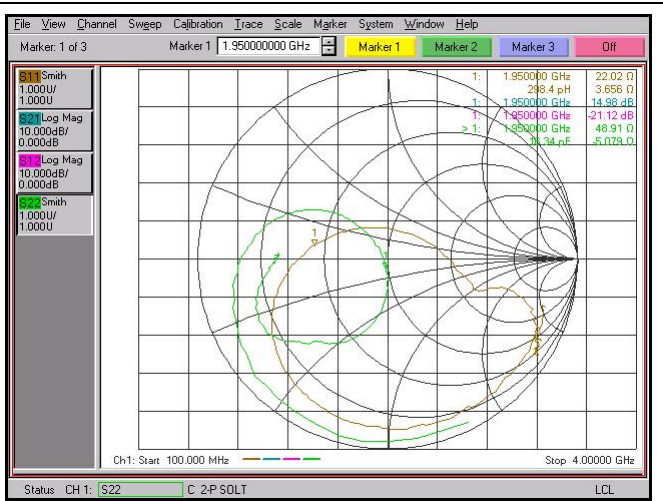

Figure 64. S11 and S22, Smith Chart

Figure 65. Gain, P1dB, OIP3 vs. Frequency

Figure 66. Distribution of Noise Figure for Five Parts

Figure 67. Output Power and Gain vs. Temperature

Figure 68. O IP3 vs. Output Power, Temperature and Frequency



## TYPICAL PERFORMANCE CHARACTERISTICS, 2140MHZ, VPOS = 3V

Matched for optimal noise figure, external matching circuit included.

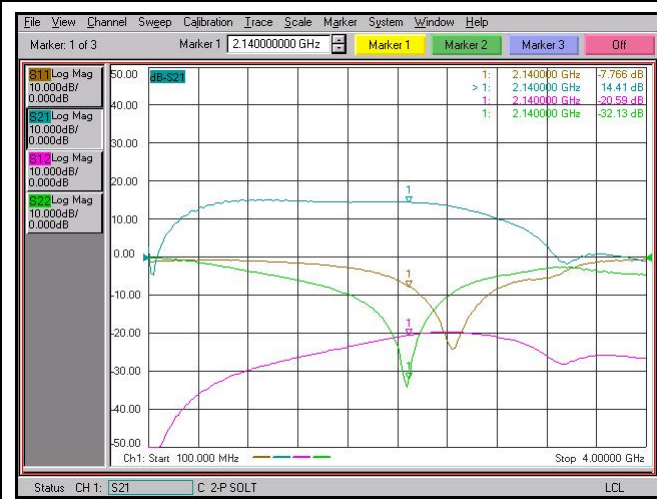

Figure 69. Typical S Parameters, Log magnitude

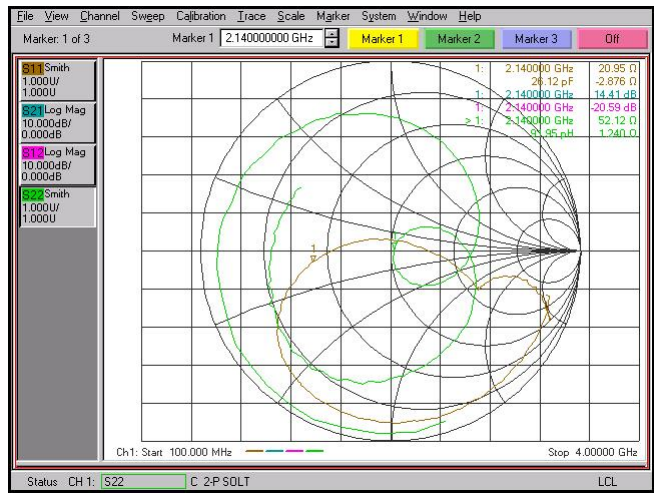

Figure 70. S11 and S22, Smith Chart

Figure 71. Gain, P1dB, OIP3 vs. Frequency

Figure 72. Distribution of Noise Figure for Five Parts

Figure 73. Output Power and Gain vs. Temperature

Figure 74. O IP3 vs. Output Power, Temperature and Frequency

# TYPICAL PERFORMANCE CHARACTERISTICS, 2600MHZ, VPOS = 3V

Matched for optimal noise figure, external matching circuit included.

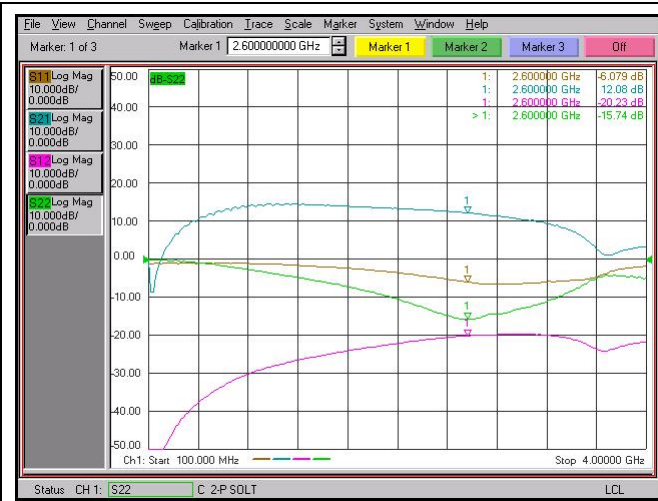

Figure 75. Typical S Parameters, Log magnitude

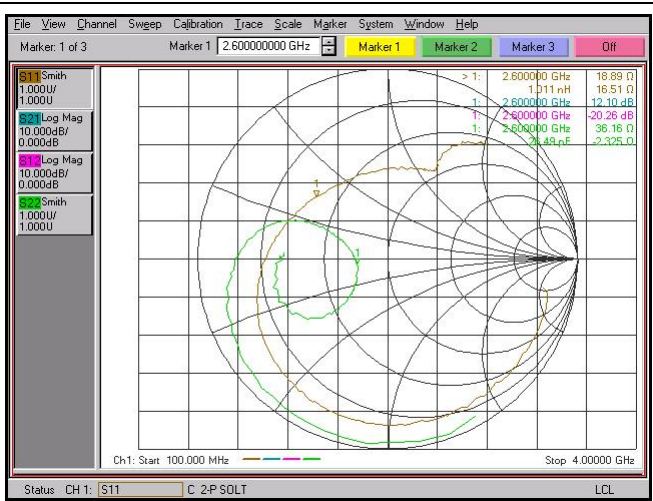

Figure 76. S11 and S22, Smith Chart

Figure 77. Gain, P1dB, OIP3 vs. Frequency

Figure 78. Distribution of Noise Figure for Five Parts

Figure 79. Output Power and Gain vs. Temperature

Figure 80. O IP3 vs. Output Power, Temperature and Frequency

# TYPICAL PERFORMANCE CHARACTERISTICS, 3500MHZ, VPOS = 3V

Matched for optimal noise figure, external matching circuit included.

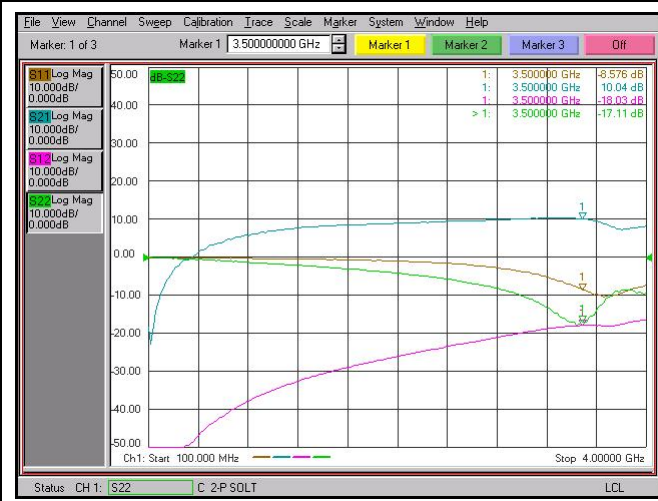

Figure 81. Typical S Parameters, Log magnitude

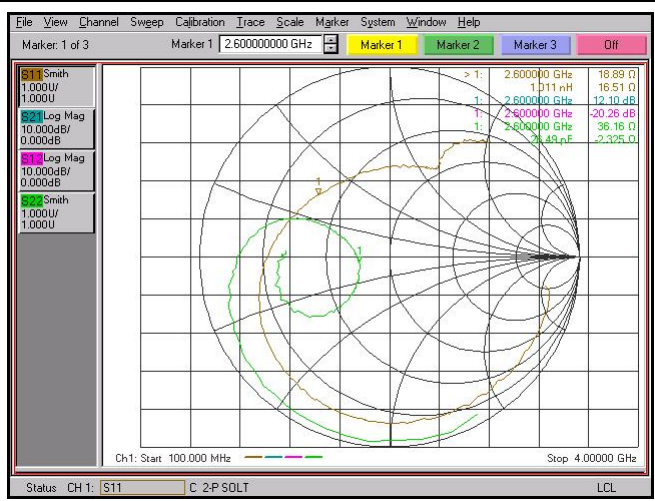

Figure 82. S11 and S22, Smith Chart

Figure 83. Gain, P1dB, OIP3 vs. Frequency

Figure 84. Distribution of Noise Figure for Five Parts

Figure 85. Output Power and Gain vs. Temperature

Figure 86. O IP3 vs. Output Power, Temperature and Frequency

### TYPICAL DC PERFORMANCE CHARACTERISTICS

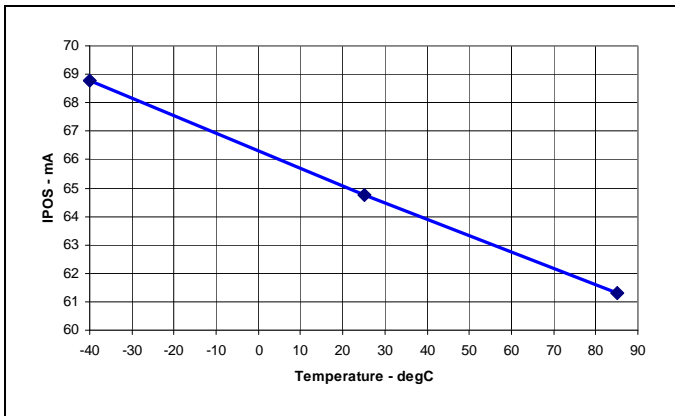
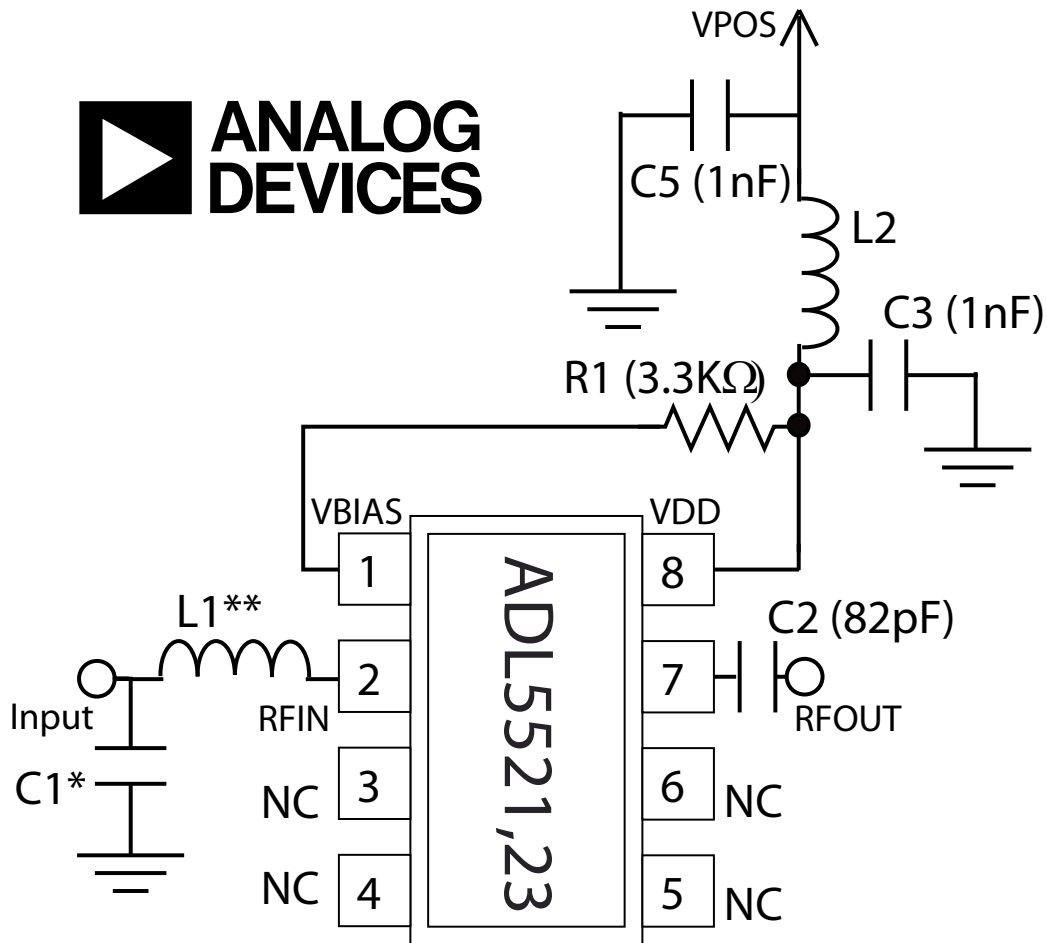

Figure 87. ADL5521 Current vs. Temperature, VPOS = 5V



note - ground is through thermal pad  
 \*Murata-Erie multilayer ceramic cap  
 \*\*Coilcraft High Q Surface Mount Inductor

Figure 88. LNA Eval Board Schematic.

Table 6. Recommended Components and Positions of Matching Components for Basic Connections, Tuned for Optimal Noise

Frequency	C1	C2	C3	C4	C5	L1	L2	TR1(mm)	TR2(mm)	R1	
500MHz	open	10nF	220pF	82pF	3.3KΩ	9nH	12nH	0	0	3.3KΩ	
900 MHz	2.4pF					open	8.2nH	3.4nH	0		0
1300 MHz	2.7pF					150pf	3.4nH	0Ω	0		7.5 x 0.5
1950 MHz	1.3pF					1.1nH	0Ω	4 x 0.5	3.5 x 0.5		
2140 MHz	1.3pf					1nF	1.1nH	0Ω	4.5 x 0.5		3.0 x 0.5
2600 MHz	1.3pf					1.3nH	0Ω	5 x 0.5	2.5 x 0.5		
3500 MHz	0.5pf					1.2nf	2.4pf*	0Ω	6.5 x 0.5		1x 0.5

\*Capacitor, not inductor, used to match at 3500MHz

**SOURCE PULL CIRCLES, GAIN AND NOISE FIGURE,  $V_{PDS} = 5V$** 

<i>Figure 89. Noise Contours for 500MHz Matching Components</i>	<i>Figure 90. Noise Contours for 2140MHz Matching Components</i>
<i>Figure 91. Noise Contours for 900MHz Matching Components</i>	<i>Figure 92. Noise Contours for 2600MHz Matching Components</i>
<i>Figure 93. Noise Contours for 1300MHz Matching Components</i>	<i>Figure 94. Noise Contours for 3500MHz Matching Components</i>
<i>Figure 95. Noise Contours for 1950MHz Matching Components</i>	

**LOAD PULL CIRCLES, GAIN AND IP3,  $V_{POS} = 5V$**

<i>Figure 96. IP3 and Gain Contours for 500MHz Matching Components</i>	<i>Figure 97. IP3 and Gain Contours for 2140MHz Matching Components</i>
<i>Figure 98. IP3 and Gain Contours for 900MHz Matching Components</i>	<i>Figure 99. IP3 and Gain Contours for 2600MHz Matching Components</i>
<i>Figure 100. IP3 and Gain Contours for 1300MHz Matching Components</i>	<i>Figure 101. IP3 and Gain Contours for 3500MHz Matching Components</i>
<i>Figure 102. IP3 and Gain Contours for 1950MHz Matching Components</i>	

**SOURCE PULL CIRCLES, NOISE FIGURE,  $V_{POS} = 3V$** 

<i>Figure 103. Noise Contours for 500MHz Matching Components</i>	<i>Figure 104. Noise Contours for 2140MHz Matching Components</i>
<i>Figure 105. Noise Contours for 900MHz Matching Components</i>	<i>Figure 106. Noise Contours for 2600MHz Matching Components</i>
<i>Figure 107. Noise Contours for 1300MHz Matching Components</i>	<i>Figure 108. Noise Contours for 3500MHz Matching Components</i>
<i>Figure 109. Noise Contours for 1950MHz Matching Components</i>	



**LOAD PULL CIRCLES, GAIN AND IP3,  $V_{POS} = 3V$**

<i>Figure 110. IP3 and Gain Contours for 500MHz Matching Components</i>	<i>Figure 111. IP3 and Gain Contours for 2140MHz Matching Components</i>
<i>Figure 112. IP3 and Gain Contours for 900MHz Matching Components</i>	<i>Figure 113. IP3 and Gain Contours for 2600MHz Matching Components</i>
<i>Figure 114. IP3 and Gain Contours for 1300MHz Matching Components</i>	<i>Figure 115. IP3 and Gain Contours for 3500MHz Matching Components</i>
<i>Figure 116. IP3 and Gain Contours for 1950MHz Matching Components</i>	

## TUNING THE ADL5521/23 EVAL BOARD FOR OPTIMAL NOISE FIGURE

The ADL5521 and ADL5523 are monolithic LNAs in a 3x3mm LFCSP package. The eval board, as shipped from the factory, should give a noise figure of 0.9dB over a bandwidth of several hundred MHz. The specific frequency where optimal noise is reached depends on the tuning.

The bandwidth of the ADL5521 is 400MHz to 4GHz, although noise figure will degrade above 2.5GHz as the gain begins to roll off.

Note – The factory eval board has a bias resistor on the LNA of 3.3K  $\Omega$ . If this bias resistor is increased to 5.2K  $\Omega$ , the optimal noise figure will drop to 0.8dB, but the tradeoff is that the OIP3 will typically drop from 35 to 33dB. The change in S parameters will be insignificant when changing bias resistors, so this section will only take into account measurements done with 3.3K  $\Omega$  bias resistor.

Contents of this note are based completely on lab measurements. Although there are plots in which the Agilent ADS environment is used, the data in these plots comes completely from lab measurements.

### Tuning S22

Tuning of the LNA begins with S22 (output tuning). Tuning of the LNA output is done by placing reactive components on the bias line, referred to in the schematics in Figure 88 as VPOS.

On the LNA eval board, S22 tuning is achieved by either the use of an inductor (L2) on the bias line, or a shunt cap C3) on the bias line to ground. Typically, either L2 is required, or C3, but not both.

The evaluation board uses a 'slider' on the bias line in order to make tuning for S22 as easy as possible. The slider is an area of ground etch adjacent to the bias line that is clear of solder mask. The bias line in this area is also free of solder mask. This allows a capacitor (C3) to be placed anywhere on the bias line to ground and so provides easy, very accurate tuning for S22.

Note that the PCB layout shows two capacitors, C3 and C4. Typically only one of these is needed for good S22 tuning.

The slider can be seen in the LNA PCB layout in Figure 117 as the red area to the right of the bias line. With a 0  $\Omega$  jumper in place of L2, moving a 1nF capacitor from the top to the bottom effectively tunes S22 from 1400 MHz to 3500MHz. Table 7 shows the component values and placement required for S22 tuning from 800MHz to 3200MHz. For lower frequencies, higher values of L2 can be used to tune S22, and for frequencies from 3.2GHz to 4.0GHz, smaller values of capacitors can be used on the slider.

The results for S22 tuned for different frequencies are shown in Figure 118 to Figure 123.

Frequency (MHz)	L2 (nH)	C3 (nF)	C3 Placement
800	3.4	Open	
1400	0 $\Omega$	Open	
2000	0 $\Omega$	1nF	A
2400	0 $\Omega$	1nF	B
2800	0 $\Omega$	1nf	C
3200	0 $\Omega$	1nf	D

Table 7. Capacitor and Inductor Tuning and Placement for LNA S22 Tuning

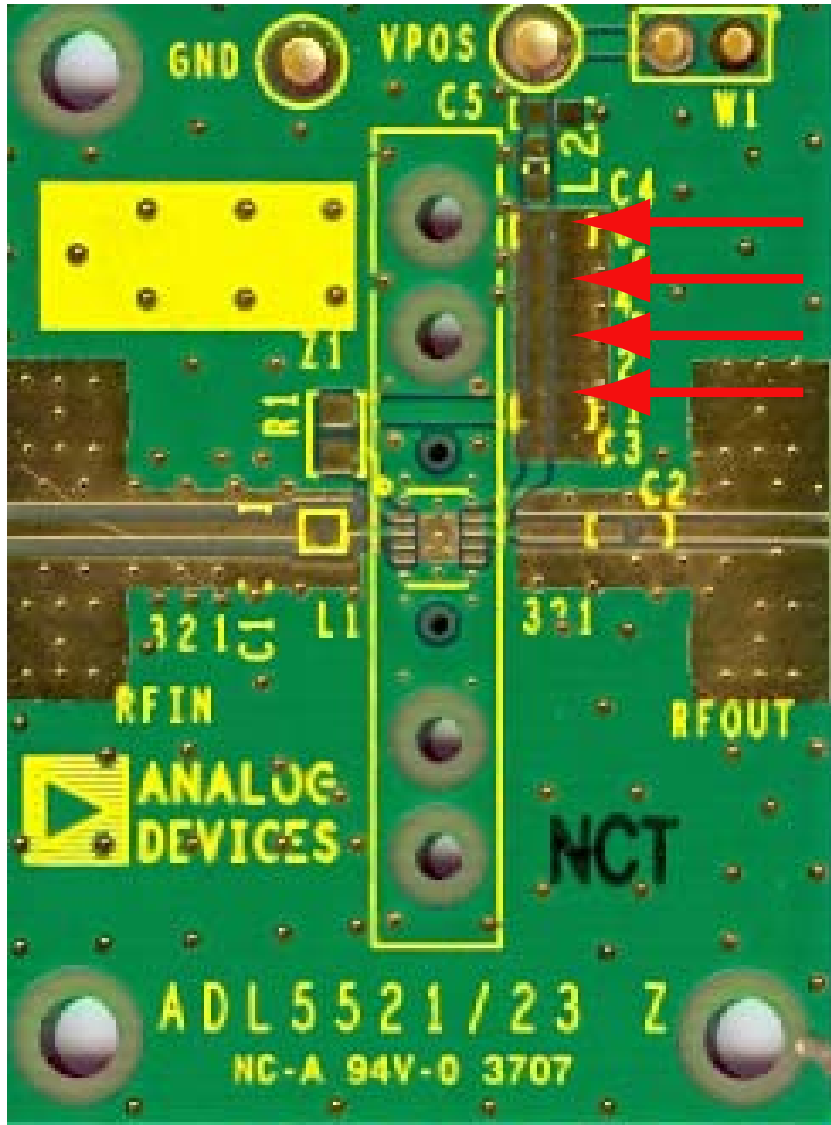

Figure 117. PCB Layout for LNA Eval Board, Note 'Slider' on Bias Line

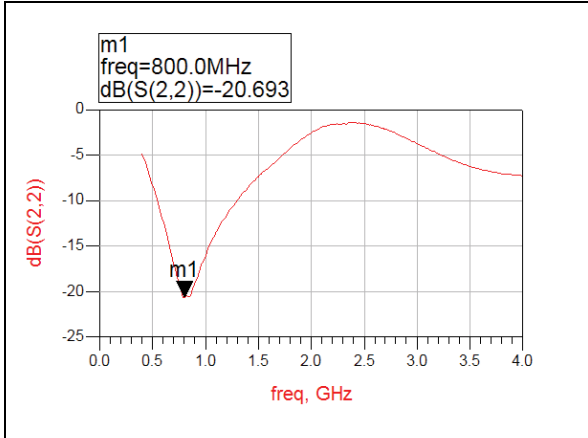

Figure 118. S22 tuned for 800MHz

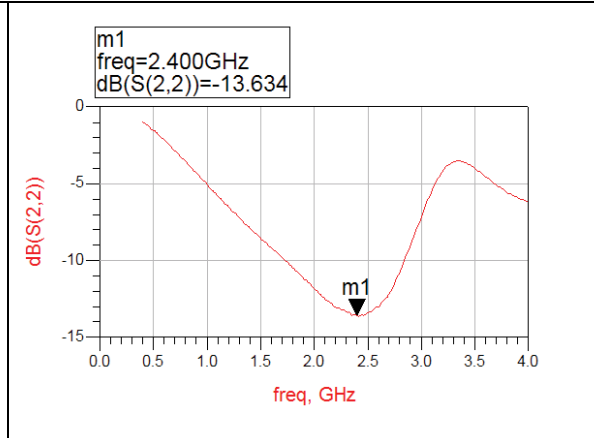

Figure 119. S22 tuned for 2.4GHz

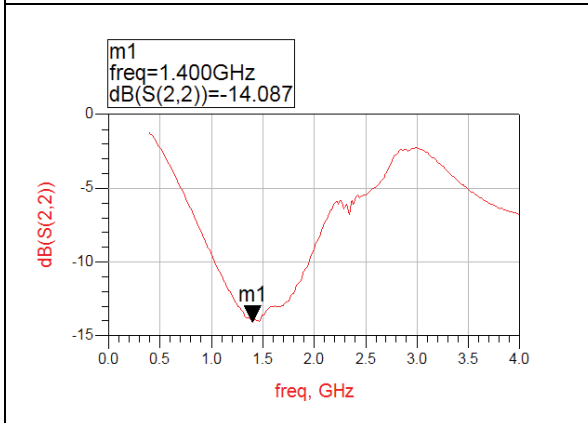

Figure 120. S22 tuned for 1400MHz

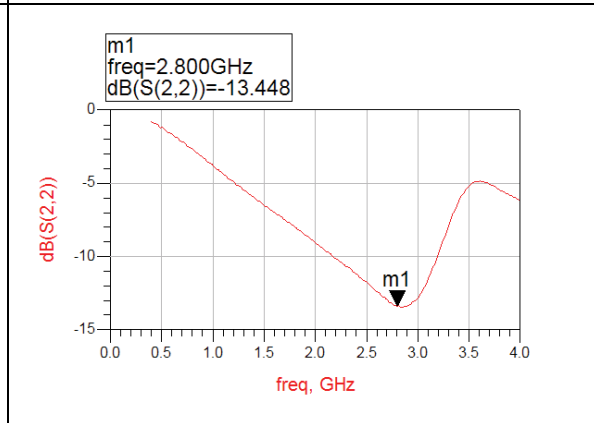

Figure 121. S22 tuned for 2.8GHz

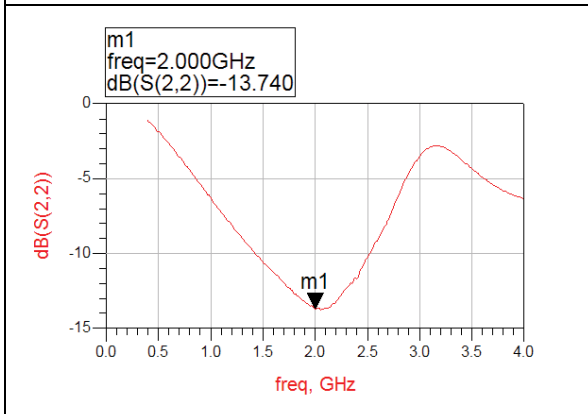

Figure 122. S22 tuned for 2.0GHz

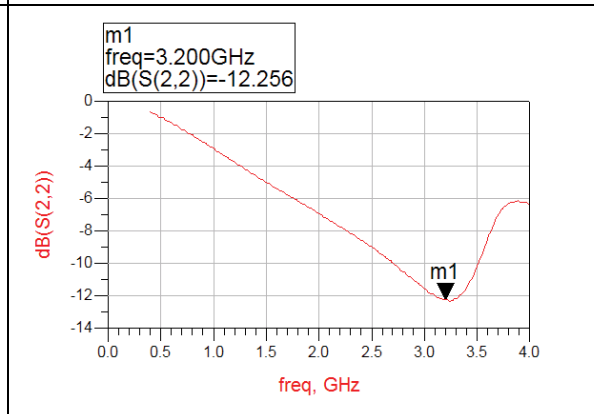

Figure 123. S22 tuned for 3.2GHz

**Tuning the LNA Input for Optimal Gain**

LNAs are generally tuned for either gain or noise optimization, or some tradeoff between the two. One figure of merit of an LNA is how much tradeoff must be made for one of these parameters to optimize the other. With the ADL5521 and ADL5523, S11 of 6 to 8dB at the input to the matching network can still be typically achieved when optimizing for noise.

For optimal gain matching, the goal is to use a matching network that converts the input impedance of the LNA to the characteristic impedance of the system, typically 50 Ω. Correct tuning for gain matching results in a conjugate match. That is, the impedance of the matching network at the LNA input, looking back toward the generator, will always be the complex conjugate of the LNA input impedance when matched for gain.

Once the conjugate of S11 is known, a matching circuit must be found which transforms the 50 Ω system impedance into the conjugate S11 impedance. To do this, the designer starts at the origin of the circle and finds components that move the 50 Ω match to S11\*.

The related impedances for gain matching are shown in Figure 124. A Smith Chart representation of the conjugate match is shown in Figure 125.

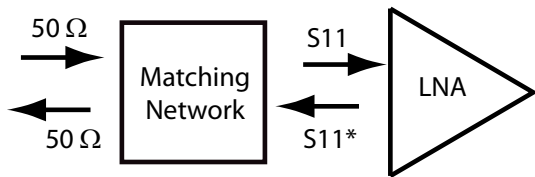

Figure 124. Matching LNA Input for Gain

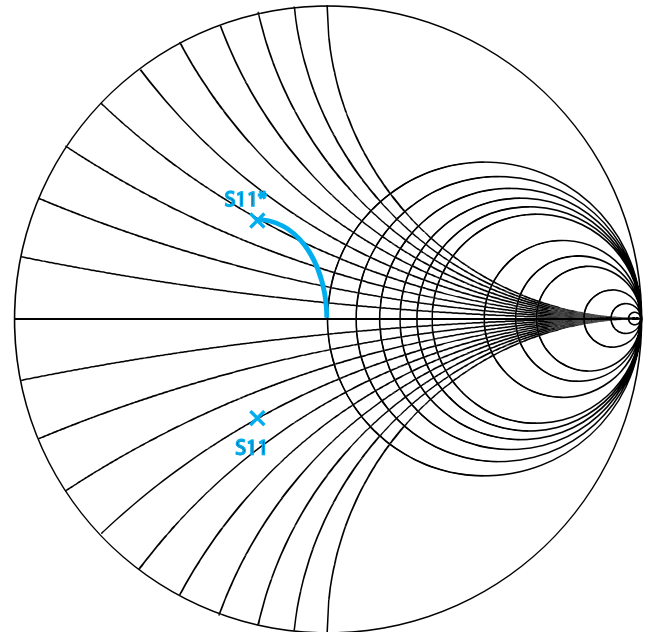

Figure 125. Smith Chart Representation of Conjugate Match

**Tuning the LNA Input for Optimal Noise Figure**

The point in the Smith Chart at which matching for optimal noise occurs is typically referred to as Gamma Optimal, or  $\Gamma_{OPT}$ . It's often different than the gain matching point. Finding  $\Gamma_{OPT}$  is not as obvious as the gain match.  $\Gamma_{OPT}$  is a function of the semiconductor structure and characteristics of the LNA. Typically, the fabrication facility that produces the LNA will have this information.  $\Gamma_{OPT}$  can also be determined by doing source pull testing in the lab.

Noise matching for the ADL5521 and 23 is actually very easy, as the area of the Smith Chart where the noise figure is optimal or near optimal is not confined to a narrow area around  $\Gamma_{OPT}$ . This is very advantageous as it means that component variations will play a smaller part in board to board variation of noise figure.

The matching area for optimal noise for the ADL5523 and ADL5521 is shown in Figure 126. Note that textbooks usually define noise circles as a conjugate match. However, for the purpose of this note this circle is a direct match, we will do things slightly differently. In our case to find the correct matching circuit, the designer must start with the S11 of the LNA, then select components which move the S11 to within this circle.

One important aspect of the overall ADL5521 and 23 ease of tuning is that as long as S22 is matched for a particular frequency, this noise matching area remains very consistent in its placement for that frequency. Said another way, if S22 is matched, we simply have to take the measured S11 and move it into the black circle for optimal noise matching.

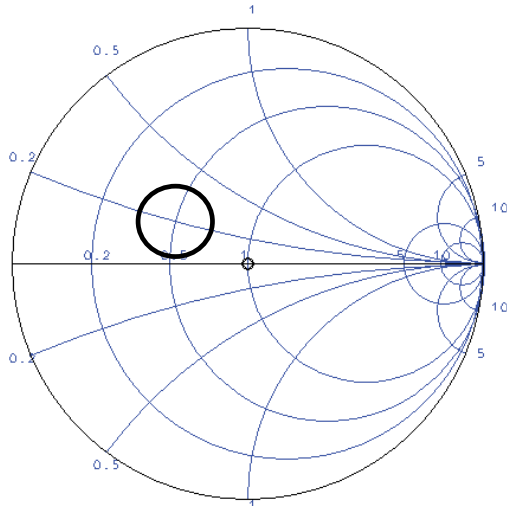

Figure 126. Area of Optimal Noise Matching for ADL5521, 23

**S11 Parameters of ADL5521,23 with S22 Matched**

To determine the correct matching circuit for optimal noise, the next step is to look at the results of S11 for the various frequencies at which S22 was tuned earlier in this note. Once the S11 is determined for a particular frequency, all that needs to be done is to find the matching components that provide that match.

Figure 127 to Figure 132 show S11 for the various frequencies. Again, these measurements are all based on S22 being matched at that particular frequency.

Note that the S11 for every example shown in Figure 127 to Figure 132 is either in the lower left quadrant of the Smith Chart or slightly into the upper left. To move this impedance in the given noise circle first requires a series L component at the LNA input. The values for L in all of the examples will differ, but a correct value of L will move the match along the constant R circle up into upper left quadrant of the Smith Chart.

A shunt capacitor can then be added to move the match along a constant admittance line, down and to the right, hopefully right into the center of the noise circle given in Figure 126.

The solution for the structure of the match for all of the examples in Figure 127 to Figure 132 is a series L to the input of the LNA, and a shunt capacitor at the generator end of this inductor.

An example of the effect of the series L, shunt C match, based on the 800MHz example, is given in Figure 133. This example uses the output from the Agilent ADS Smith Chart tool.

Frequency	C1	C2	C3	C5	L1	L2
500MHz	na	82pf	na	1nf	9nH	12nH
750MHz	2.0pf				11nH	3.4nH
900 MHz	2.4pF				8.2nH	3.4nH
1400 MHz	2.4pF				5.1nH	0 Ω
1950 MHz	1.3pF	1nF	1nF	1nF	1.1nH	0 Ω
2150 MHz	1.3pf				1.1nH	0 Ω
2400 MHz	1.3pf				1.3nH	0 Ω

Table 8. L and C Values for ADL5521 Matching Circuits at Various Frequencies

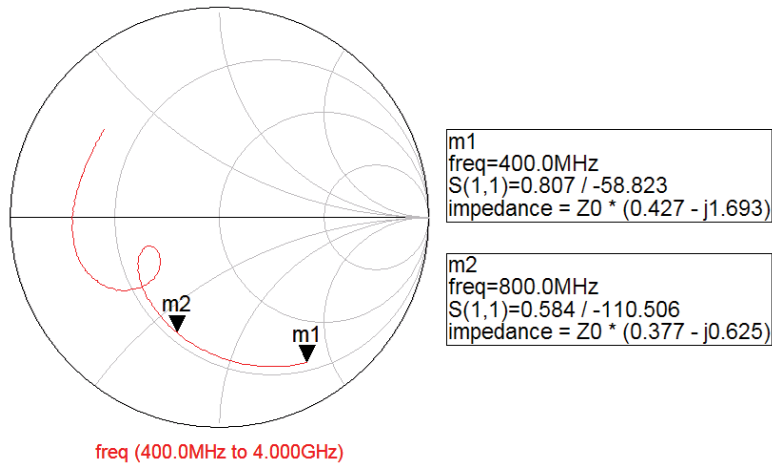

Figure 127. S11 of ADL5521 with S22 Matched at 800MHz

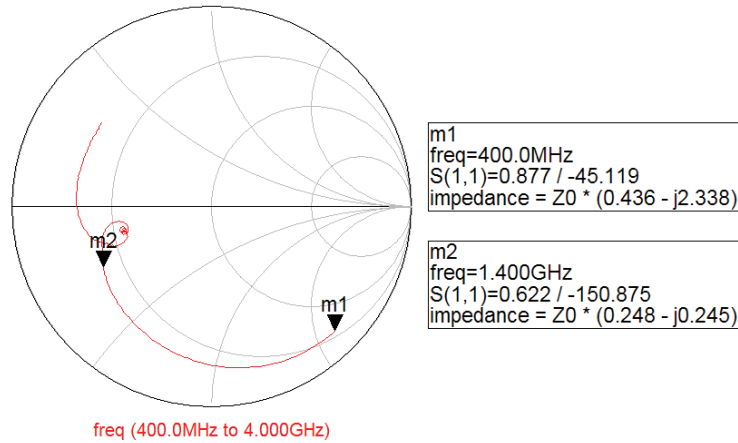

Figure 128. S11 of ADL5521 with S22 Matched at 1.4 GHz

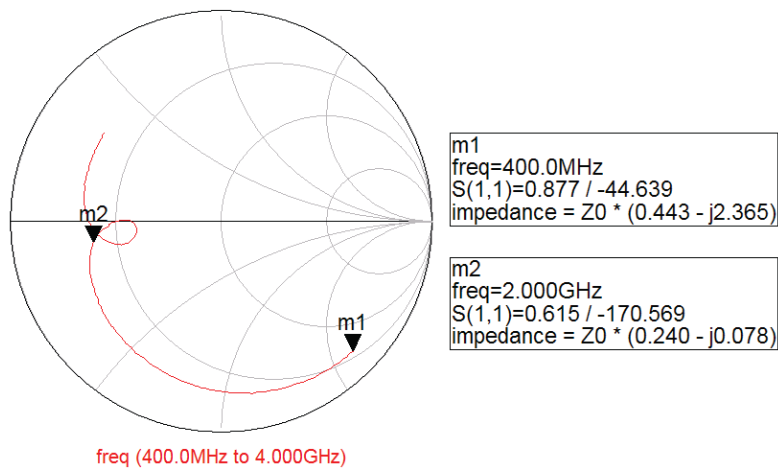

Figure 129. S11 of ADL5521 with S22 Matched at 2.0 GHz

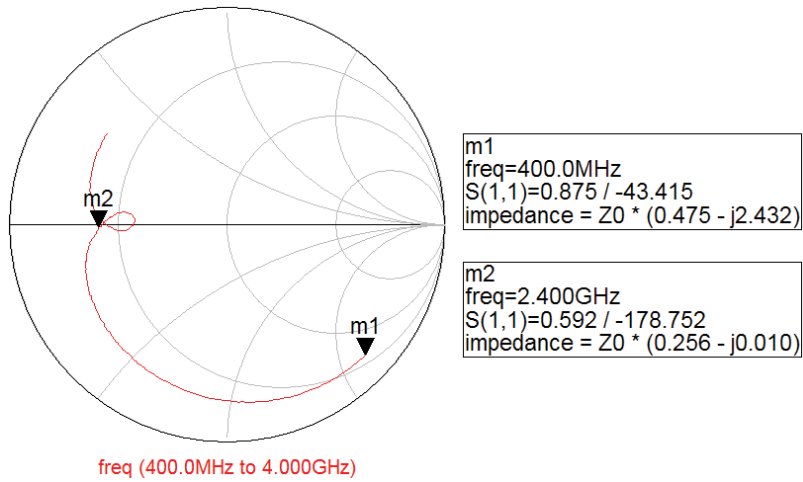

Figure 130. S11 of ADL5521 with S22 Matched at 2.4 GHz

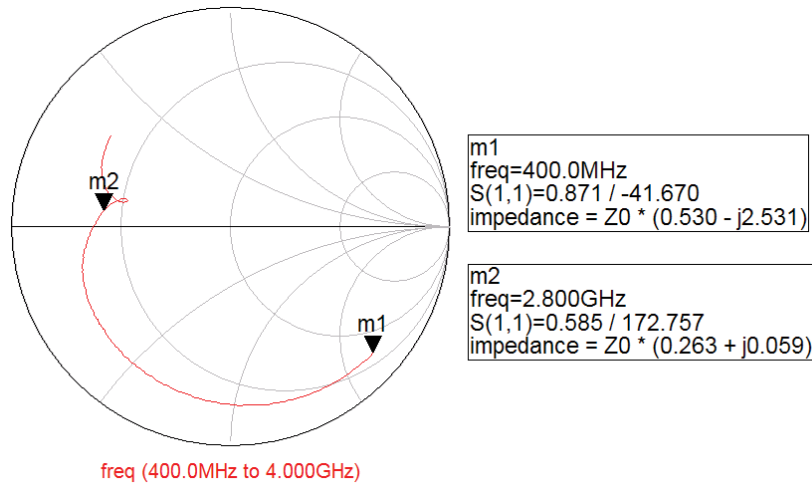

Figure 131. S11 of ADL5521 with S22 Matched at 2.8 GHz

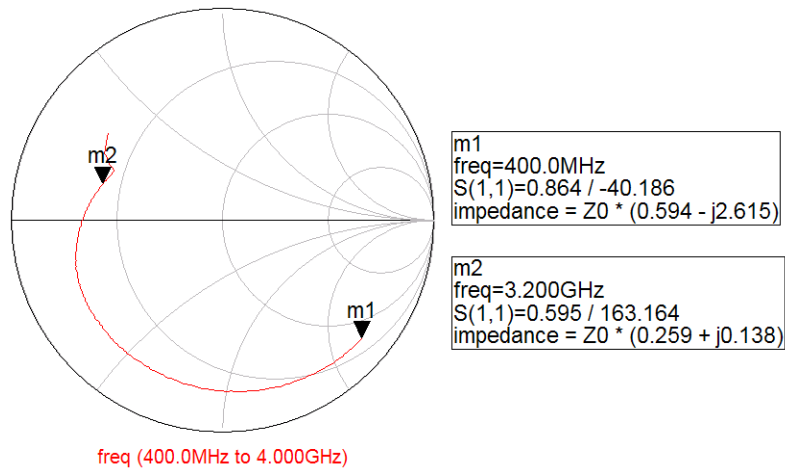

Figure 132. S11 of ADL5521 with S22 Matched at 3.2 GHz



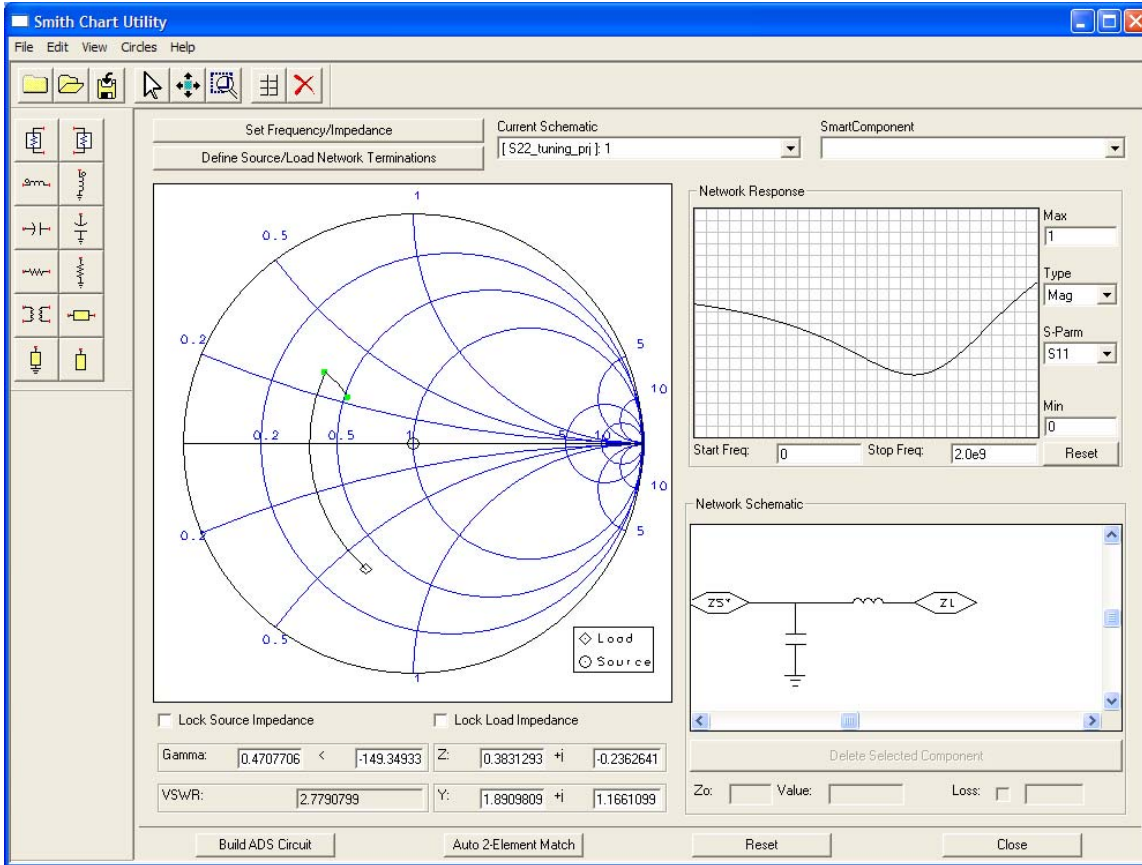

Figure 133. Example of Series L, Shunt C Matching Network for  $\Gamma_{OPT}$  (800MHz Example)

**Example of Optimal Noise Matching at 850MHz**

Based on the S11 information given in Figure 127, a value of L of 9.0nH and a value of C of 2.2pf were experimentally determined in the lab. The measured results of Noise Figure and S parameters are given in Figure 134, Figure 135, and Figure 136

**Example of Optimal Noise Matching at 2.4GHz**

Based on the S11 information given in Figure 1275, a value of L of 1.3nH and a value of C of 1.3pf were experimentally determined in the lab. The measured results of Noise Figure and S parameters are given in Figure 137, Figure 138, and Figure 139.

Optimal matching component values for several other frequencies are given in Table 8.

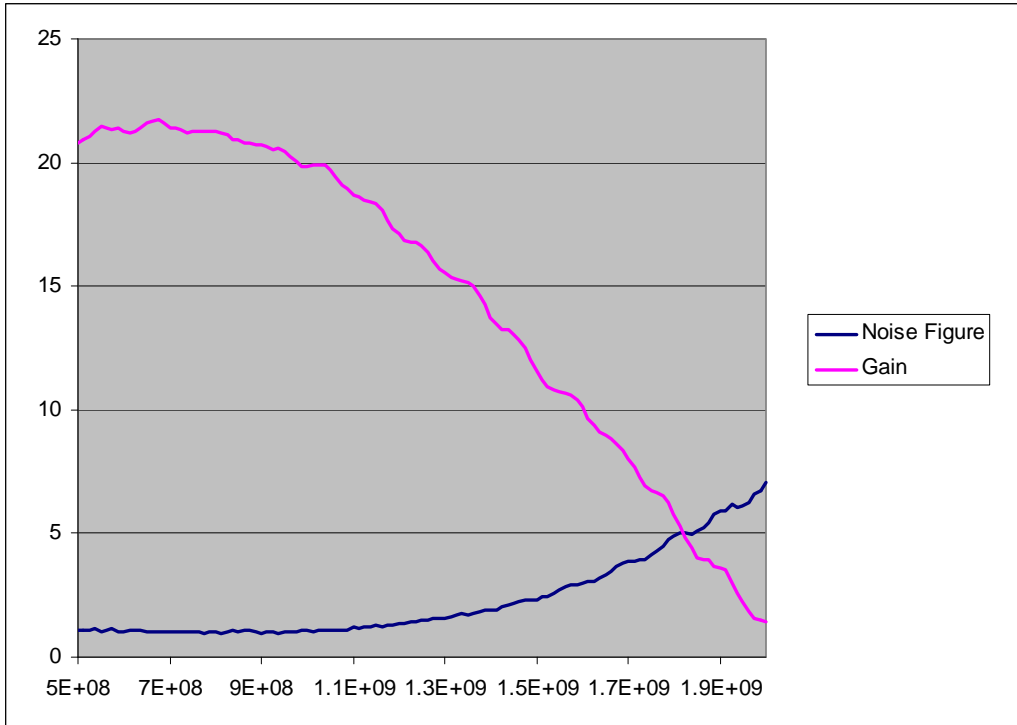

Figure 134. Noise Figure of ADL5521 When Tuned for 850MHz

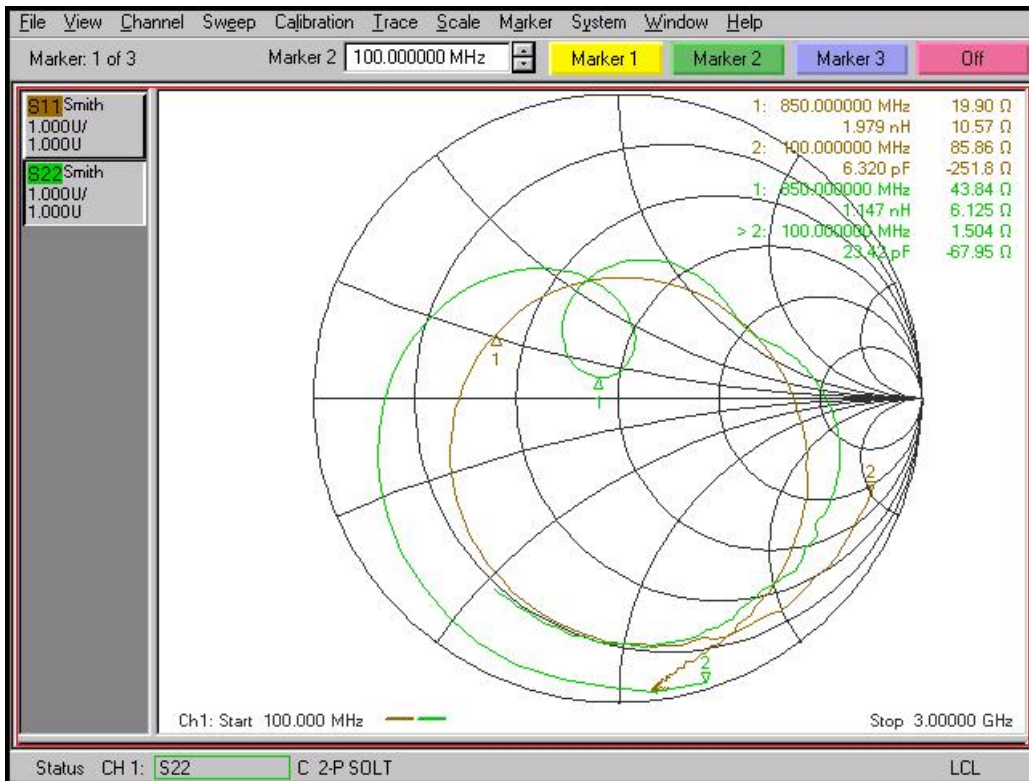

Figure 135. S22 and S11 Matching for ADL5521, 850MHz Example

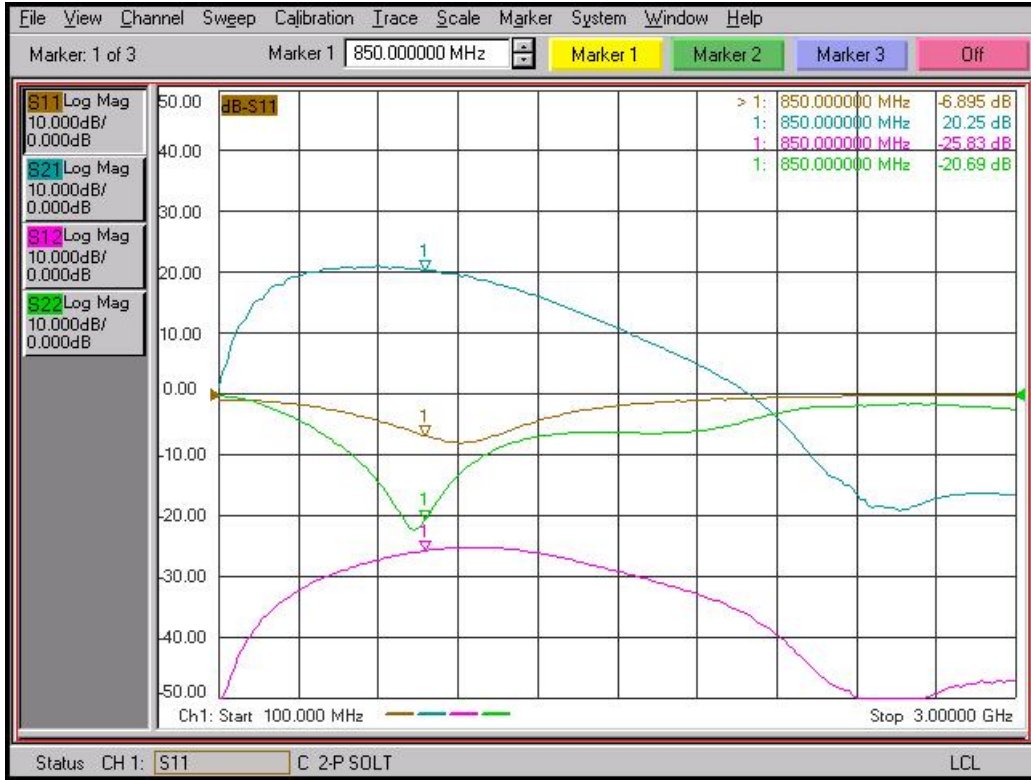

Figure 136. Log-Log Plot of S Parameters, ADL5521 850MHz Example

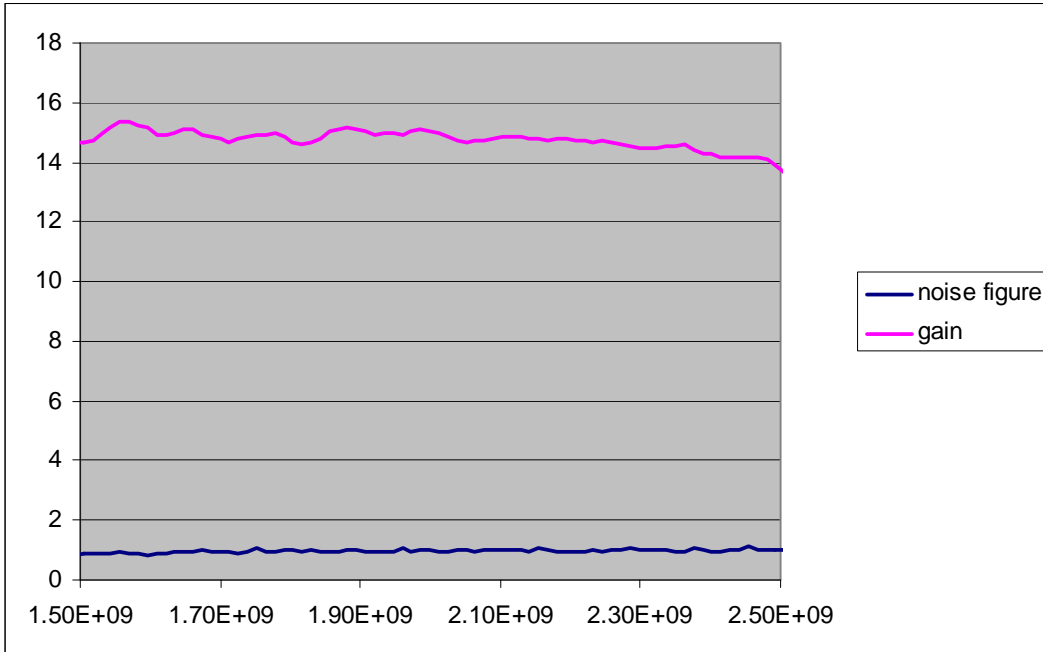

Figure 137. Noise Figure of ADL5521 When Tuned for 2.4GHz

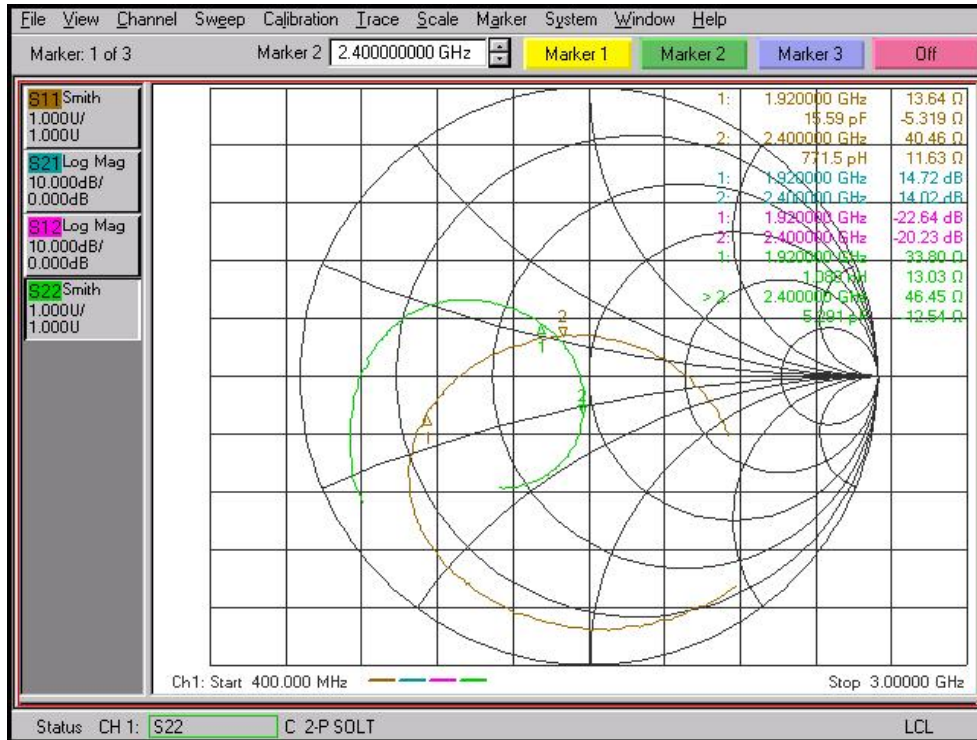

Figure 138. S22 and S11 Matching for ADL5521, 2.4GHz Example



Figure 139. Log-Log Plot of S Parameters, ADL5521 2.4GHz Example

**OUTLINE DIMENSIONS**

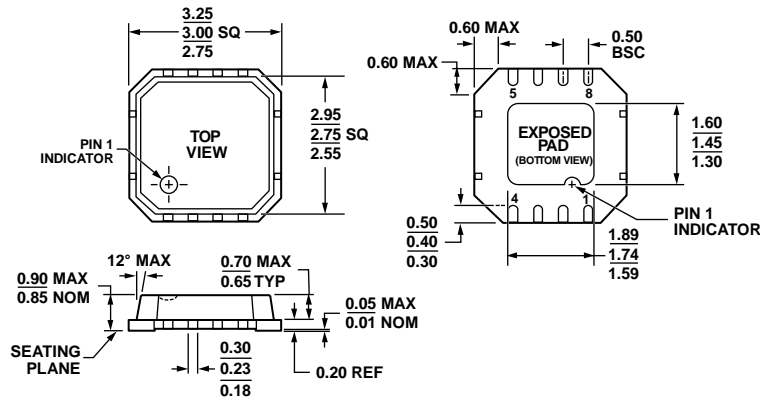

Figure 140. 8-Lead Lead Frame Chip Scale Package [LFCSP\_VD]  
 3mm x 3 mm Body, Very Thin, Dual Lead CP-8-2  
 Dimensions shown in millimeters

**ORDERING GUIDE**

Model	Temperature Range	Package Description	Package Option
ADL5521ACPZ-R7 <sup>1</sup>	-40°C to +85°C	7" Tape and Reel	CP-8-2
ADL5521ACPZ-WP <sup>1</sup>	-40°C to +85°C	Waffle Pack	CP-8-2
ADL5521-EVALZ		Evaluation Board	

ADL5521 is qualified to the reflow profile in JEDEC standard J-STD-020 at a peak temp of 260C. Moisture sensitivity level per JEDEC standard J-STD-20 is MSL3.

<sup>1</sup> Z = Pb free part