

HFA16PA60CPbF

Ultrafast, Soft Recovery Diode

Features

- Ultrafast Recovery
- Ultrasoft Recovery
- Very Low I_{RRM}
- Very Low Q_{rr}
- Specified at Operating Conditions
- Lead-Free

Benefits

- Reduced RFI and EMI
- Reduced Power Loss in Diode and Switching Transistor
- Higher Frequency Operation
- Reduced Snubbing
- Reduced Parts Count

Description

International Rectifier's HFA16PA60C is a state of the art center tap ultra fast recovery diode. Employing the latest in epitaxial construction and advanced processing techniques it features a superb combination of characteristics which result in performance which is unsurpassed by any rectifier previously available. With basic ratings of 600 volts and 8 amps per Leg continuous current, the HFA16PA60C is especially well suited for use as the companion diode for IGBTs and MOSFETs. In addition to ultra fast recovery time, the HEXFRED product line features extremely low values of peak recovery current (I_{RRM}) and does not exhibit any tendency to "snap-off" during the t_b portion of recovery. The HEXFRED features combine to offer designers a rectifier with lower noise and significantly lower switching losses in both the diode and the switching transistor. These HEXFRED advantages can help to significantly reduce snubbing, component count and heatsink sizes. The HEXFRED HFA16PA60C is ideally suited for applications in power supplies and power conversion systems (such as inverters), motor drives, and many other similar applications where high speed, high efficiency is needed.

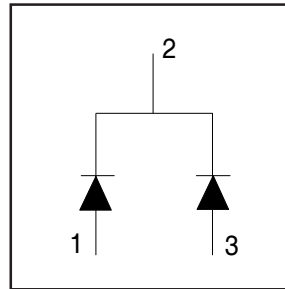

$V_R = 600V$
$V_F = 1.7V$
$Q_{rr}^* = 65nC$
$di_{(rec)M}/dt^* = 240A/\mu s$
* 125°C

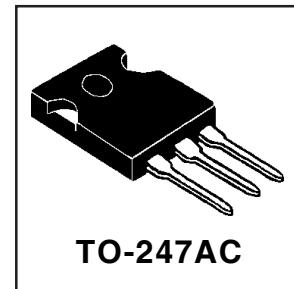

Absolute Maximum Ratings (per Leg)

	Parameter	Max	Units
V_R	Cathode-to-Anode Voltage	600	V
$I_F @ T_C = 100^\circ C$	Continuous Forward Current (per Leg)	8	A
I_{FSM}	Single Pulse Forward Current	60	
I_{FRM}	Maximum Repetitive Forward Current	24	
$P_D @ T_C = 25^\circ C$	Maximum Power Dissipation	36	W
$P_D @ T_C = 100^\circ C$	Maximum Power Dissipation	14	
T_J	Operating Junction and	-55 to +150	°C
T_{STG}	Storage Temperature Range		

Electrical Characteristics (per Leg) @ T_J = 25°C (unless otherwise specified)

	Parameter	Min.	Typ.	Max.	Units	Test Conditions
V _{BR}	Cathode Anode Breakdown Voltage	600			V	I _R = 100μA
V _{FM}	Max Forward Voltage		1.4	1.7	V	I _F = 8A
			1.7	2.1		I _F = 16A
			1.4	1.7		I _F = 8A, T _J = 125°C
I _{RM}	Max Reverse Leakage Current		0.3	5	μA	V _R = V _R Rated
			100	500		T _J = 125°C, V _R = 0.8 x V _R Rated
C _T	Junction Capacitance		10	25	pF	V _R = 200V
L _S	Series Inductance		8.0		nH	Measured lead to lead 5mm from package body

Dynamic Recovery Characteristics (per Leg) @ T_J = 25°C (unless otherwise specified)

	Parameter	Min	Typ	Max	Units	Test Conditions
t _{rr}	Reverse Recovery Time		18		ns	I _F = 1.0A, di _F /dt = 200A/μs, V _R = 30V
t _{rr1}	See Fig. 5, 6 & 16		37	55		T _J = 25°C
t _{rr2}			55	90		T _J = 125°C
I _{RRM1}	Peak Recovery Current See Fig. 7 & 8		3.5	5.0	A	T _J = 25°C
			4.5	8.0		T _J = 125°C
Q _{rr1}	Reverse Recovery Charge See Fig. 9 & 10		65	138	nC	T _J = 25°C
Q _{rr2}			124	360		T _J = 125°C
di _{(rec)M} /dt1	Peak Rate of Fall of Recovery Current During t _b See Fig. 11 & 12		240		A/μs	T _J = 25°C
di _{(rec)M} /dt2			210			T _J = 125°C

Thermal - Mechanical Characteristics

	Parameter	Min	Typ	Max	Units
T _{lead} ^①	Lead Temperature			300	°C
R _{thJC}	Junction-to-Case, Single Leg Conducting			3.5	K/W
	Junction-to-Case, Both Legs Conducting			1.75	
R _{thJA} ^②	Thermal Resistance, Junction to Ambient			40	
R _{thCS} ^③	Thermal Resistance, Case to Heat Sink		0.25		
Wt	Weight		6		g
			0.21		(oz)
	Mounting Torque	6		12	Kg-cm
		5		10	lbf·in

① 0.063 in. from Case (1.6mm) for 10 sec

② Typical Socket Mount

③ Mounting Surface, Flat, Smooth and Greased

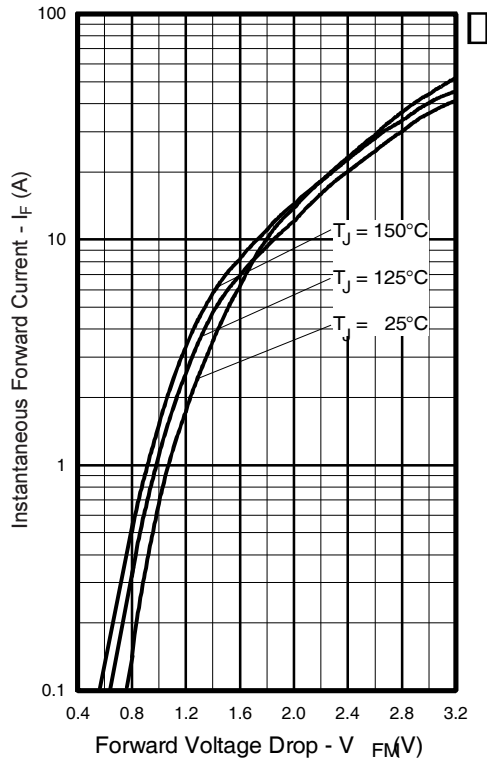

Fig. 1 - Maximum Forward Voltage Drop vs. Instantaneous Forward Current, (per Leg)

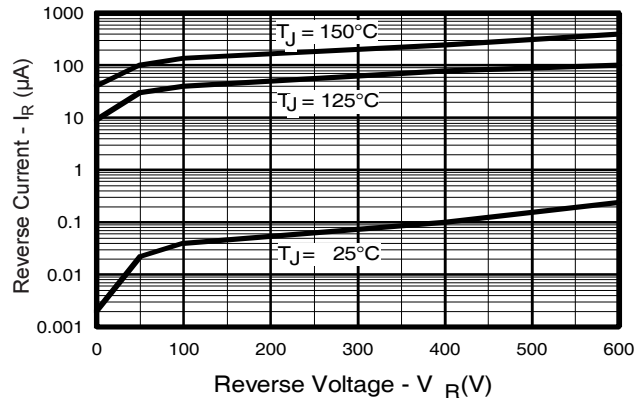

Fig. 2 - Typical Reverse Current vs. Reverse Voltage, (per Leg)

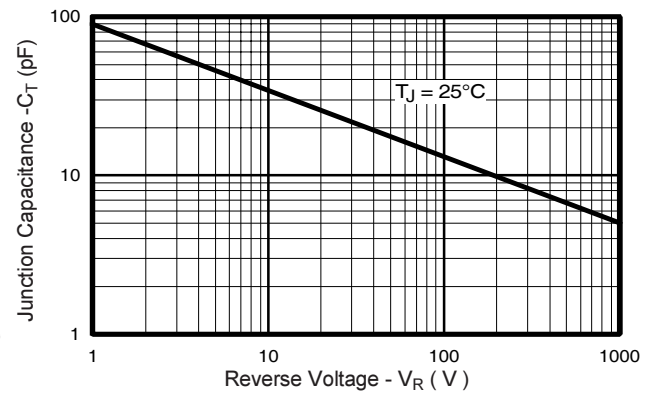

Fig. 3 - Typical Junction Capacitance vs. Reverse Voltage, (per Leg)

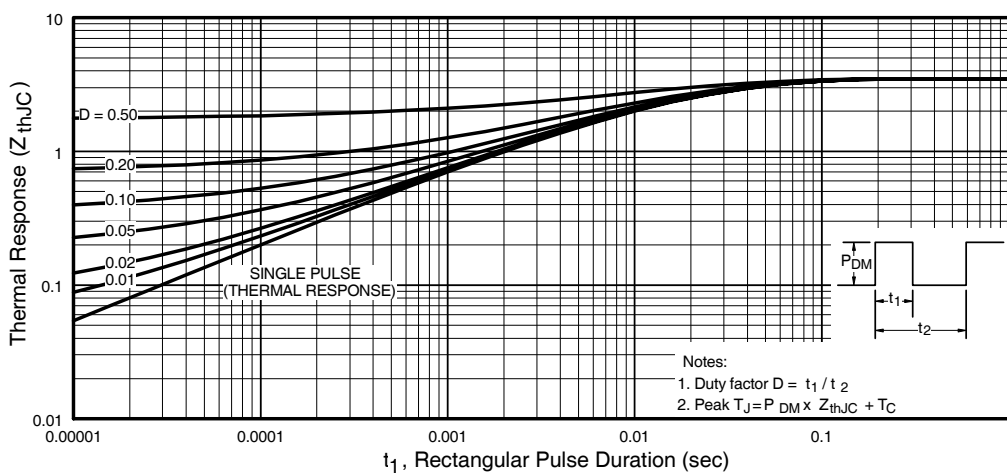

Fig. 4 - Maximum Thermal Impedance Z_{thJC} Characteristics, (per Leg)

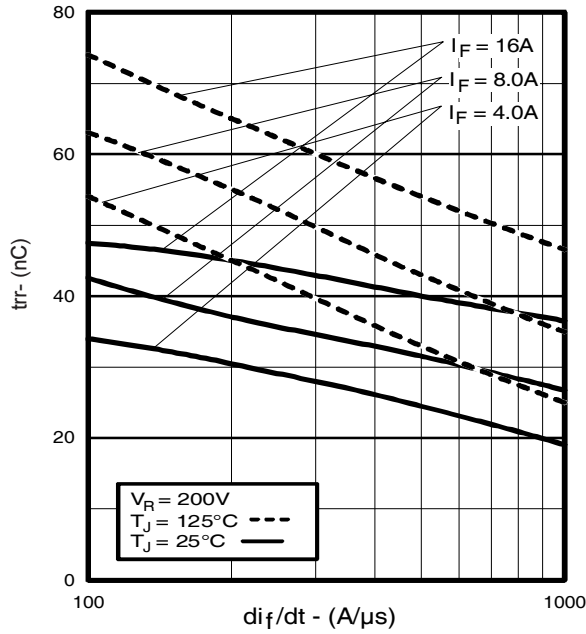

Fig. 5 - Typical Reverse Recovery vs. di_f/dt ,
 (per Leg)

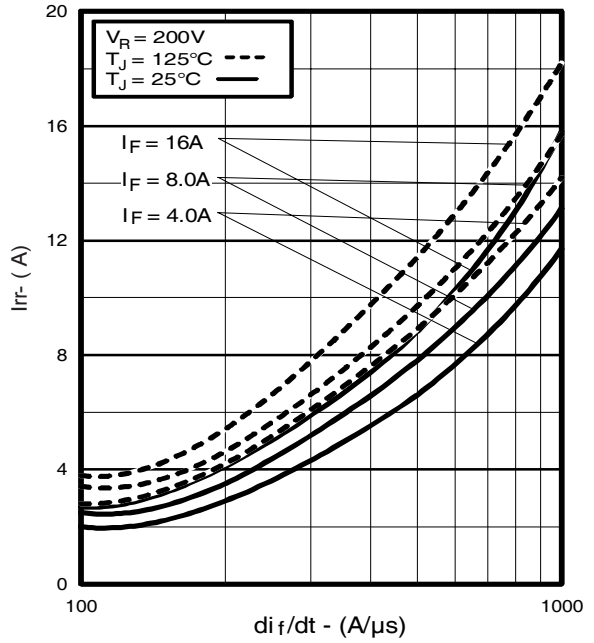

Fig. 6 - Typical Recovery Current vs. di_f/dt ,
 (per Leg)

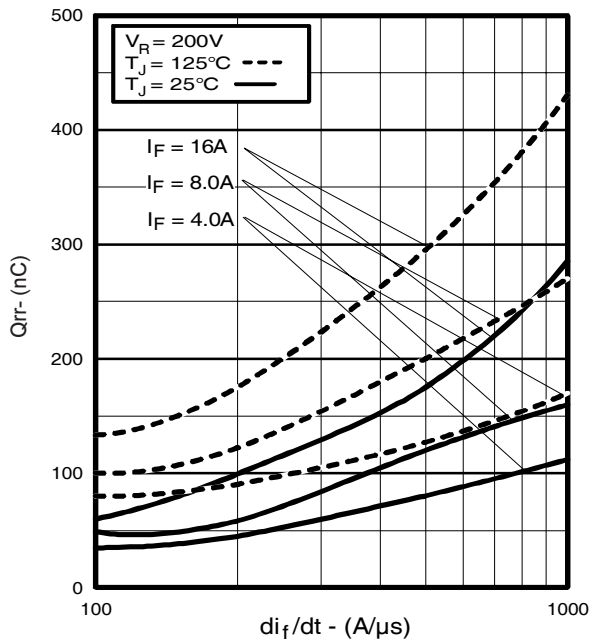

Fig. 7 - Typical Stored Charge vs. di_f/dt ,
 (per Leg)

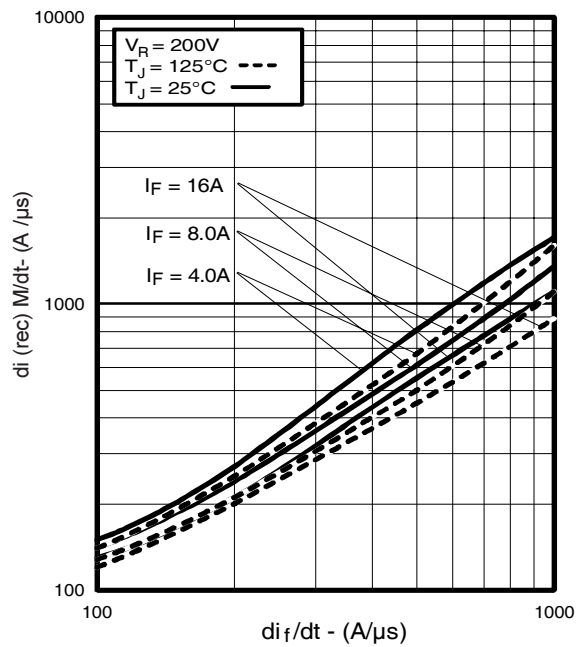

Fig. 8 - Typical $di_{(rec)}M/dt$ vs. di_f/dt ,
 (per Leg)

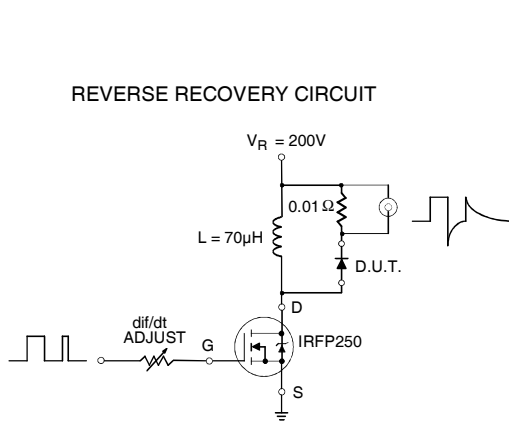

Fig. 9 - Reverse Recovery Parameter Test Circuit

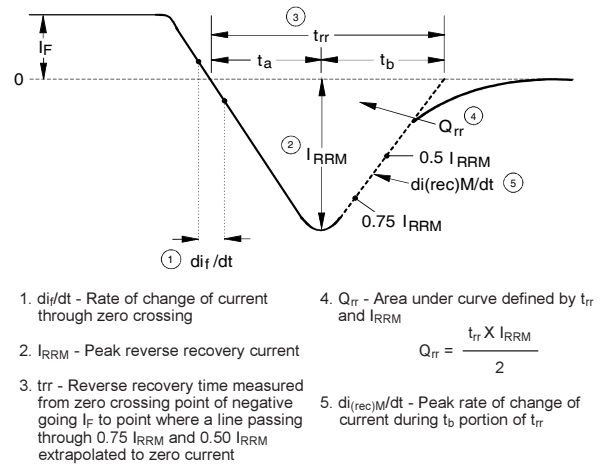

Fig. 10 - Reverse Recovery Waveform and Definitions

Ordering Information Table

Device Code					
HF	A	16	PA	60	C
①	②	③	④	⑤	⑥
1	- Hexfred Family				
2	- Process Designator		A = subs. elec. Irrad. B = subs. Platinum		
3	- Current Rating		(16 = 16A)		
4	- Package Outline		(PA = TO-247, 3 pins)		
5	- Voltage Rating		(60 = 600V)		
6	- Configuration		(C = Center Tap Common Cathode)		
Note: "PbF" suffix at the end of the part number indicates Lead-Free.					

HFA16PA60CPbF



TO-247AC Package Outline

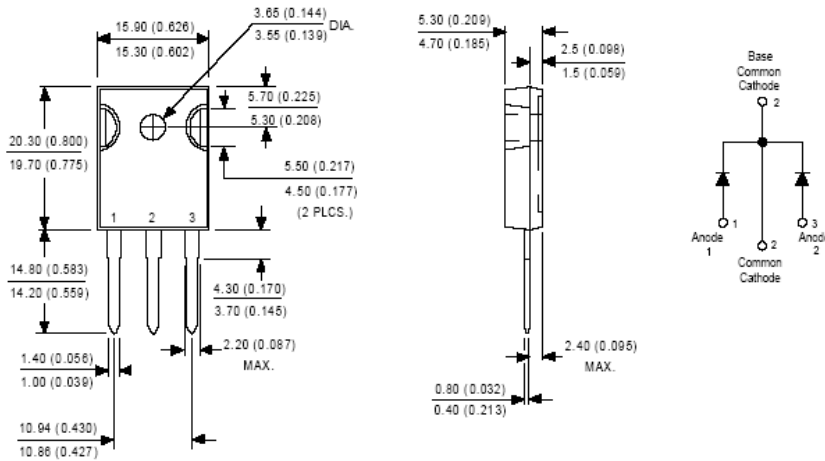

Conform to JEDEC outline TO-247AC (TO-3P)
Dimensions in millimeters and (inches)

TO-247AC Part Marking Information

EXAMPLE: THIS IS A HFA16PA60C
WITH ASSEMBLY
LOT CODE 5657
ASSEMBLED ON WW 35, 2000
IN ASSEMBLY LINE "H"

Note: "P" in the beginning of date code
indicates "Lead-Free"

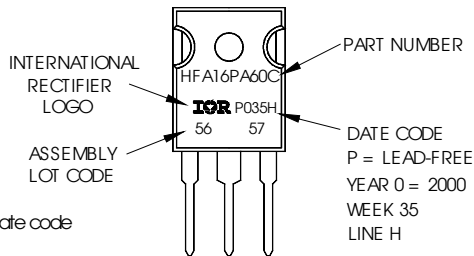

Data and specifications subject to change without notice.
This product has been designed and qualified for Industrial Level.
Qualification Standards can be found on IR's Web site.



IR WORLD HEADQUARTERS: 233 Kansas St., El Segundo, California 90245, USA Tel: (310) 252-7105
TAC Fax: (310) 252-7903
Visit us at www.irf.com for sales contact information.10/04