

# 13.56MHz RFID Transponder

## Features

- Very low operating current (15 $\mu$ A at V<sub>DD</sub>=2V)
- Wide range operating voltage
- Batteryless RF transponder
- Data transmission in read-only operation
- Max. of 6 bits customer programmable data
- 6 bits checksum for error rejection
- OTP data memory
- 13.56MHz carrier frequency
- Output data baud rate: 10kbps (Typ.) at V<sub>DD</sub>=3V
- PWM/ASK modulation
- Built-in voltage limiter
- Non anti-collision function (Default)
- 8-pin DIP package available for engineering evaluation - not for volume production

## Applications

- Interactive leisure products
- Security system
- Access control
- Anti-counterfeit devices
- Material management
- Animal management
- Personnel working time record
- Car park monitoring system

## General Description

The HT6740 is an RF transponder IC with 13.56MHz RF carrier, which provides a low cost batteryless transponder solution when combined with an external inductor. The inductor and internal capacitor form an LC tank which induce voltage from the radiated 13.56MHz carrier signal generated from the reader antenna. HT6740 has a built-in low power RC oscillator which is activated if the induced carrier field strength is high enough to supply the operating current and the response signal (pre-programmed in the OTP memory) is serially transmitted out. The response data is transmitted using PWM/ASK modulation. Modulation of 13.56MHz is accomplished by damping the LC tank with a fixed baud rate.

The transmission information is stored in a 17 bits one time programmable memory OTP, with a 6-bit checksum (up to 11 bits reserved for customer). The effective

detection range for a small sized antenna is 2cm~10cm which is dependent on antenna format & reader design. The larger the antenna loop used the longer the detection range. It is advisable to use larger antenna to attain a 15 cm detection range.

Implementing Holtek's advanced OTP and low power technology, HT6740 offers a very cost effective solution for RF contactless detection system.

A code area of 11 bits (max.) wide is provided so customers can program the device using the specified programmer supplied by Holtek. The pre-programmed ICs are also available upon customer's request.

The HT6740 has a built-in anti-collision function. Customers can choose with anti-collision or with non anti-collision function in the program software tool supplied by Holtek.

## Block Diagram

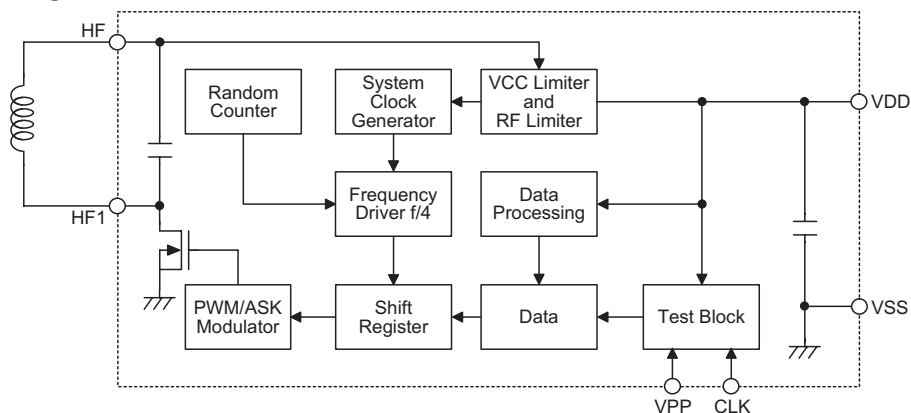

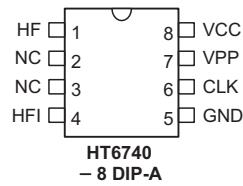
**Pad Assignment**

Note: The 8-pin DIP package type is supplied only for engineering evaluation purposes and will not be available in production volumes.

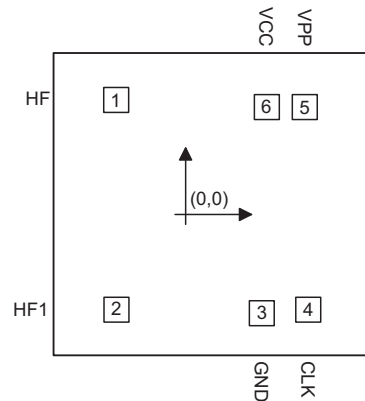
**Pad Assignment**

Chip size: 965×914 (μm)<sup>2</sup>

\* The IC substrate should be connected to VSS in the PCB layout artwork.

**Pad Coordinates**

Unit: μm

Pad No.	X	Y	Pad No.	X	Y
1	-272.025	303.662	4	266.324	-297.913
2	-272.025	-298.538	5	257.400	312.150
3	132.225	-314.688	6	145.924	312.112

**Pad Description**

Pad No.	Pad Name	I/O	Internal Connection	Description
1	HF	I/O	CMOS	Connect to an antenna coil for normal operation. Open for data programming.
2	HF1	I/O	CMOS	Connect to an antenna coil for normal operation. Data I/O for programming.
3	VSS	—	—	Negative power supply, ground
4	CLK	I	CMOS	Open for normal operation. Clock input for programming.
5	VPP	I	—	Open for normal operation. High voltage supplies input for programming. (Suggest 12.5V for programming)
6	VDD	—	—	Open for normal operation, +6V supply input for programming.

**Absolute Maximum Ratings**

Supply Voltage (VDD) .....	6V	Storage Temperature .....	-50°C to 125°C
Supply Voltage (VPA) .....	12.5V	Operating Temperature .....	0°C to 70°C
Input Voltage .....	V <sub>SS</sub> -0.3V to V <sub>DD</sub> +0.3V		

Note: These are stress ratings only. Stresses exceeding the range specified under "Absolute Maximum Ratings" may cause substantial damage to the device. Functional operation of this device at other conditions beyond those listed in the specification is not implied and prolonged exposure to extreme conditions may affect device reliability.

**Electrical Characteristics**

Symbol	Parameter	Test Conditions		Min.	Typ.	Max.	Unit
		V <sub>DD</sub>	Conditions				
V <sub>DD</sub>	Operating Voltage	—	V <sub>DD</sub> pad voltage	2.0	3	4	V
I <sub>dd</sub>	Operating Current	2V	—	—	15	—	μA
		3V	—	—	400	—	μA
R <sub>m</sub>	Modulation Resistance	3.3V	—	—	320	—	Ω
V <sub>LCL</sub>	LC Input Limiter Voltage	—	—	—	6.5	—	V
B <sub>R</sub>	Output Data Baud Rate	3V	V <sub>DD</sub> vs V <sub>SS</sub>	5	10	15	Kbps

**Functional Description**
**Operation Concept**

The reader transmits a 13.56MHz carrier signal from its antenna, the LC tank on the transponder side converts the carrier energy to voltage form and supply to the transponder chip with an internal pump circuit. If the induced energy is high enough, the pumped voltage reaches the break-in voltage of the internal RC-oscillator, the transponder is actuated to transmit its internal data serially by means of damping the LC tank.

The reader receives the transponder's data by means of detecting the energy variation on its own antenna, and recognize the information with a microcontroller.

The HT6740 has a built-in internal Voltage Limiter to prevent excess power supply and RF levels induced by the LC tank from damaging the device or causing the device to function abnormally.

A total of 23 bits of OTP memory space is provided, from which 6 bits wide are customer programmable, which can be programmed using the specified programmer supplied by Holtek. The pre-programmed ICs are also available upon customer's request.

**Anti-Collision Function**

HT6740 build in anti-collision function. The probability which reader could "find" all (ex.5 tags): Under 10K baud rate. During 103ms→0.8293; During 308ms→0.9950; During 408ms→0.9992 and during 510ms is 0.99995.

**Option Function**

Option 0: 0 continuous (Default)  
1 anti-collision

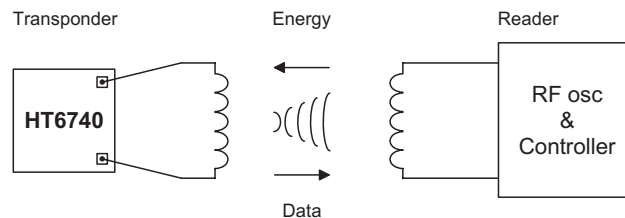
**Timing & Code Package**

**Code Package**

A total of 23 bits information can be stored in the HT6740, from which 6 bits are customer programmable.

- Sync. data: Including 4 bits (which low/high duty length is 50%)
- Mark data: 2 bits (always high signal).

- Customer ID: This 5-bit wide code is not customer programmable and is supplied together with the data writer after register to Holtek. The writer generates the code automatically.
- Product code: Storing the contents of the user ID number or data.
- Check sum: A 6 bits of checksum code is generated automatically by the writer.

**Application Circuits**

**Tag**

A tag consists of a PCB (or Mylar film) with printed coil, HT6740 and a housing. The housing can be of various shapes.

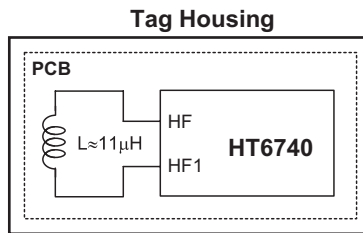

Note: The value of the antenna inductance is 11 μH, however the optimum value will be changed slightly due to the variation of the internal resonance capacitor (10pF typically) during process.

For more application information about the reader, refer to Holtek's 13.56MHz RF ID reader data.

**2-Chip Solution**

**Holtek Transponder Solution**

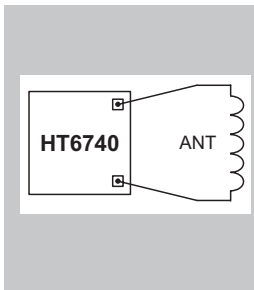

Energy  
Data

**Holtek Reader Solution**

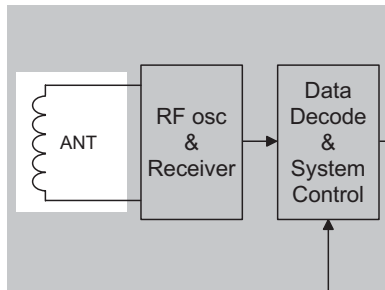

**Other Controller**

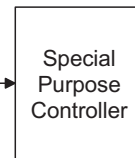

Holtek low cost MCU:  
HT48R05A-1/HT48R06A-1

**1-Chip Solution (I)**

**Holtek Transponder Solution**

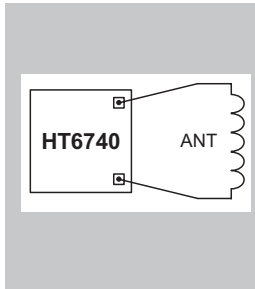

**Holtek Reader Solution**

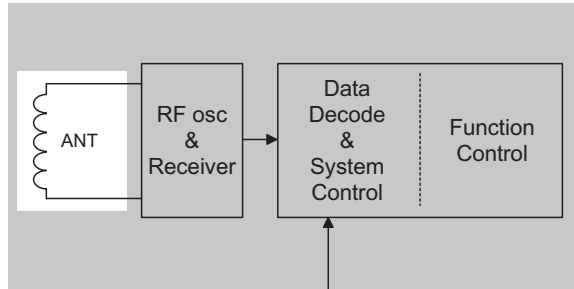

Holtek Standard MCU:  
HT48XXX/HT49XXX

**1-Chip Solution (II)**

**Holtek Transponder Solution**

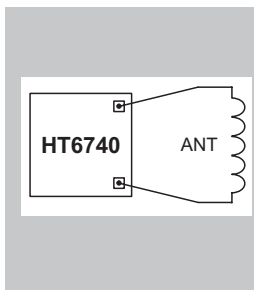

**Holtek Reader Solution**

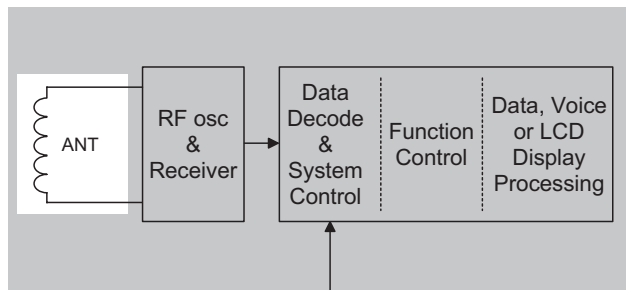

Holtek Embedded MCU:  
HTG21XX/HT86XXX

RFID Reader Application Circuit

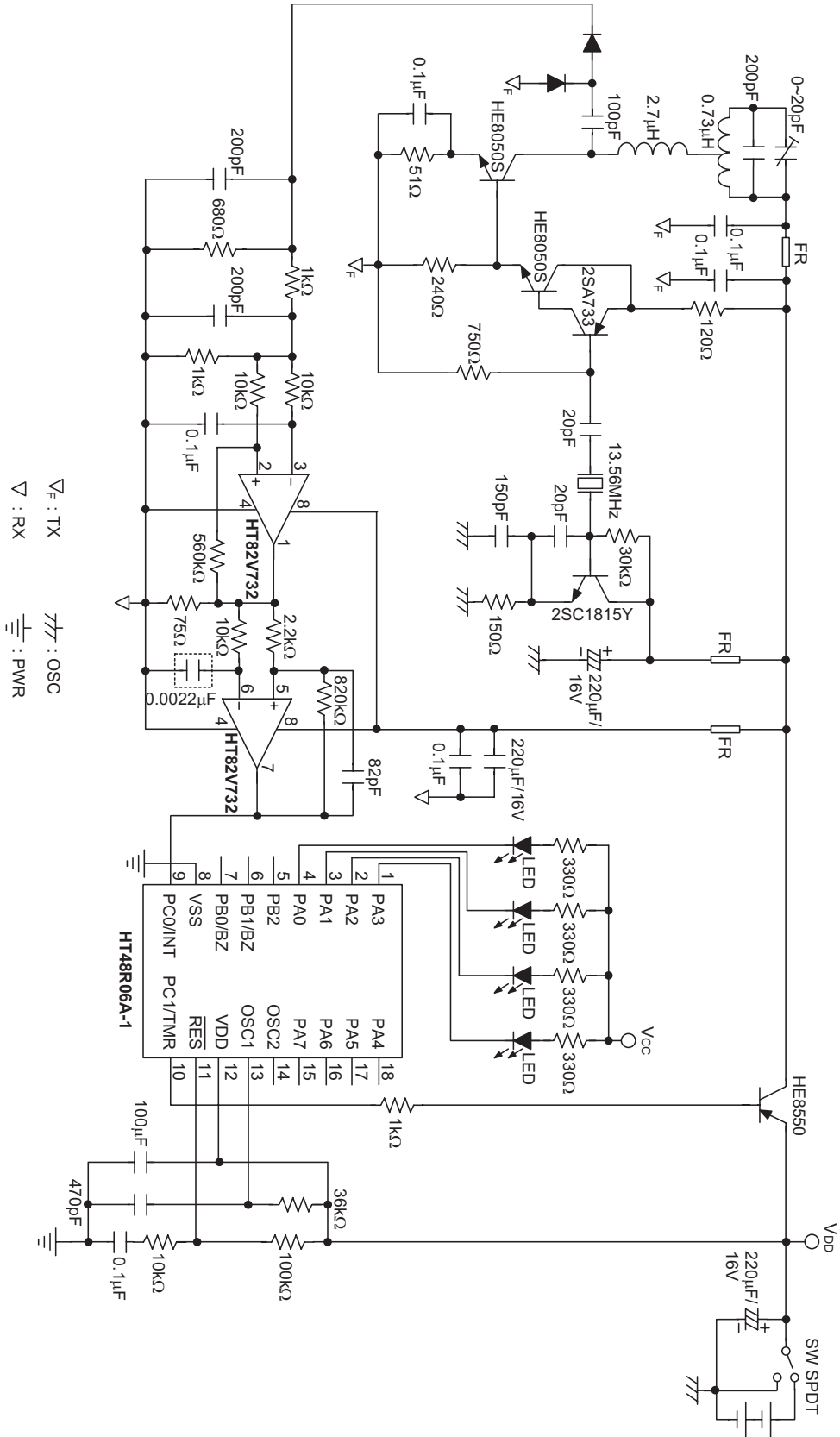

**Package Information**

**8-pin DIP (300mil) Outline Dimensions**

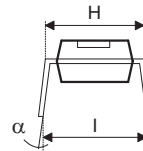
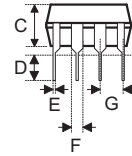
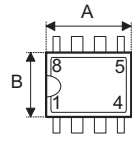

Symbol	Dimensions in mil		
	Min.	Nom.	Max.
A	355	—	375
B	240	—	260
C	125	—	135
D	125	—	145
E	16	—	20
F	50	—	70
G	—	100	—
H	295	—	315
I	335	—	375
$\alpha$	0°	—	15°

**Holtek Semiconductor Inc. (Headquarters)**

No.3, Creation Rd. II, Science Park, Hsinchu, Taiwan  
Tel: 886-3-563-1999  
Fax: 886-3-563-1189  
<http://www.holtek.com.tw>

**Holtek Semiconductor Inc. (Taipei Sales Office)**

4F-2, No. 3-2, YuanQu St., Nankang Software Park, Taipei 115, Taiwan  
Tel: 886-2-2655-7070  
Fax: 886-2-2655-7373  
Fax: 886-2-2655-7383 (International sales hotline)

**Holtek Semiconductor Inc. (Shanghai Sales Office)**

7th Floor, Building 2, No.889, Yi Shan Rd., Shanghai, China 200233  
Tel: 86-21-6485-5560  
Fax: 86-21-6485-0313  
<http://www.holtek.com.cn>

**Holtek Semiconductor Inc. (Shenzhen Sales Office)**

5/F, Unit A, Productivity Building, Cross of Science M 3rd Road and Gaoxin M 2nd Road, Science Park, Nanshan District, Shenzhen, China 518057  
Tel: 86-755-8616-9908, 86-755-8616-9308  
Fax: 86-755-8616-9722

**Holtek Semiconductor Inc. (Beijing Sales Office)**

Suite 1721, Jinyu Tower, A129 West Xuan Wu Men Street, Xicheng District, Beijing, China 100031  
Tel: 86-10-6641-0030, 86-10-6641-7751, 86-10-6641-7752  
Fax: 86-10-6641-0125

**Holtek Semiconductor Inc. (Chengdu Sales Office)**

709, Building 3, Champagne Plaza, No.97 Dongda Street, Chengdu, Sichuan, China 610016  
Tel: 86-28-6653-6590  
Fax: 86-28-6653-6591

**Holtek Semiconductor (USA), Inc. (North America Sales Office)**

46729 Fremont Blvd., Fremont, CA 94538  
Tel: 1-510-252-9880  
Fax: 1-510-252-9885  
<http://www.holtek.com>

Copyright © 2007 by HOLTEK SEMICONDUCTOR INC.

The information appearing in this Data Sheet is believed to be accurate at the time of publication. However, Holtek assumes no responsibility arising from the use of the specifications described. The applications mentioned herein are used solely for the purpose of illustration and Holtek makes no warranty or representation that such applications will be suitable without further modification, nor recommends the use of its products for application that may present a risk to human life due to malfunction or otherwise. Holtek's products are not authorized for use as critical components in life support devices or systems. Holtek reserves the right to alter its products without prior notification. For the most up-to-date information, please visit our web site at <http://www.holtek.com.tw>.