



AKD4363

Evaluation board Rev.A for AK4363

GENERAL DESCRIPTION

The AKD4363 is an evaluation board for AK4363, 96kHz 24bit D/A converter with PLL. The AKD4363 has a digital interface with AKM's wave generator using ROM data and AKM's A/D converter evaluation boards. Therefore, it is easy to evaluate the AK4363.

■ Ordering guide

AKD4363 --- Evaluation board for AK4363
 (Cable for connecting with printer port of IBM-AT compatible PC
 and control software are packed with this.)

FUNCTION

- On-board clock generator
- Compatible with 2 types of interface
 - Direct interface with AKM's A/D converter evaluation boards
and direct interface with AKM's signal generator(AKD43XX) by 10pin header
 - On-board CS8414 as DIR which accepts optical input
- BNC connector for external clock input
- 10pin header for serial control interface
- On-board mute circuit for analog output

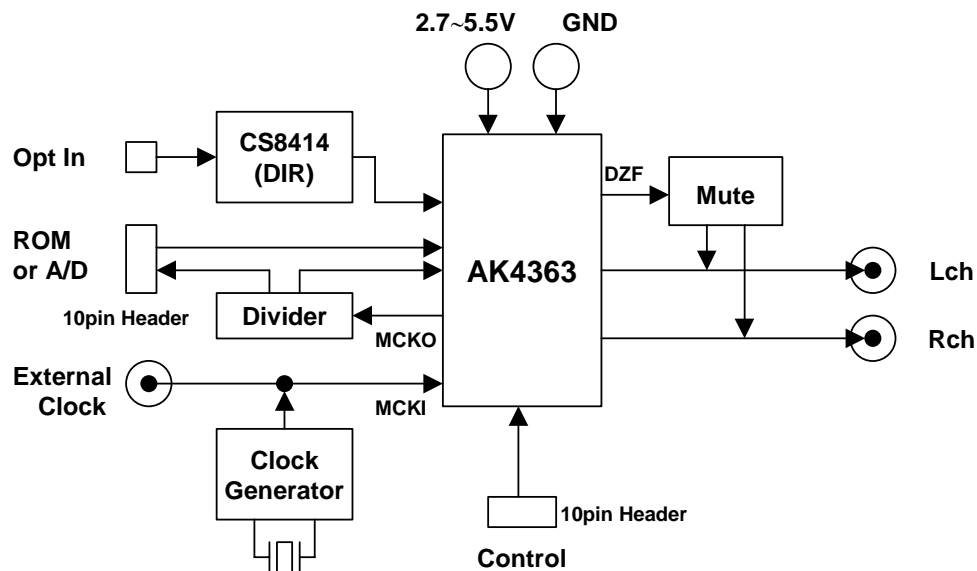

Figure 1. AKD4363 Block Diagram

* Circuit diagram and PCB layout are attached at the end of this manual.

■ External analog circuit

J1(AOUTL) and J2(AOUTR) are used. The analog output signal range is nominally 3.1Vpp@5V. It is proportional to AVDD ($V_{out}=0.62 \times AVDD$).

■ Operation sequence

- 1) Set up the power supply lines.
 - [AVDD] (red) = 2.7~5.5V : for AVDD of AK4363
 - [3V] (orange) = 2.7~5.5V : for DVDD of AK4363
 - [5V] (red) = 3.4~5.5V : for logic
 - [AGND] (black)= 0V : for analog ground (including AVSS and DVSS of AK4363)
 - [DGND] (black)= 0V : for logic ground

Each supply line should be distributed from the power supply unit.

- 2) Set up the evaluation mode, jumper pins and DIP switches. (See the followings.)

- 3) Power on.
 - The AK4363 should be reset once bringing SW1(-PD) "L" upon power-up.

- 4) Connect PORT2 with PC.
 - Connect PORT2 with printer port (parallel port) of IBM-AT compatible PC by 10-line flat cable packed with the AKD4363. Take care of the direction of connector. There is a mark at 1pin. The direction of PORT2 is as the following figure.

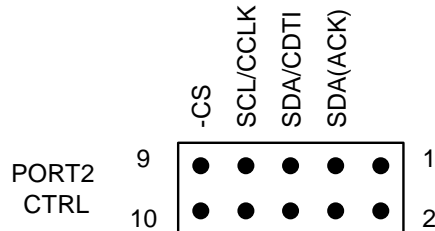

- 5) Set up the software.
 - Use the software named "AKD4363 Control Program" packed with the AKD4363.

■ Evaluation mode

- 1) Using A/D converted data <default>
 - PORT3 (ADC/ROM) is used to interface with various AKM's A/D converter evaluation boards. In case of using external clock through a BNC connector (J4), select BNC on JP14 (CLK) and short JP15 (XTE).



2) Ideal sine wave generated by ROM data

Digital signals generated by AKD43XX are used. PORT3 (ADC/ROM) is used to interface with AK43XX. Master clock is sent from AKD4363 to AKD43XX and LRCK, BICK, SDTI are supplied from AKD43XX to AKD4363. In case of using external clock through a BNC connector (J4), select "BNC" on JP14 (CLK) and short JP15 (XTE).

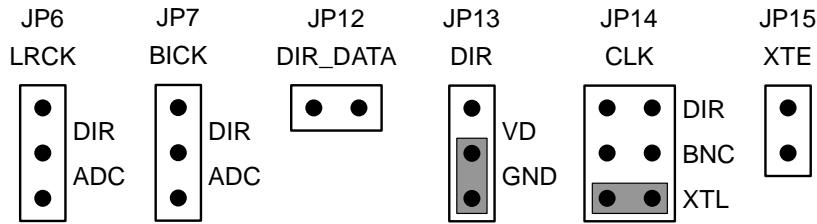

3) DIR(CS8414)

PORT4 (TORX174) is used for the evaluation using such as test disk. The DIR generates MCKI, BICK, LRCK, SDTI from the received data through optical connector. In this case, the EXT bit of AK4363 should be "1" (External clock mode). Select "RCA" or "OPT" on JP16 (RCA/OPT) in case of using RCA connector (J3) or optical connector (PORT4: TORX174).



■ Clock (MCLK,BICK,LRCK) set up

In case of using evaluation mode 1), JP9,10 and 17 should be set up as follows. They need no care for other evaluation mode.

MCLK	JP9 (X_MCLK)	JP10 (X_LRCK)	BICK	JP17 (X_BICK)	
128fs	x1	x1/128	32fs 64fs 128fs	x1/4 x1/2 x1	default
256fs	x1	x1/256	32fs 64fs 128fs	x1/8 x1/4 x1/2	
512fs	x2	x1/256	32fs 64fs 128fs	x1/8 x1/4 x1/2	
1024fs	x4	x1/256	32fs 64fs 128fs	x1/8 x1/4 x1/2	

Table 1. Clock set up

■ DIP switch (SW2) set up

No.1 to 5 set the mode of AK4363 and No.6 to 8 set the mode of CS8414.

No.	Pin	OFF <default>	ON
1	CAD1	Chip address (2bit)	
2	CAD0		
3	I2C	3-wire serial	I2C bus
4	TTL	CMOS level	TTL level
5	TST	always "OFF"	-
6	M2	Digital interface format of CS8414 (See table 3.) (Note)	
7	M1		
8	M0		

Table 2. DIP switch set-up

(Note: M2-0 should be selected at only evaluation mode 3.
In other mode, these should be "OFF".)

Mode	Format	M2	M1	M0	JP9	DIF 2	DIF 1	DIF 0
0	16bit, LSB justified	1	0	1	THR	0	0	0
1	18bit, LSB justified	1	1	0	THR	0	0	1
2	20bit, LSB justified	-	-	-	-	0	1	0
3	24bit, LSB justified	-	-	-	-	0	1	1
4	24bit, MSB justified	0	0	0	INV	1	0	0
5	I2S	0	1	0	THR	1	0	1

Table 3. Digital interface format set-up

(Note: 1="ON", 0="OFF".

DIF2-0 should be selected by serial control.

CS8414 does not correspond to 20/24bit LSB justified format.)

■ Other jumper pins set up

[JP1](GND): Analog ground and digital ground

Open: Separated <default>

Short: Common (The connector "DGND" can be open.)

[JP2](5V-3V): DVDD of AK4363 and power supply to logic

Open: Independent <default>

Short: Same (The connector "3V" should be open.)

[JP3](DVDD): DVDD of AK4363

3V: Independent of AVDD <default>

AVDD: Same as AVDD (The connector "3V" can be open.)

[JP5](DZF): Mute circuit

ON: Used (Analog output is muted when DZF="H".) <default>

OFF: Not used

[JP11](SDTI): SDTI of AK4363

DATA: Data is input <default>

GND: "0" data is input

■ The function of the toggle SW (SW1)

Upper-side is “H” and lower-side is “L”.

[SW1] (-PD): Resets the AK4363. Keep “H” during normal operation.

■ The indication content for LED

[LED1] (VERF): Monitors VERF pin of the CS8414. LED turns on when some error has occurred to CS8414.

[LED2] (PREM): Indicates whether the input data is pre-emphasis or not.
LED turns on when the data is pre-emphasised.

Control Software Manual

■ Set-up of evaluation board and control software

1. Set up the AKD4363 Rev.A according to previous term.
2. Connect IBM-AT compatible PC with AKD4363 Rev.A by 10-line type flat cable (packed with AKD4363 Rev.A). Take care of the direction of 10pin header. (Please install the driver in the CD-ROM when this control software is used on Windows 2000/XP. Please refer "Installation Manual of Control Software Driver by AKM device control software". In case of Windows95/98/ME, this installation is not needed. This control software does not operate on Windows NT.)
3. Insert the CD-ROM labeled "AKD4363 Rev.A Evaluation Kit" into the CD-ROM drive.
4. Access the CD-ROM drive and double-click the icon of "akd4363.exe" to set up the control program.
5. Then please evaluate according to the follows.

■ Operation flow

Keep the following flow.

1. Set up the control program according to explanation above.
2. Click "Port Reset" button.

■ Explanation of each buttons

1. [Port Reset] : Set up the USB interface board (AKDUSBIF-A) .
2. [Write default] : Initialize the register of AK4363.
3. [All Write] : Write all registers that is currently displayed.
4. [Function1] : Dialog to write data by keyboard operation.
5. [Function2] : Dialog to write data by keyboard operation.
6. [Function3] : The sequence of register setting can be set and executed.
7. [Function4] : The sequence that is created on [Function3] can be assigned to buttons and executed.
8. [Function5]: The register setting that is created by [SAVE] function on main window can be assigned to buttons and executed.
9. [SAVE] : Save the current register setting.
10. [OPEN] : Write the saved values to all register.
11. [Write] : Dialog to write data by mouse operation.

■ Indication of data

Input data is indicated on the register map. Red letter indicates "H" or "1" and blue one indicates "L" or "0". Blank is the part that is not defined in the datasheet.

■ Explanation of each dialog

1. [Write Dialog]: Dialog to write data by mouse operation

There are dialogs corresponding to each register.

Click the [Write] button corresponding to each register to set up the dialog. If you check the check box, data becomes “H” or “1”. If not, “L” or “0”.

If you want to write the input data to AK4363, click [OK] button. If not, click [Cancel] button.

2. [Function1 Dialog] : Dialog to write data by keyboard operation

Address Box: Input registers address in 2 figures of hexadecimal.

Data Box: Input registers data in 2 figures of hexadecimal.

If you want to write the input data to AK4363, click [OK] button. If not, click [Cancel] button.

3. [Function2 Dialog] : Dialog to evaluate ATT

Address Box: Input registers address in 2 figures of hexadecimal.

Start Data Box: Input starts data in 2 figures of hexadecimal.

End Data Box: Input end data in 2 figures of hexadecimal.

Interval Box: Data is written to AK4642 by this interval.

Step Box: Data changes by this step.

Mode Select Box:

If you check this check box, data reaches end data, and returns to start data.

[Example] Start Data = 00, End Data = 09

Data flow: 00 01 02 03 04 05 06 07 08 09 09 08 07 06 05 04 03 02 01 00

If you do not check this check box, data reaches end data, but does not return to start data.

[Example] Start Data = 00, End Data = 09

Data flow: 00 01 02 03 04 05 06 07 08 09

If you want to write the input data to AK4363, click [OK] button. If not, click [Cancel] button.

4. [Save] and [Open]

4-1. [Save]

Save the current register setting data. The extension of file name is “akr”.

(Operation flow)

- (1) Click [Save] Button.
- (2) Set the file name and push [Save] Button. The extension of file name is “akr”.

4-2. [Open]

The register setting data saved by [Save] is written to AK4363. The file type is the same as [Save].

(Operation flow)

- (1) Click [Open] Button.
- (2) Select the file (*.akr) and Click [Open] Button.

5. [Function3 Dialog]

The sequence of register setting can be set and executed.

(1) Click [F3] Button.

(2) Set the control sequence.

Set the address, Data and Interval time. Set “-1” to the address of the step where the sequence should be paused.

(3) Click [Start] button. Then this sequence is executed.

The sequence is paused at the step of Interval="-1". Click [START] button, the sequence restarts from the paused step.

This sequence can be saved and opened by [Save] and [Open] button on the Function3 window. The extension of file name is “aks”.

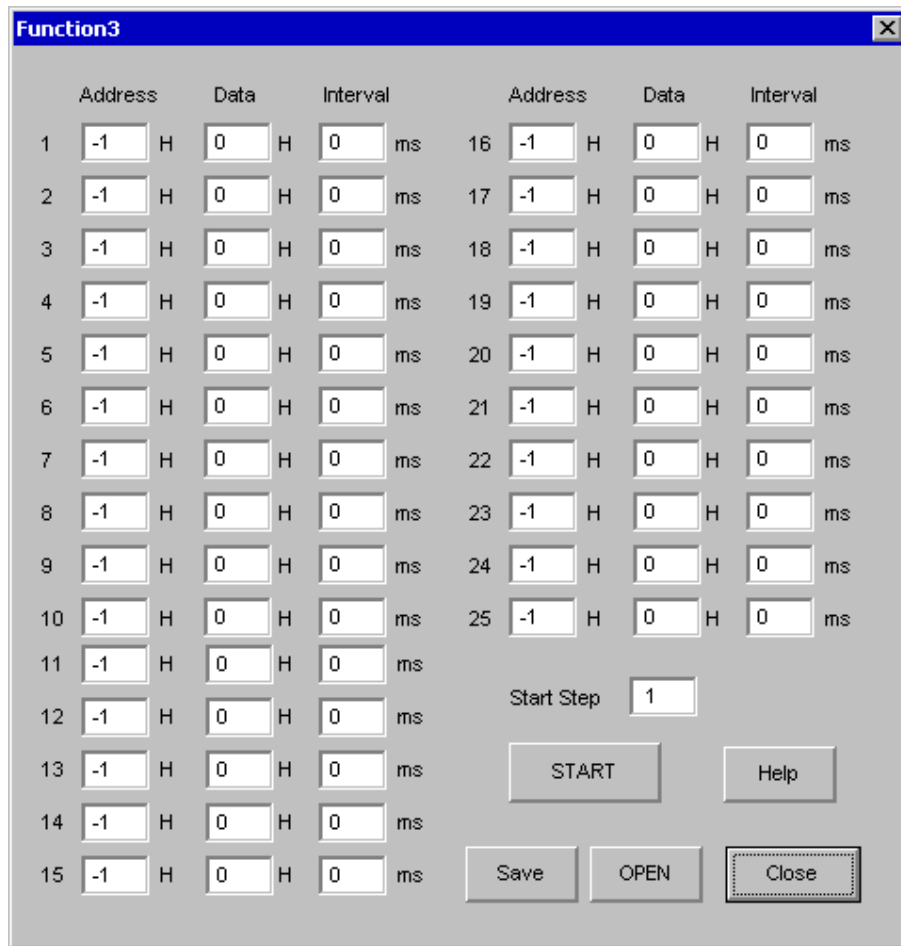

Figure 1. Window of [F3]

6. [Function4 Dialog]

The sequence that is created on [Function3] can be assigned to buttons and executed. When [F4] button is clicked, the window as shown in Figure 2 opens.

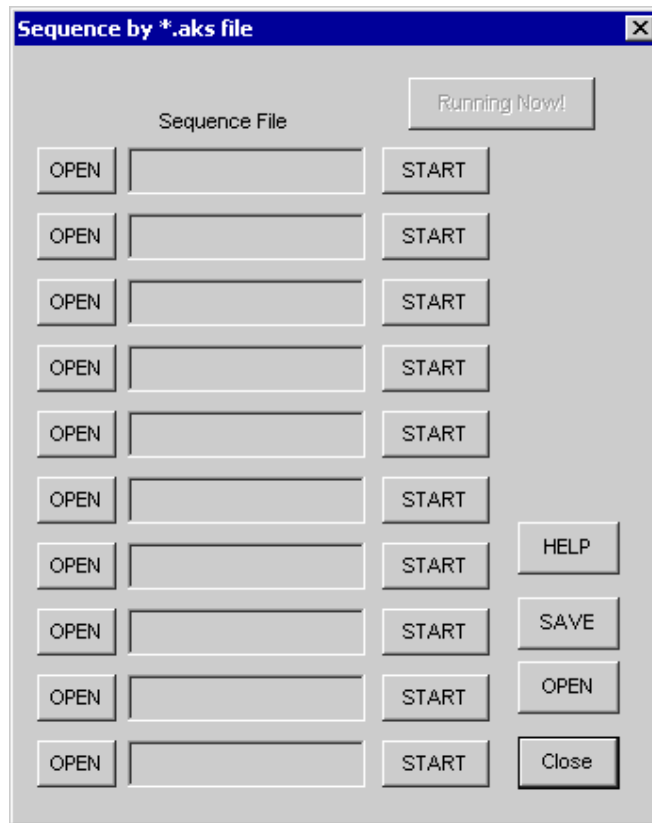

Figure 2. [F4] window

6-1. [OPEN] buttons on left side and [START] buttons

(1) Click [OPEN] button and select the sequence file (*.aks).

The sequence file name is displayed as shown in Figure 3.

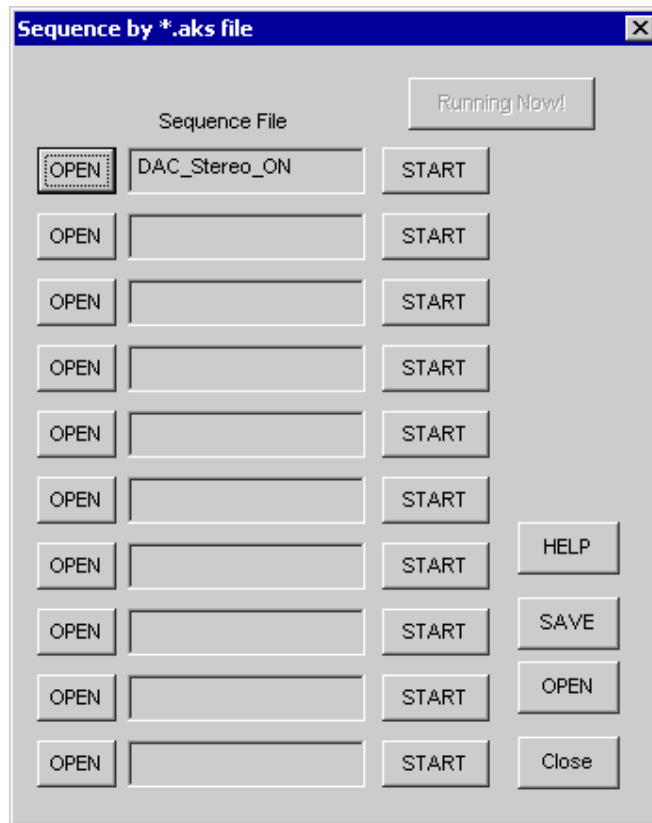

Figure 3. [F4] window(2)

(2) Click [START] button, then the sequence is executed.

3-2. [SAVE] and [OPEN] buttons on right side

[SAVE] : The sequence file names can assign be saved. The file name is *.ak4.

[OPEN] : The sequence file names assign that are saved in *.ak4 are loaded.

3-3. Note

- (1) This function doesn't support the pause function of sequence function.
- (2) All files need to be in same folder used by [SAVE] and [OPEN] function on right side.
- (3) When the sequence is changed in [Function3], the file should be loaded again in order to reflect the change.

7. [Function5 Dialog]

The register setting that is created by [SAVE] function on main window can be assigned to buttons and executed. When [F5] button is clicked, the following window as shown in Figure 4 opens.

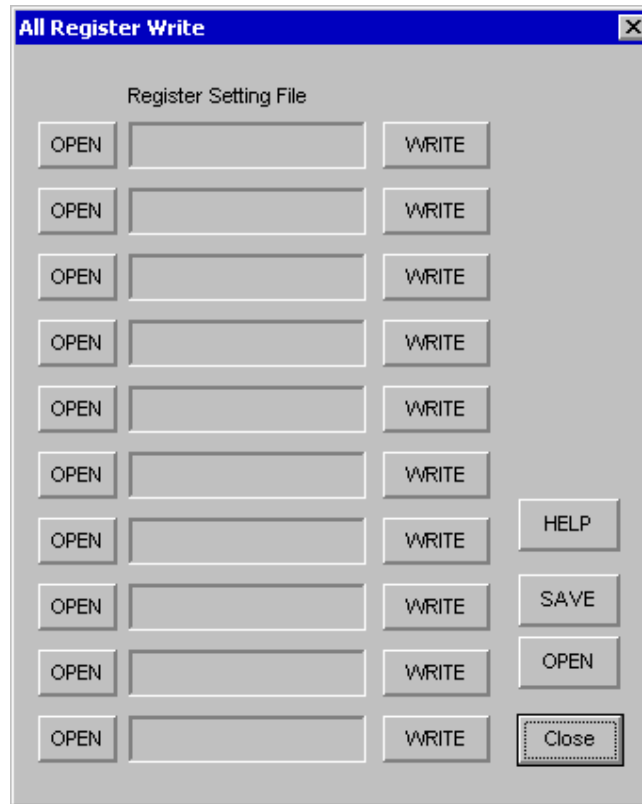

Figure 4. [F5] window

7-1. [OPEN] buttons on left side and [WRITE] button

- (1) Click [OPEN] button and select the register setting file (*.akr).
- (2) Click [WRITE] button, then the register setting is executed.

7-2. [SAVE] and [OPEN] buttons on right side

[SAVE] : The register setting file names assign can be saved. The file name is *.ak5.

[OPEN] : The register setting file names assign that are saved in *.ak5 are loaded.

7-3. Note

- (1) All files need to be in same folder used by [SAVE] and [OPEN] function on right side.
- (2) When the register setting is changed by [Save] Button in main window, the file should be loaded again in order to reflect the change.

MEASUREMENT RESULTS

[Measurement condition]

- Measurement unit : ROHDE & SCHWARZ, UPD04
- MCLK : 256fs
- BICK : 64fs
- fs : 44.1kHz, 96kHz
- BW : 20Hz~20kHz (fs=44.1kHz), 20Hz~40kHz (fs=96kHz)
- Bit : 24bit
- Power Supply : AVDD=DVDD=5V
- Interface : DIR (EXT mode, fs=44.1kHz), Serial Multiplex (EXT mode, fs=96kHz; PLL mode)
- Temperature : Room

fs=44.1kHz

Parameter	Input signal	Measurement filter	EXT	PLL
S/(N+D)	1kHz, 0dB	20kLPF	97.0dB	88.9dB
DR	1kHz, -60dB	20kLPF	99.0dB	98.4dB
		20kLPF, A-weighted	102.3dB	101.9dB
S/N	no signal	20kLPF	99.0dB	98.4dB
		20kLPF, A-weighted	102.3dB	101.9dB

fs=96kHz

Parameter	Input signal	Measurement filter	EXT	PLL
S/(N+D)	1kHz, 0dB	40kLPF	92.5dB	84.9dB
DR	1kHz, -60dB	40kLPF	97.0dB	95.9dB
		20kLPF, A-weighted	101.5dB	101.9dB
S/N	no signal	40kLPF	97.0dB	95.9dB
		20kLPF, A-weighted	101.5dB	101.9dB

[Measurement condition]

- Measurement unit : Audio Precision, System two, Cascade
- MCLK : 256fs
- BICK : 64fs
- fs : 44.1kHz, 96kHz
- BW : 10Hz~20kHz (fs=44.1kHz), 10Hz~40kHz (fs=96kHz)
- Bit : 24bit
- Power Supply : AVDD=DVDD=5V
- Interface : DIR
- Temperature : Room

fs=44.1kHz

Parameter	Input signal	Measurement filter	EXT
S/(N+D)	1kHz, 0dB	20kLPF	97.4dB
DR	1kHz, -60dB	20kLPF	98.8dB
		22kLPF, A-weighted	101.6dB
S/N	no signal	20kLPF	98.6dB
		22kLPF, A-weighted	101.8dB

fs=96kHz

Parameter	Input signal	Measurement filter	EXT
S/(N+D)	1kHz, 0dB	40kLPF	94.5dB
DR	1kHz, -60dB	40kLPF	96.9dB
		22kLPF, A-weighted	101.9dB
S/N	no signal	40kLPF	96.8dB
		22kLPF, A-weighted	101.9dB

PLOTS

[Measurement condition]

- Measurement unit : ROHDE & SCHWARZ, UPD04 (for PLL mode),
Audio Precision, System two (for EXT mode)
- MCLK : 256fs
- BICK : 64fs
- fs : 44.1kHz, 96kHz
- Bit : 24bit
- Power Supply : AVDD=DVDD=5V
- Interface : Serial Multiplexer (for PLL mode), DIR (for EXT mode)
- Temperature : Room

[Contents]

1. PLL mode

1-1. fs=44.1kHz

- Figure 1-1-1. THD+N vs. Input level
- Figure 1-1-2. THD+N vs. Input frequency
- Figure 1-1-3. Linearity
- Figure 1-1-4. Frequency response
- Figure 1-1-5. Cross-talk
- Figure 1-1-6. FFT (1kHz, 0dBFS)
- Figure 1-1-7. FFT (1kHz, -60dBFS)
- Figure 1-1-8. FFT (noise floor)
- Figure 1-1-9. FFT (out-of-band noise, ~300kHz)

1-2. fs=96kHz

- Figure 1-2-1. THD+N vs. Input level
- Figure 1-2-2. THD+N vs. Input frequency
- Figure 1-2-3. Linearity
- Figure 1-2-4. Frequency response

2. EXT mode

2-1. fs=44.1kHz

- Figure 2-1-1. THD+N vs. Input level
- Figure 2-1-2. THD+N vs. Input frequency
- Figure 2-1-3. Linearity
- Figure 2-1-4. Frequency response
- Figure 2-1-5. Cross-talk
- Figure 2-1-6. FFT (1kHz, 0dBFS)
- Figure 2-1-7. FFT (1kHz, -60dBFS)
- Figure 2-1-8. FFT (noise floor)
- Figure 2-1-9. FFT (out-of-band noise, ~80kHz)

2-2. fs=96kHz

- Figure 2-2-1. THD+N vs. Input level
- Figure 2-2-2. THD+N vs. Input frequency
- Figure 2-2-3. Linearity
- Figure 2-2-4. Frequency response

1. PLL mode
1-1. fs=44.1kHz

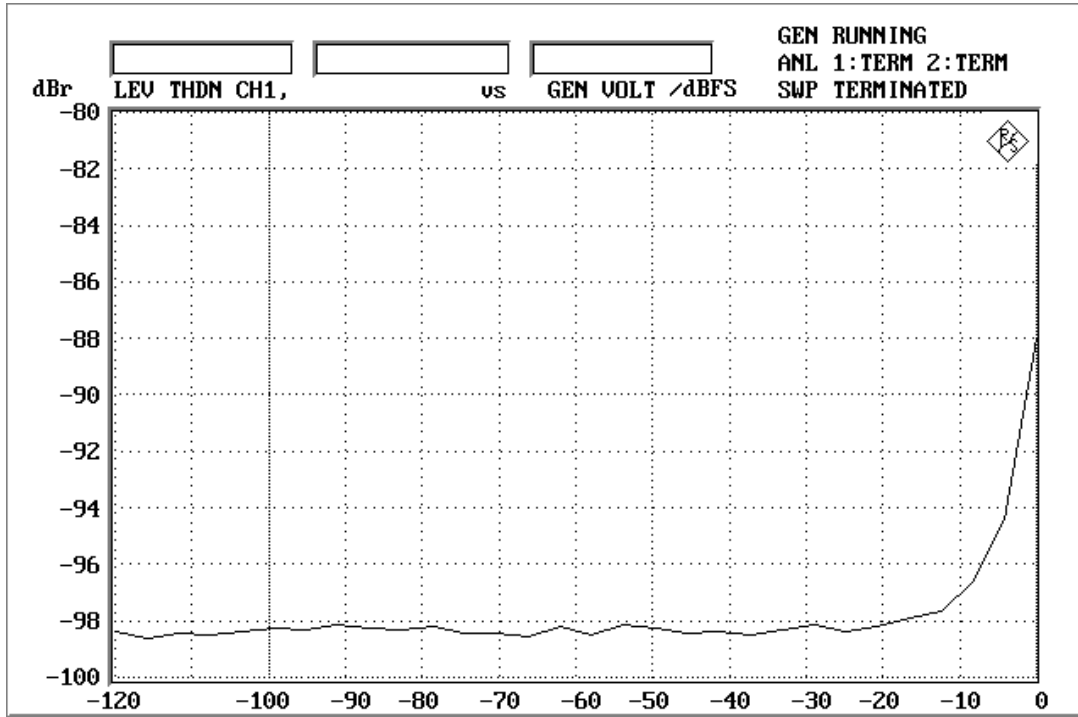

Figure 1-1-1. THD+N vs. Input level

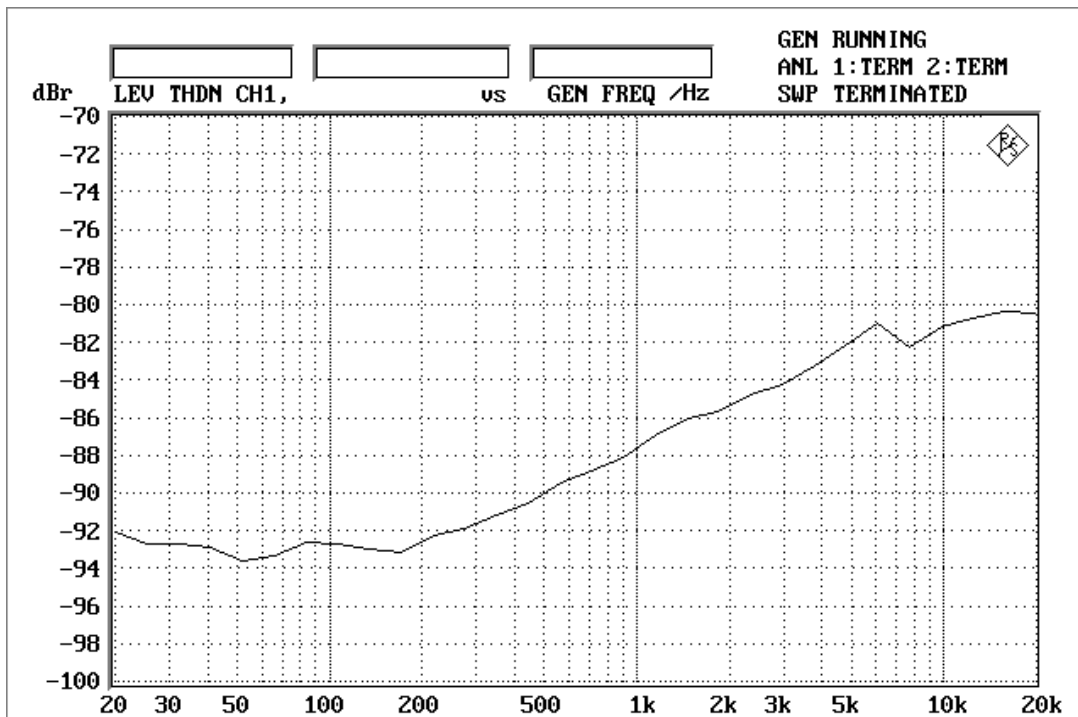

Figure 1-1-2. THD+N vs. Input frequency

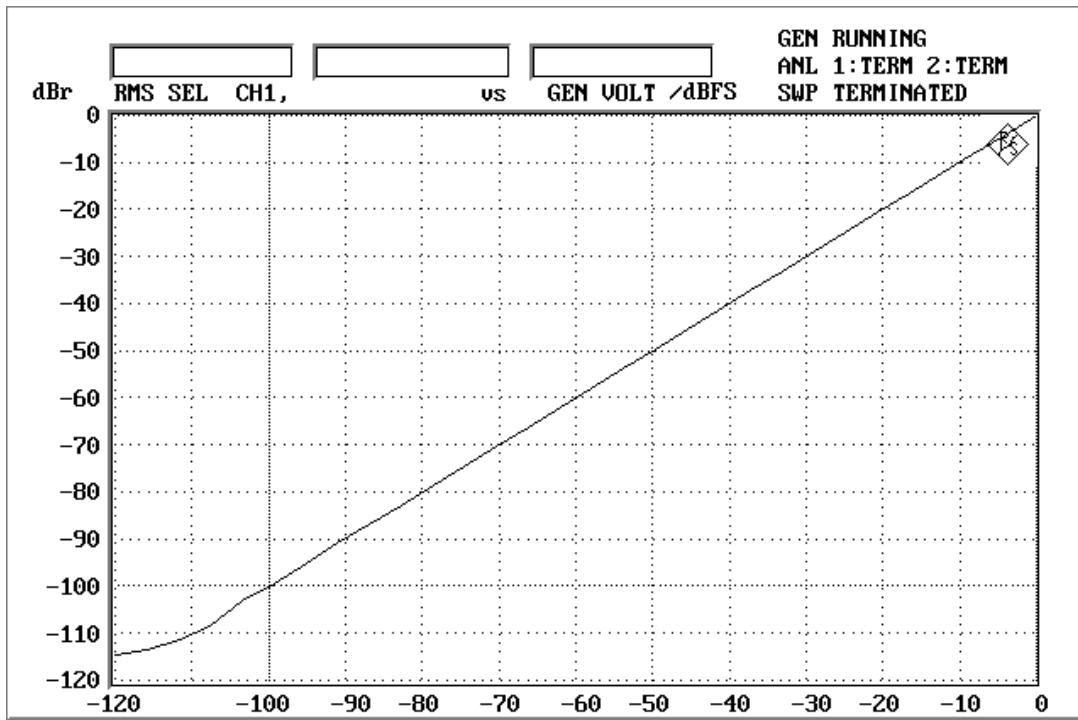

Figure 1-1-3. Linearity

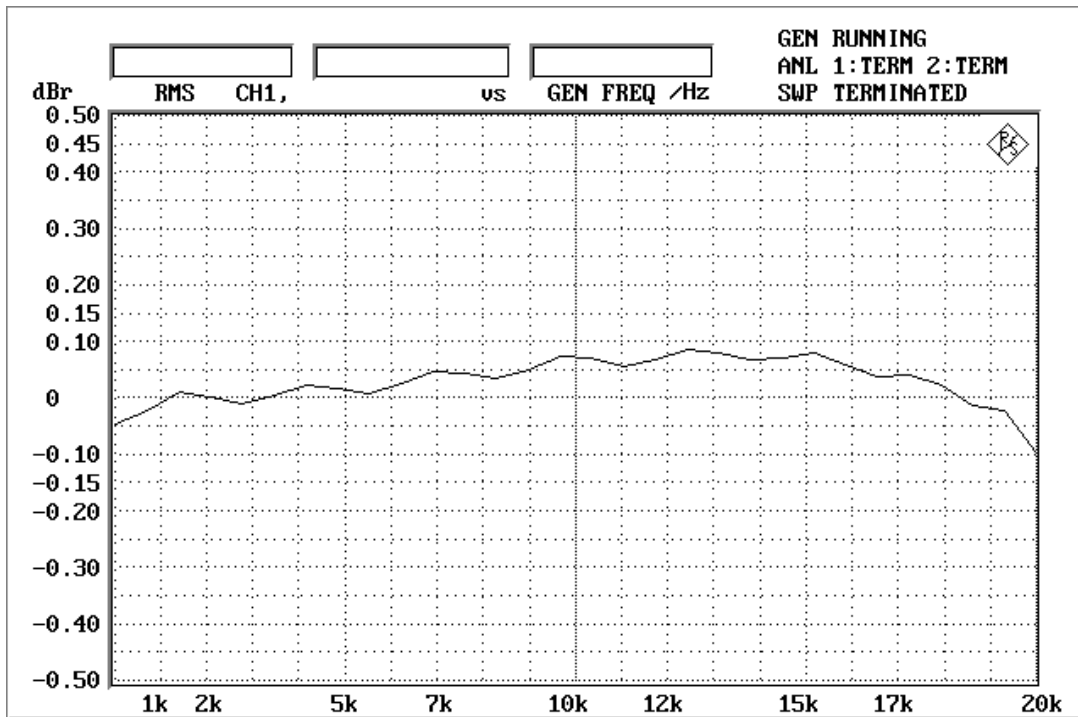

Figure 1-1-4. Frequency response

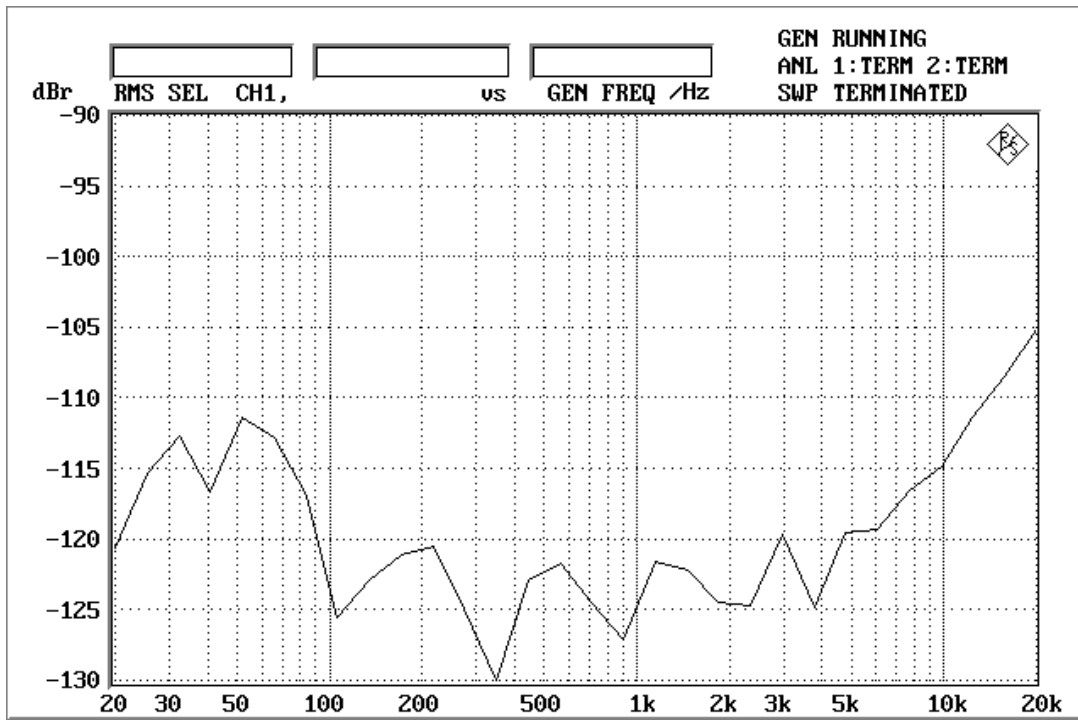

Figure 1-1-5. Cross-talk

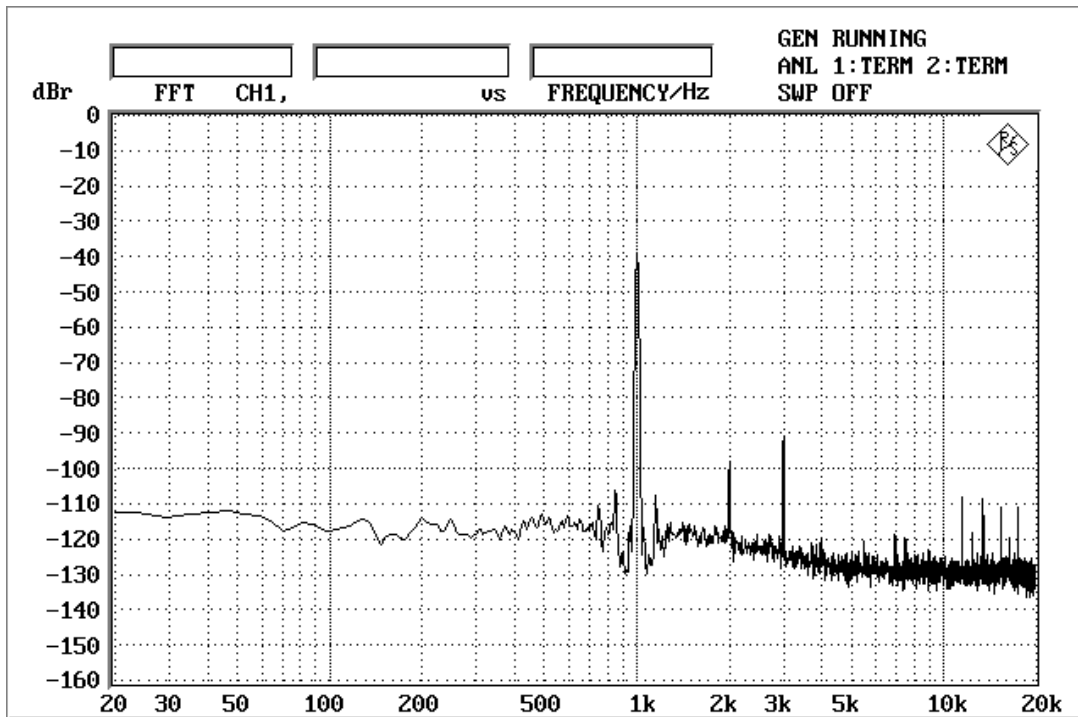

Figure 1-1-6. FFT (1kHz, 0dBFS)
FFT points=8192, Avg=8, Notch=-30dB

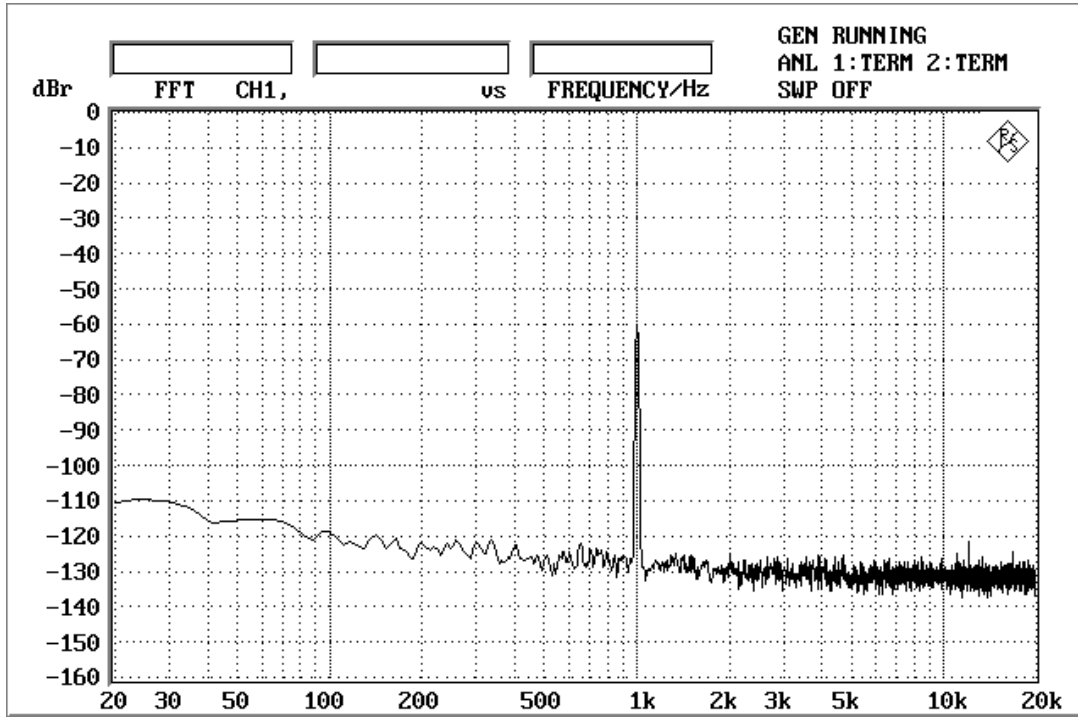

Figure 1-1-7. FFT (1kHz, -60dBFS)
FFT points=8192, Avg=8

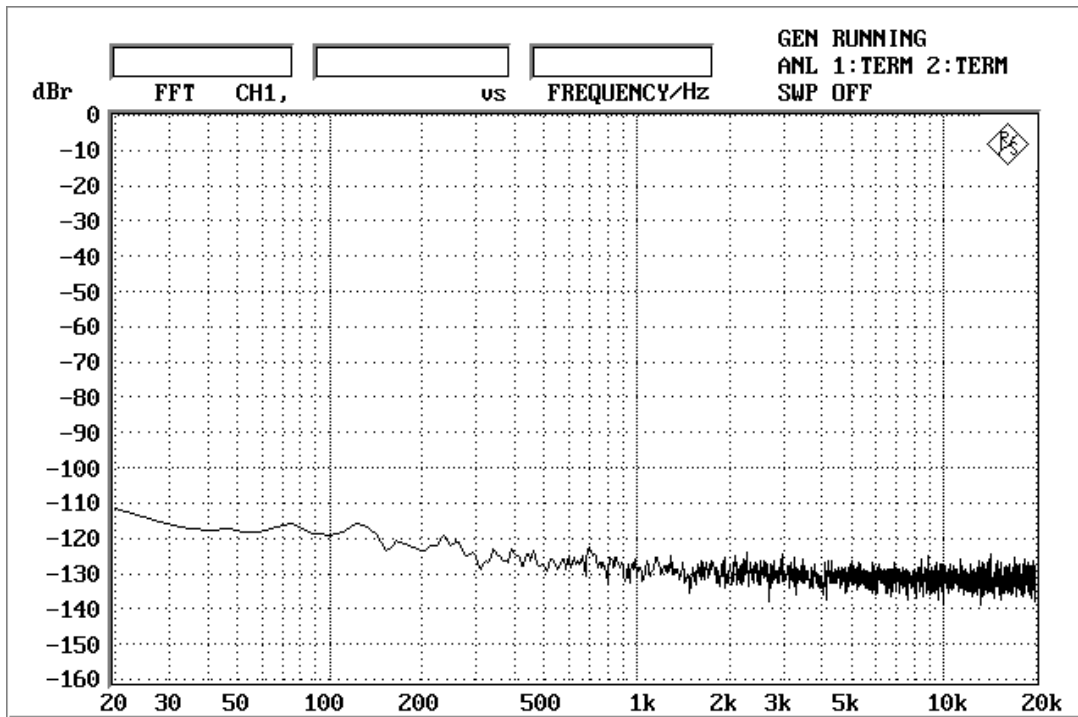

Figure 1-1-8. FFT (noise floor)
FFT points=8192, Avg=8

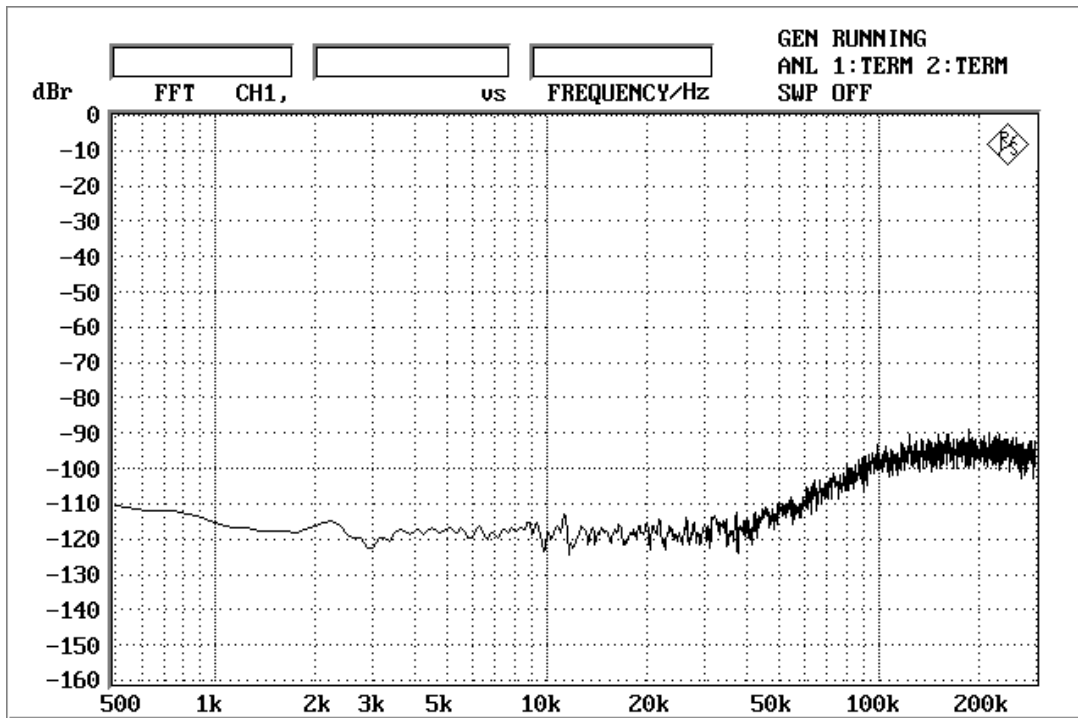

Figure 1-1-9. FFT (out-of-band noise)
FFT points=8192, Avg=8

1-2. fs=96kHz

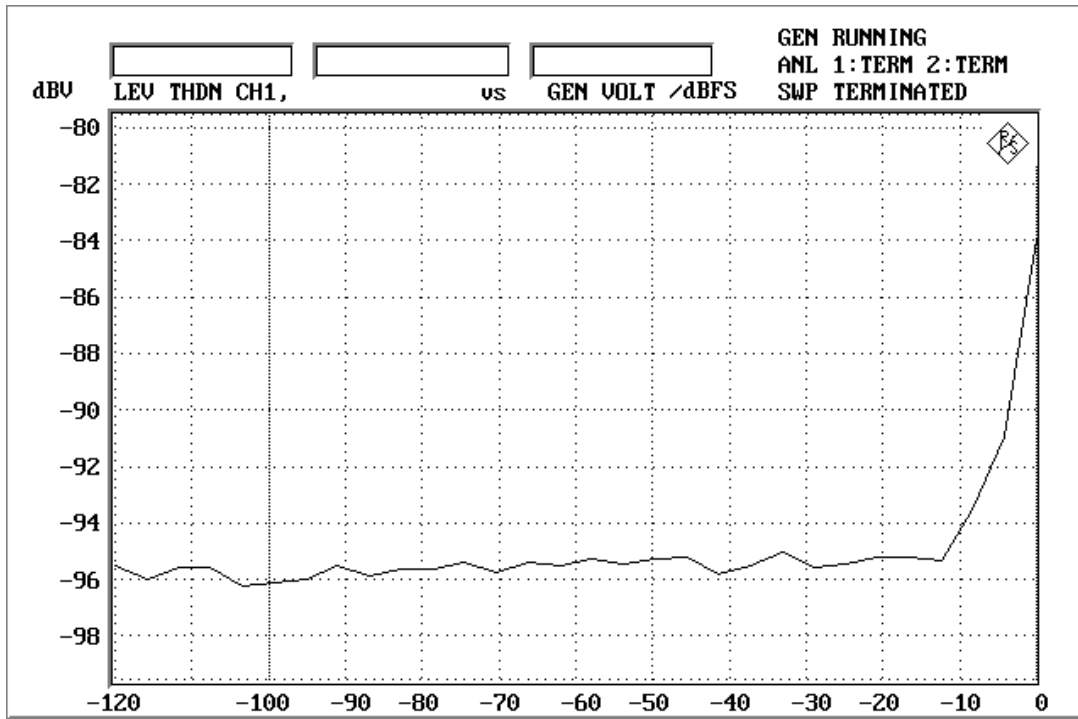

Figure 1-2-1. THD+N vs. Input level

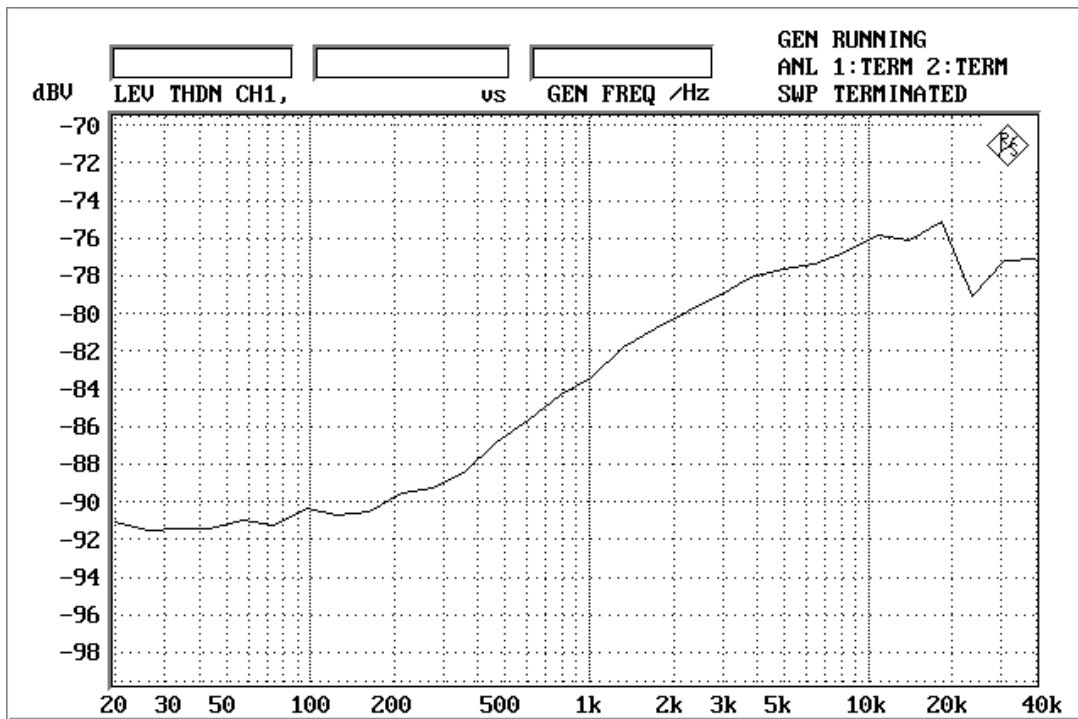

Figure 1-2-2. THD+N vs. Input frequency

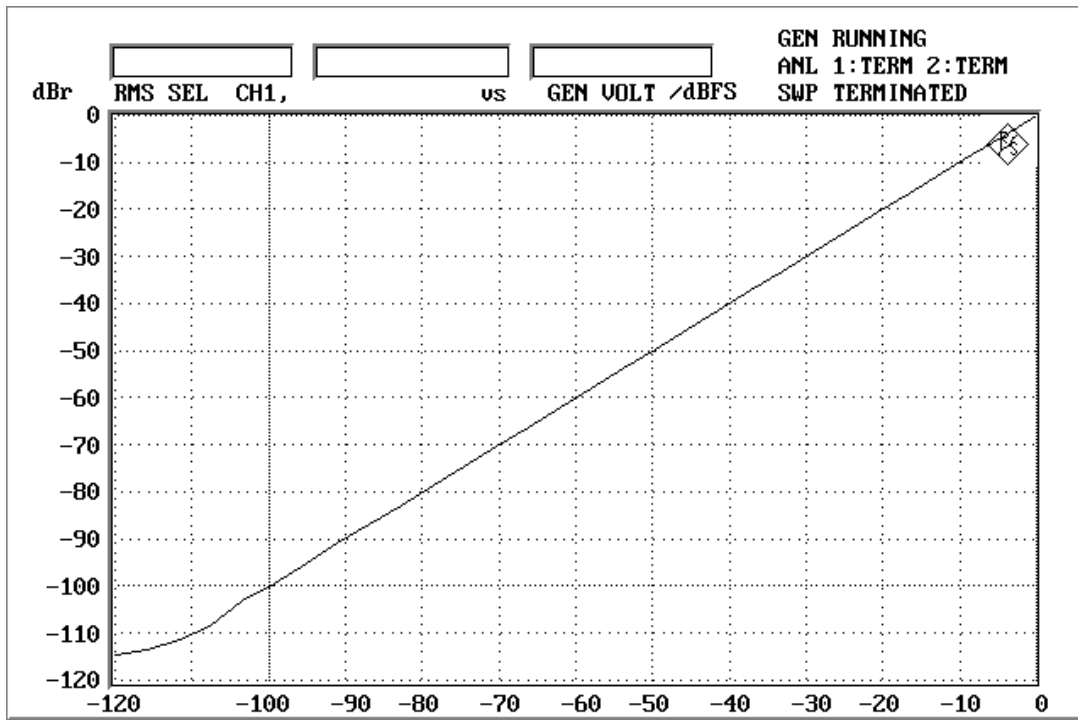

Figure 1-2-3. Linearity

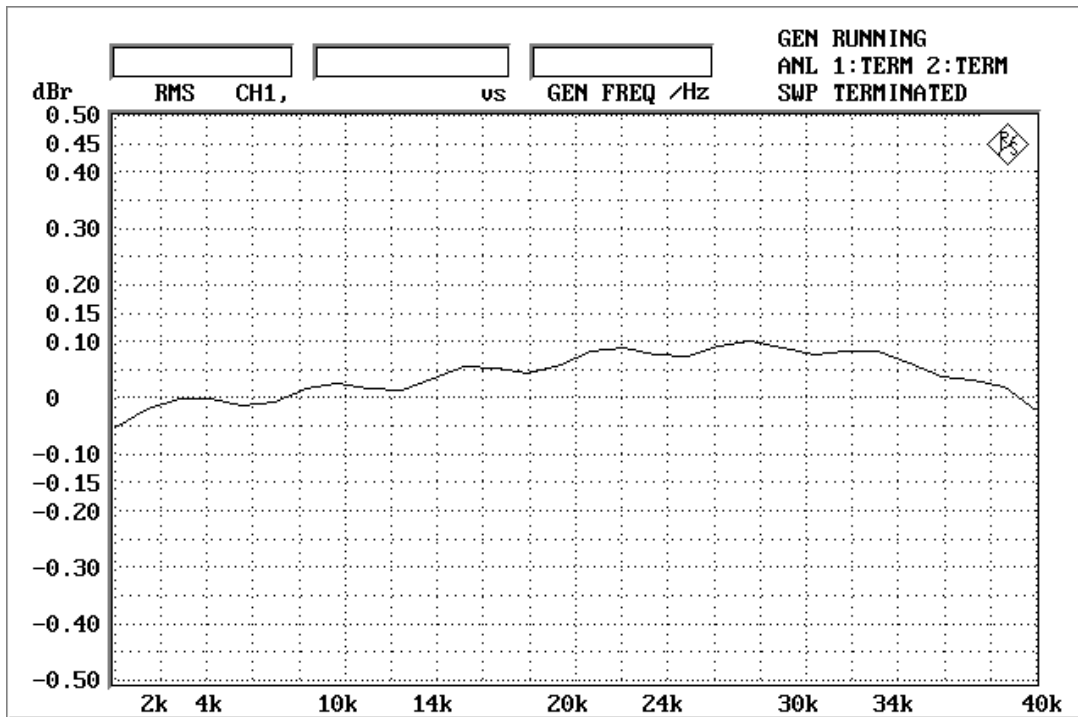

Figure 1-2-4. Frequency response

2. EXT mode
2-1. fs=44.1kHz

AKM AK4353 THD+N vs Input Level (AVDD=DVDD=5V, fs=44.1kHz, fin=1kHz)

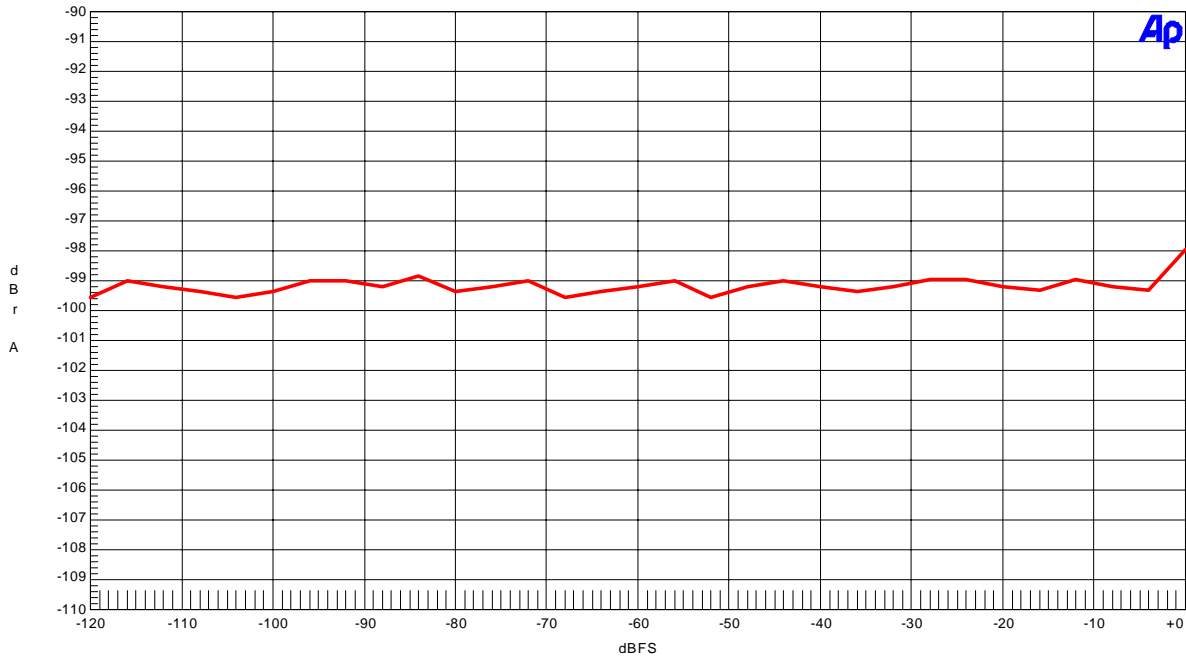

Figure 2-1-1. THD+N vs. Input level

AKM AK4353 THD+N vs fin (AVDD=DVDD=5V, fs=44.1kHz, Input Level=0dBFS)

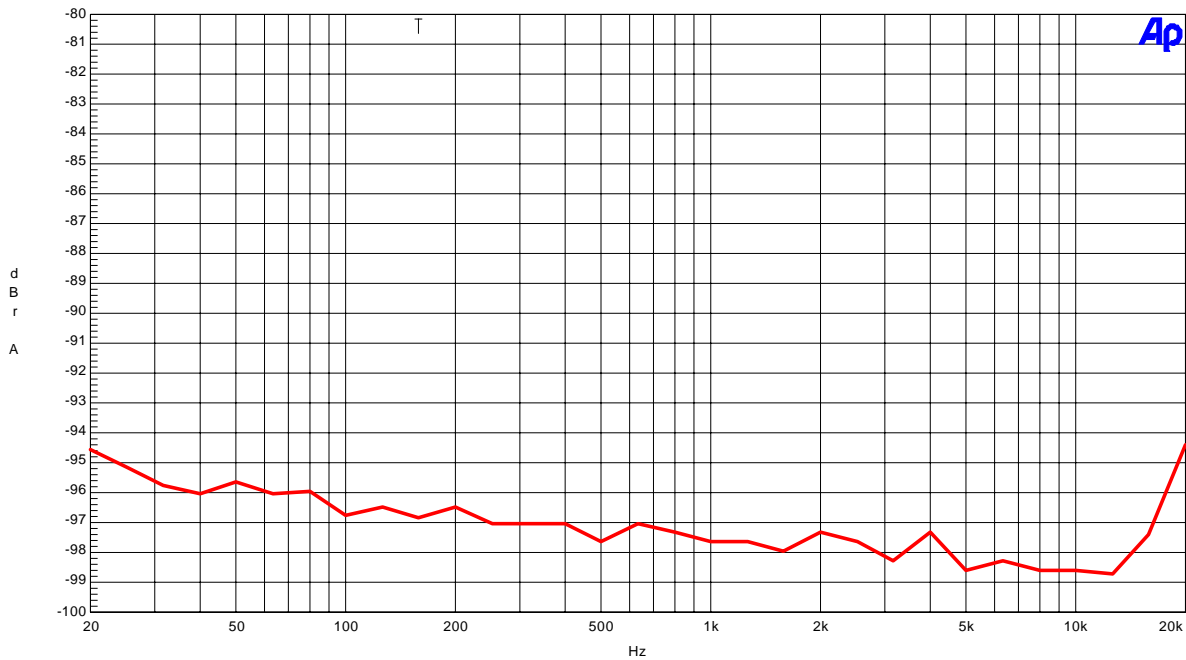

Figure 2-1-2. THD+N vs. Input frequency

AKM

AK4353 Linearity (AVDD=DVDD=5V, fs=44.1kHz, fin=1kHz)

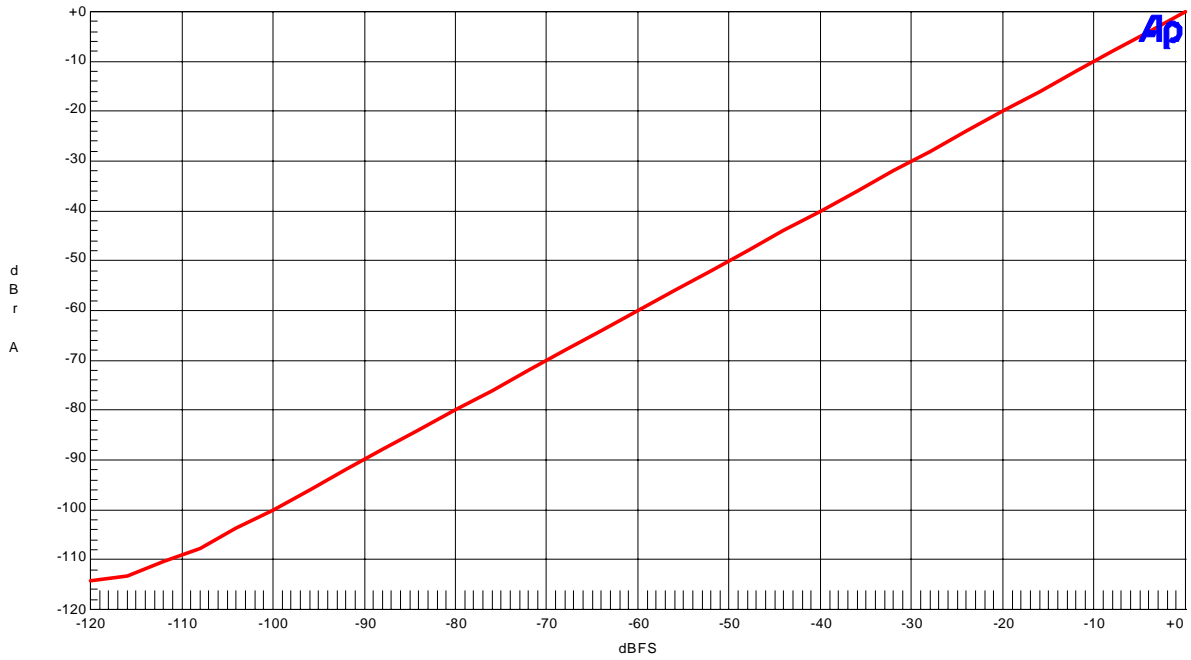

Figure 2-1-3. Linearity

AKM

AK4353 Frequency Response (AVDD=DVDD=5V, fs=44.1kHz, Input Level=0dBFS)

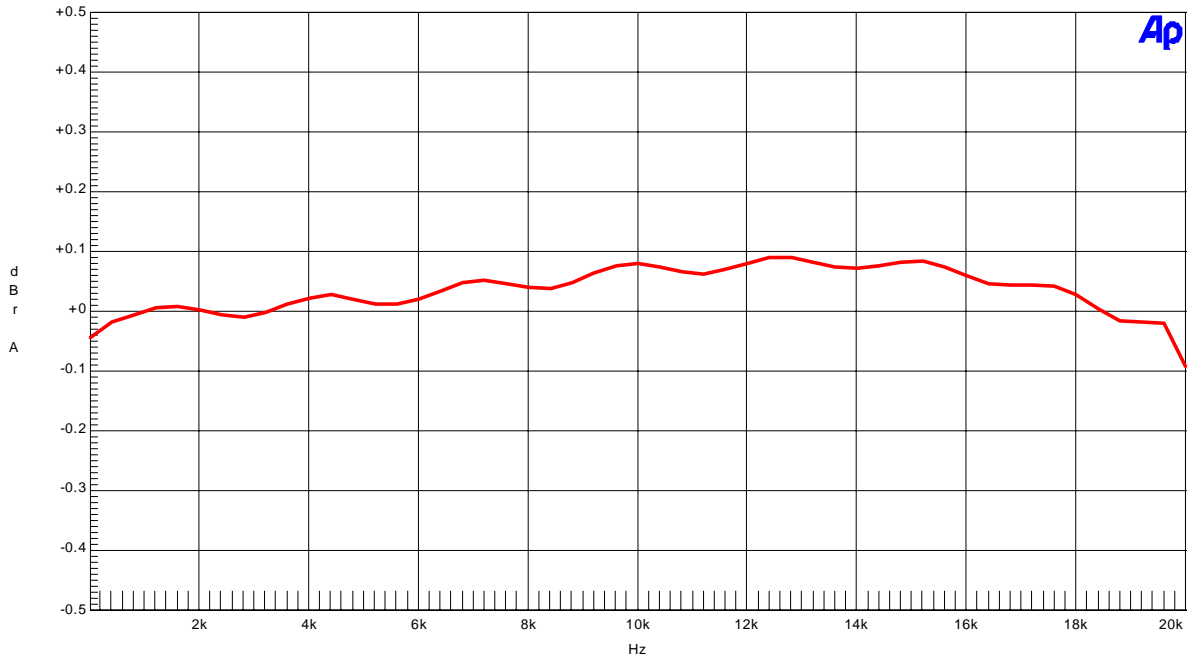

Figure 2-1-4. Frequency response

AKM

AK4353 Cross-talk (AVDD=DVDD=5V, fs=44.1kHz, Input Level=0dBFS)

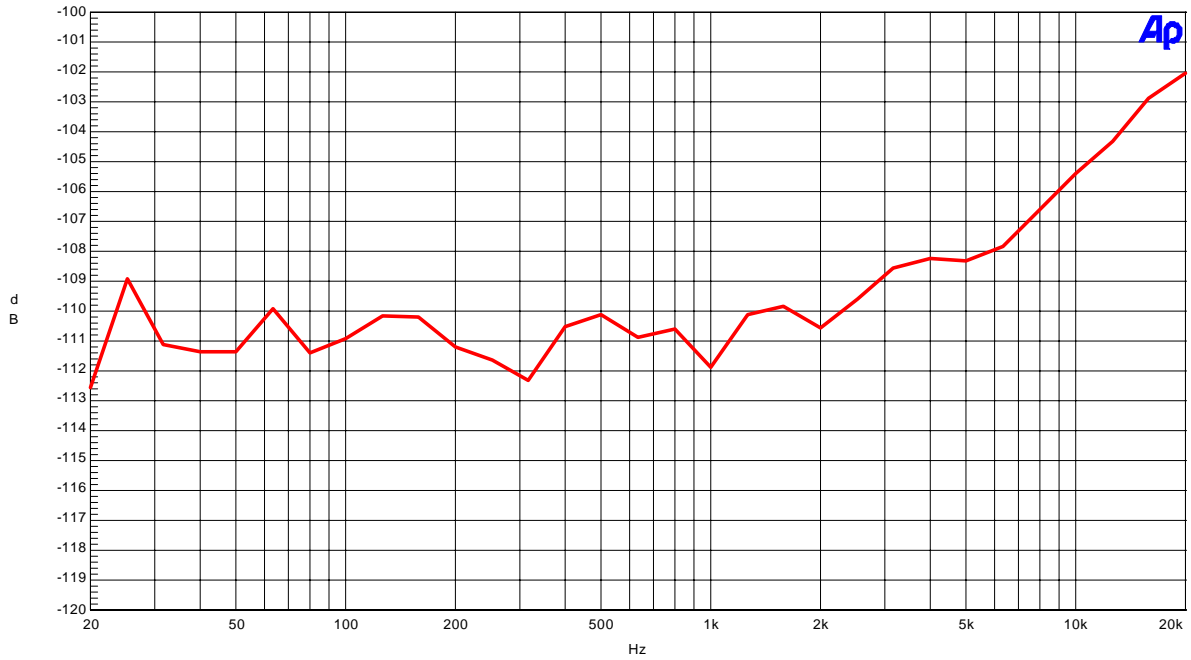

Figure 2-1-5. Cross-talk

AKM

AK4353 FFT (AVDD=DVDD=5V, fs=44.1kHz, fin=1kHz, Input Level=0dBFS)
FFT points=16384, Avg=8, Window=Eqirriple

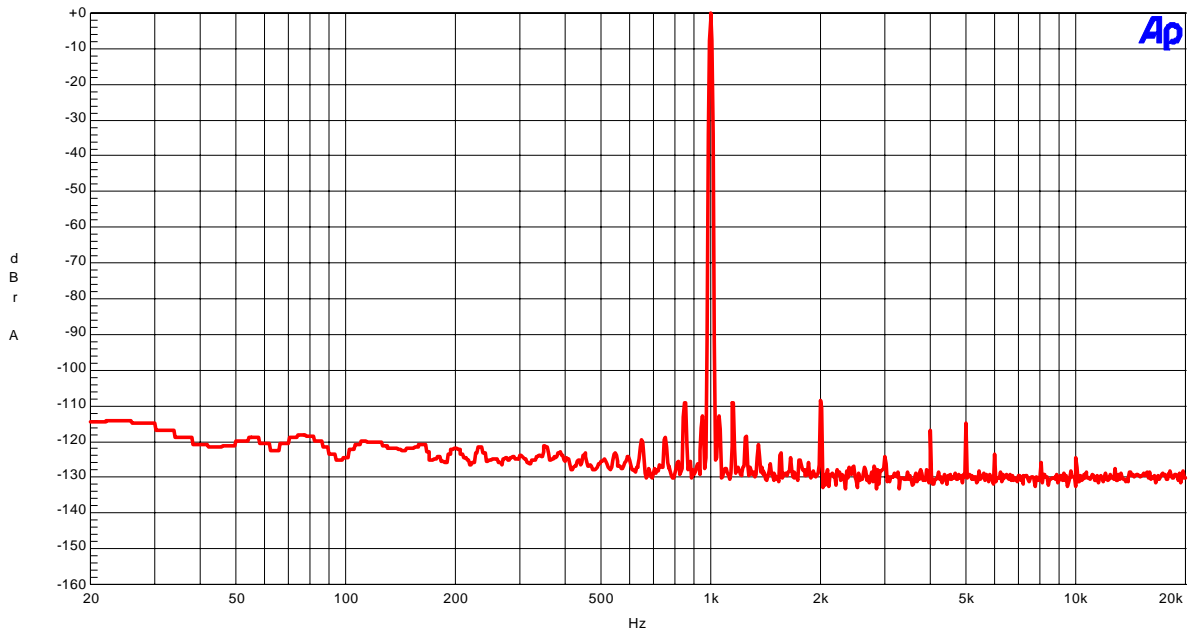

Figure 1-6. FFT (1kHz, 0dBFS)

AKM

AK4353 FFT (AVDD=DVDD=5V, fs=44.1kHz, fin=1kHz, Input Level=-60dBFS)
FFT points=16384, Avg=8, Window=Equiripple

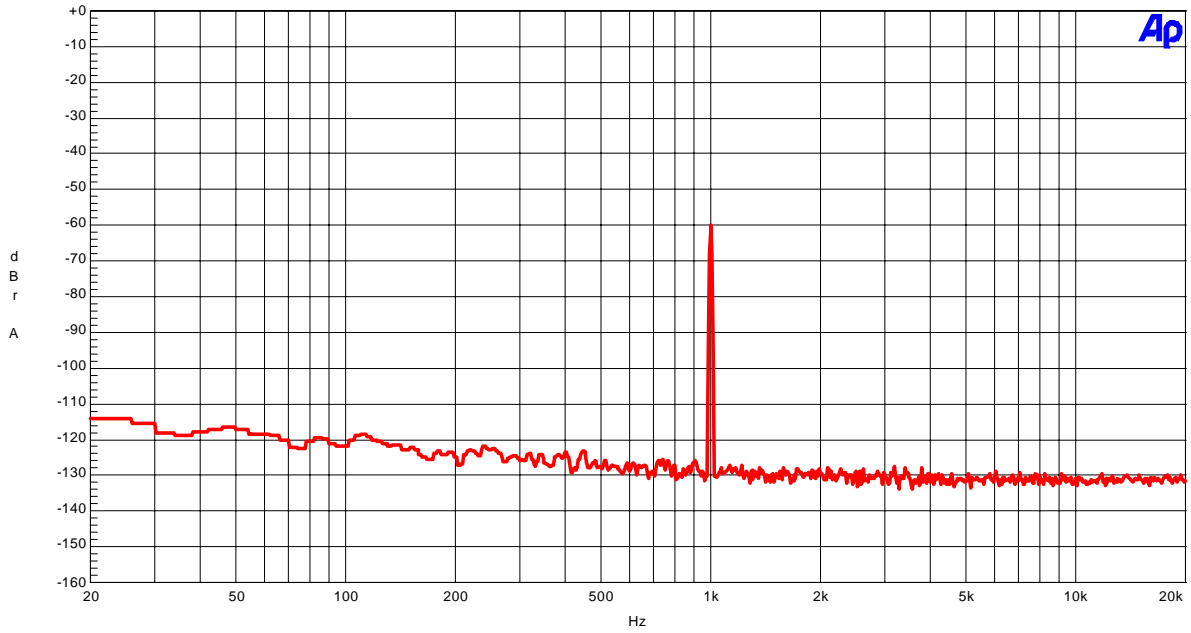

Figure 2-1-7. FFT (1kHz, -60dBFS)

AKM

AK4353 FFT (AVDD=DVDD=5V, fs=44.1kHz, No signal input)
FFT points=16384, Avg=8, Window=Equiripple

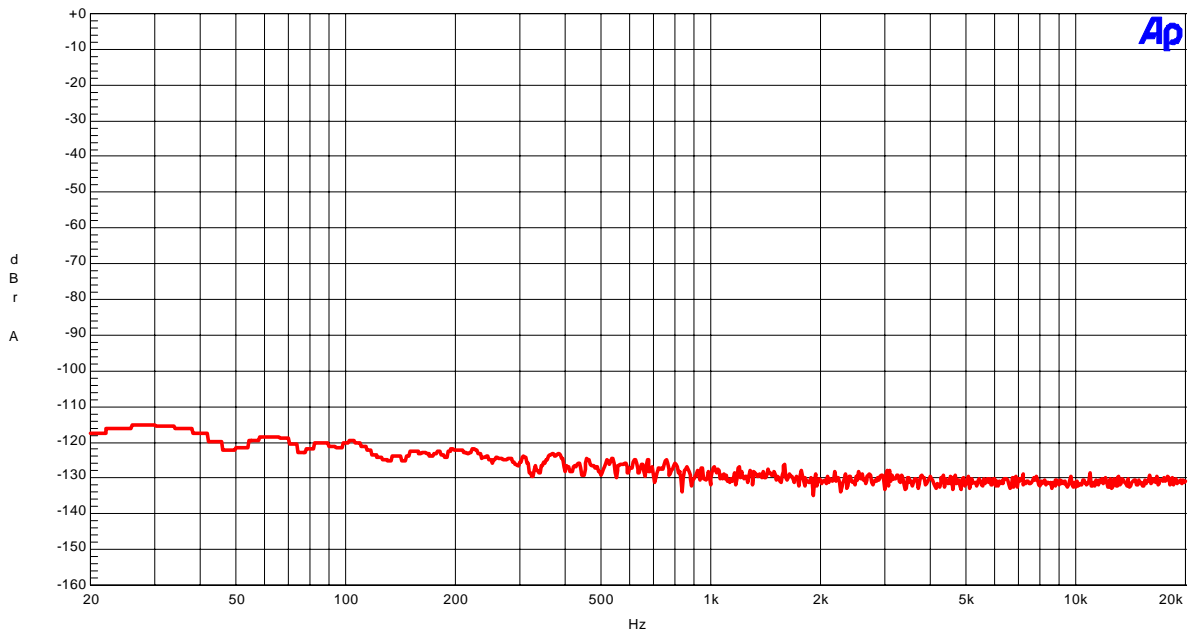

Figure 2-1-8. FFT (noise floor)

AKM

AK4353 FFT (Outband noise ~130kHz; AVDD=DVDD=5V, fs=44.1kHz, No signal input)
FFT points=16384, Avg=8, Window=Eqirriple

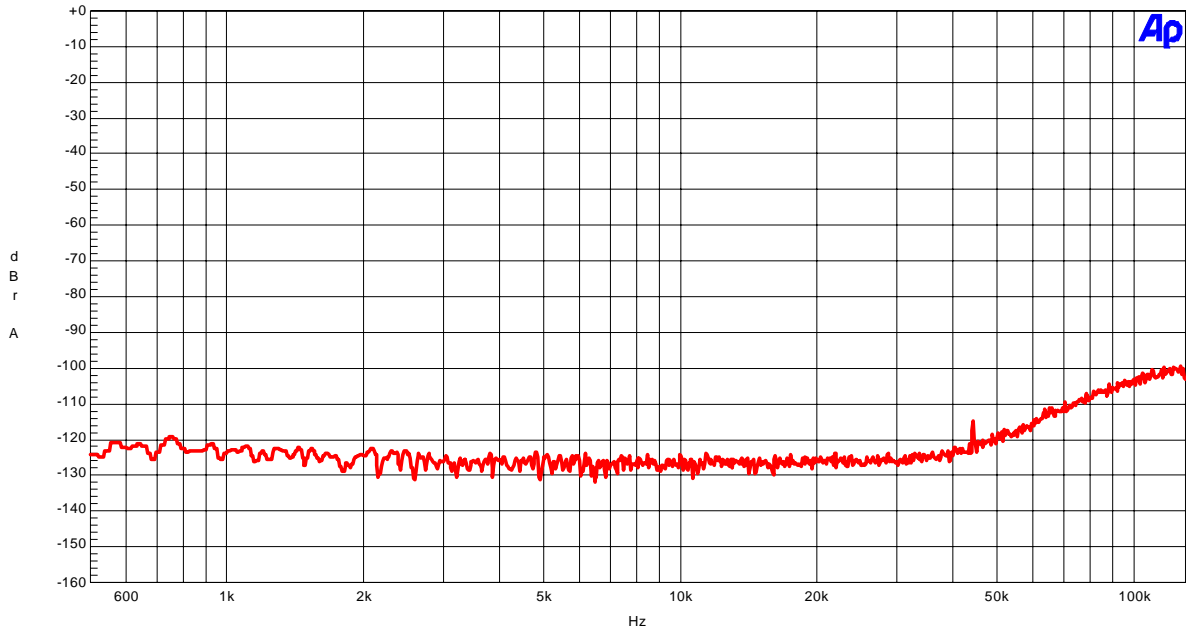

Figure 2-1-9. FFT (out-of-band noise)

2-2. fs=96kHz

AKM

AK4353 THD+N vs Input Level (AVDD=DVDD=5V, fs=96kHz, fin=1kHz)

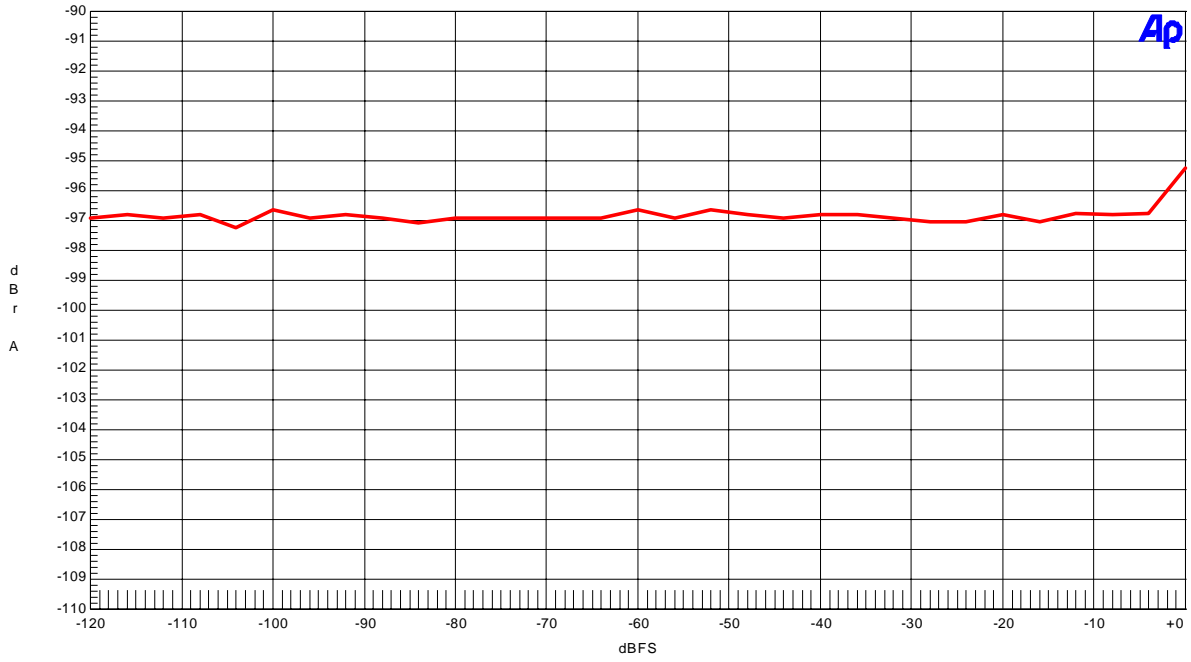

Figure 2-2-1. THD+N vs. Input level

AKM

AK4353 THD+N vs fin (AVDD=DVDD=5V, fs=96kHz, Input Level=0dBFS)

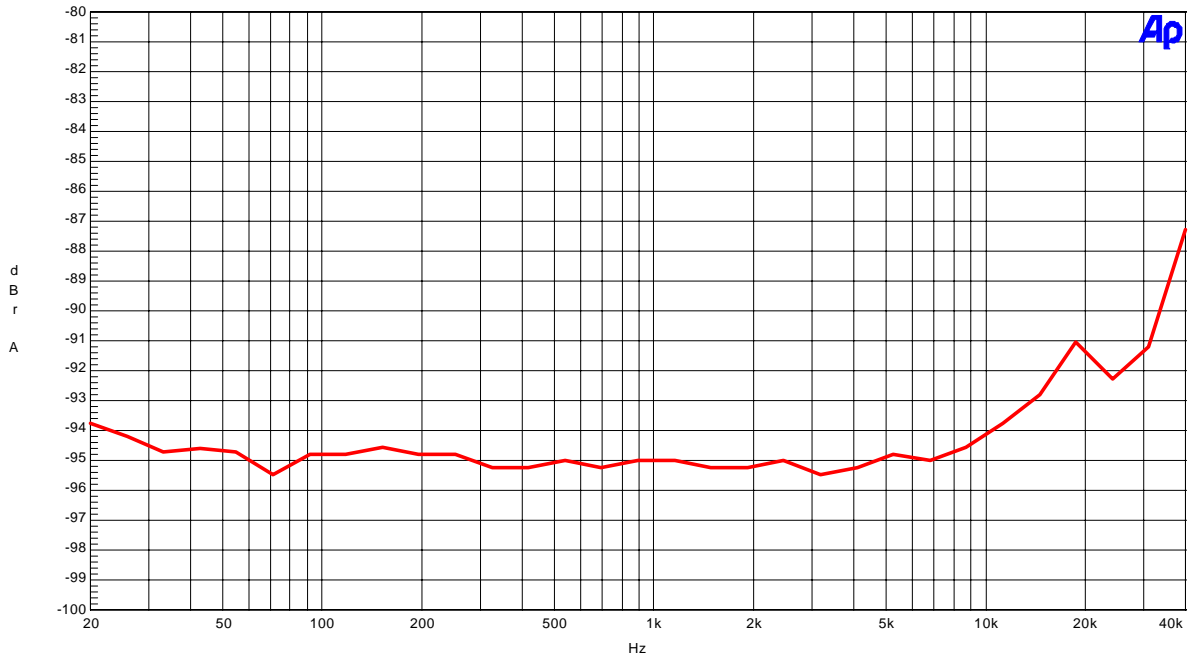

Figure 3-2-2. THD+N vs. Input frequency

AKM

AK4353 Linearity (AVDD=DVDD=5V, fs=96kHz, fin=1kHz)

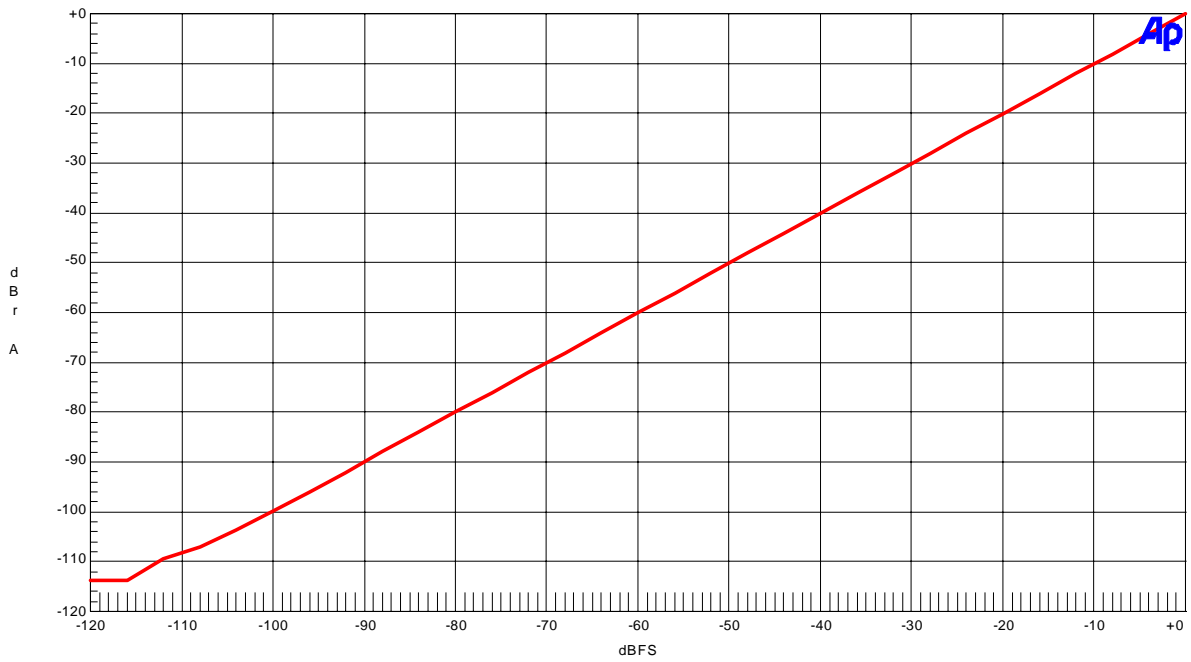

Figure 2-2-3. Linearity

AKM

AK4353 Frequency Response (AVDD=DVDD=5V, fs=96kHz, Input Level=0dBFS)

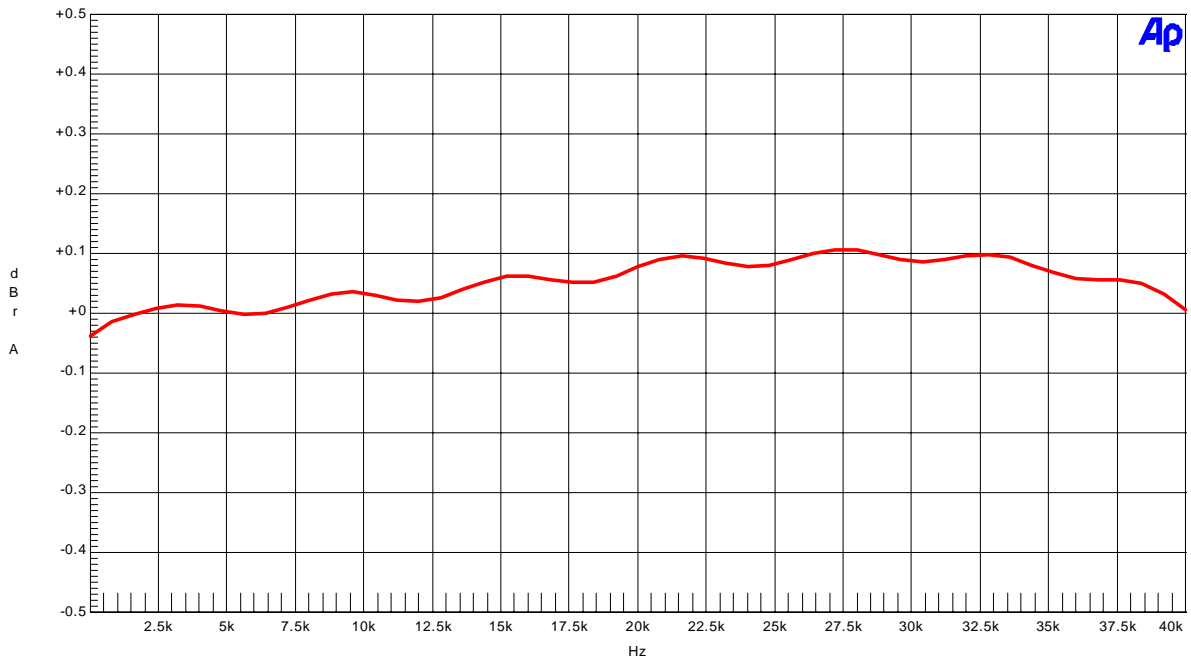
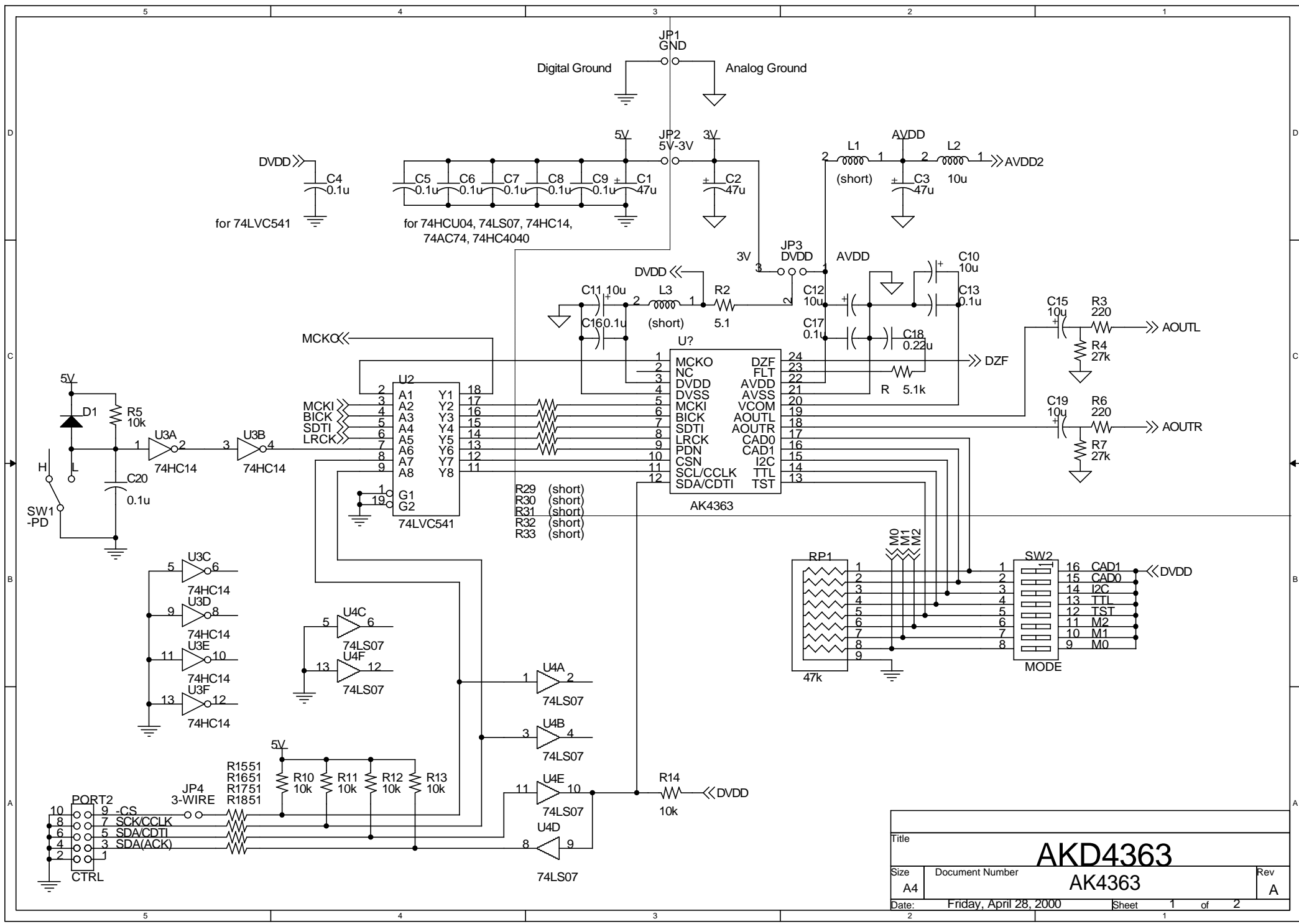
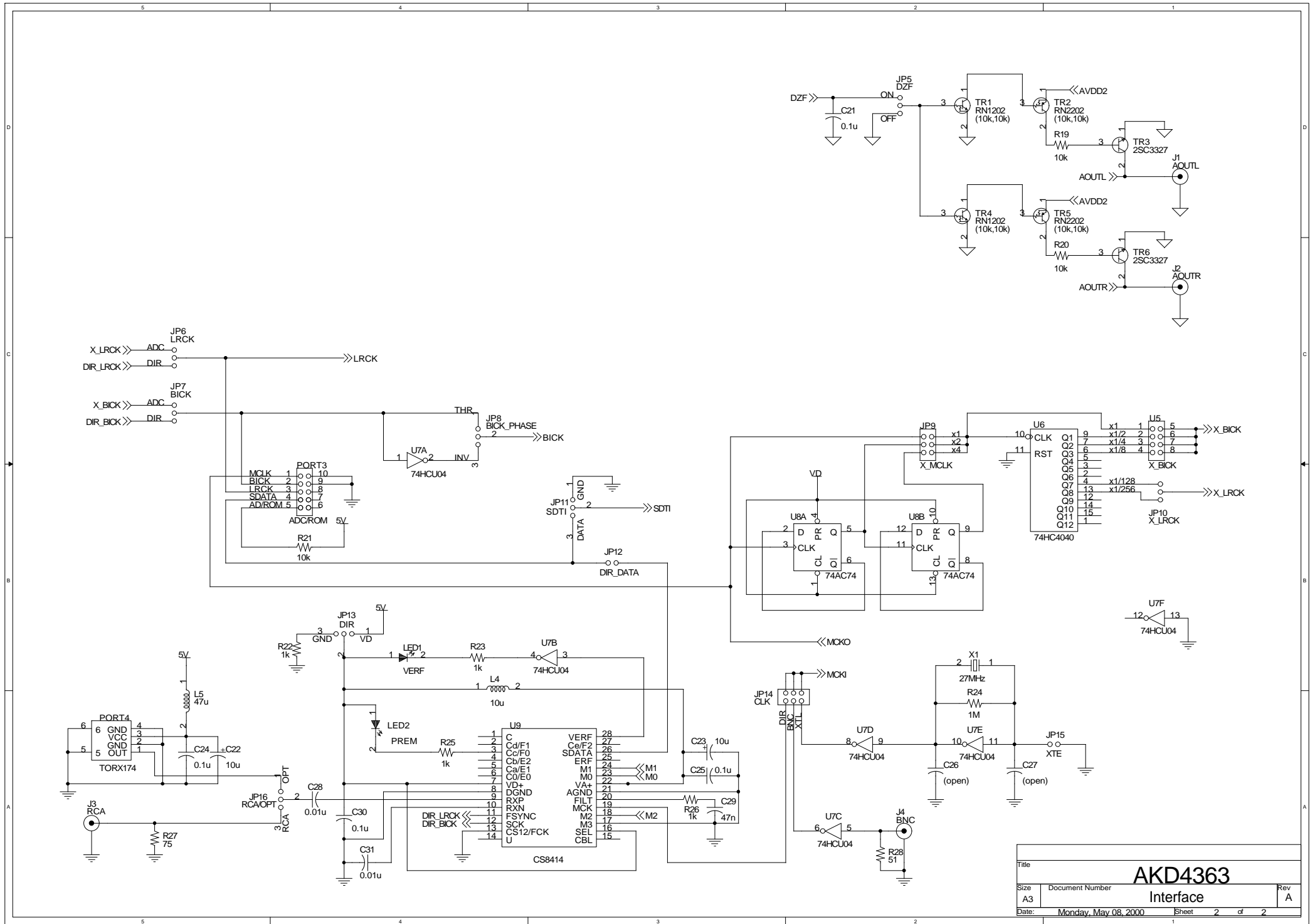

Figure 2-2-4. Frequency response



Title			AKD4363		
Size	Document Number		AK4363		Rev
A4					A
Date:	Friday, April 28, 2000		Sheet	1	of 2



Title		
AKD4363		
Size	Document Number	Rev
A3	Interface	A
Date:	Monday, May 08, 2000	Sheet 2 of 2

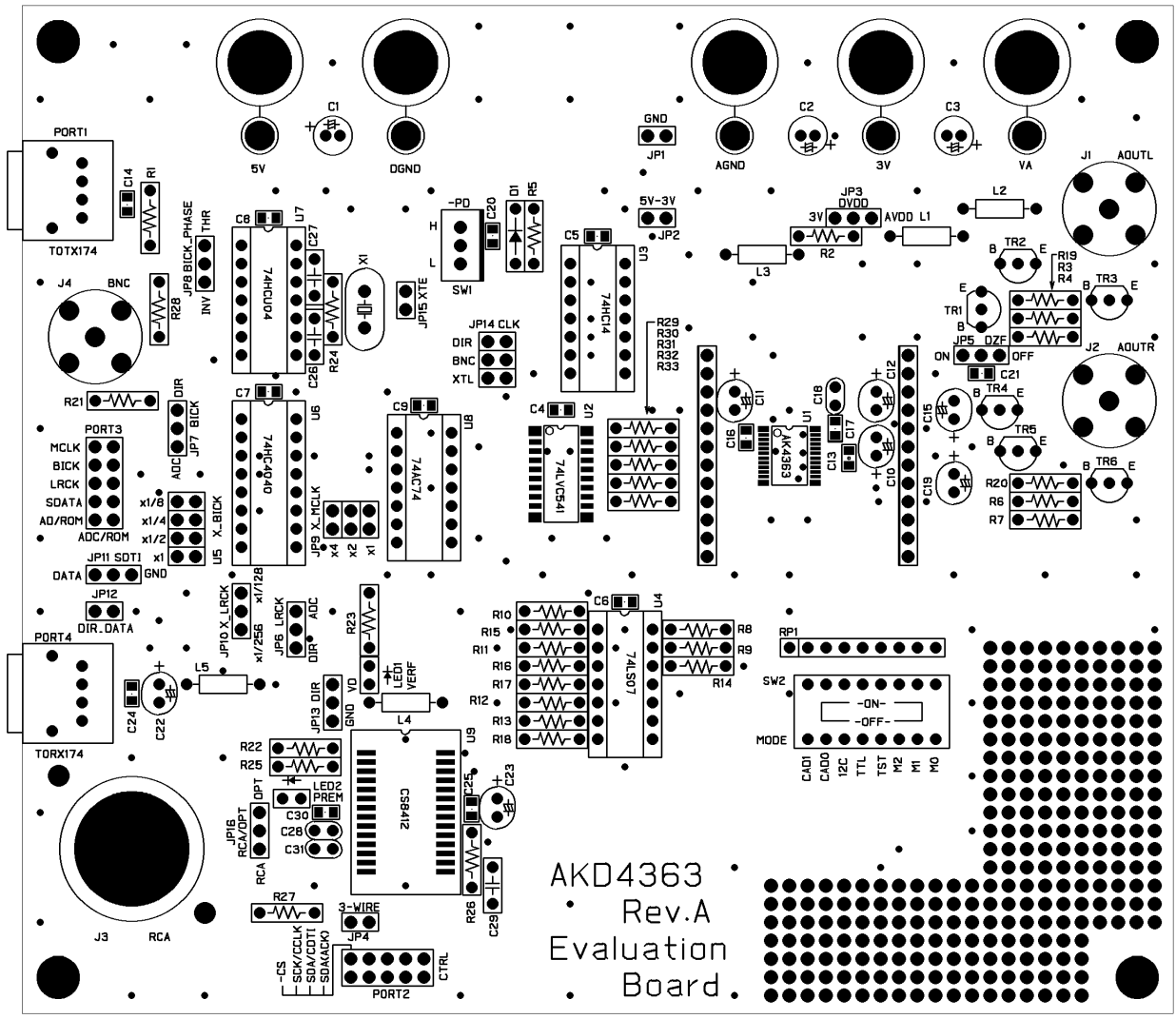

L1 レジスタシルク AKD4363 Rev.A

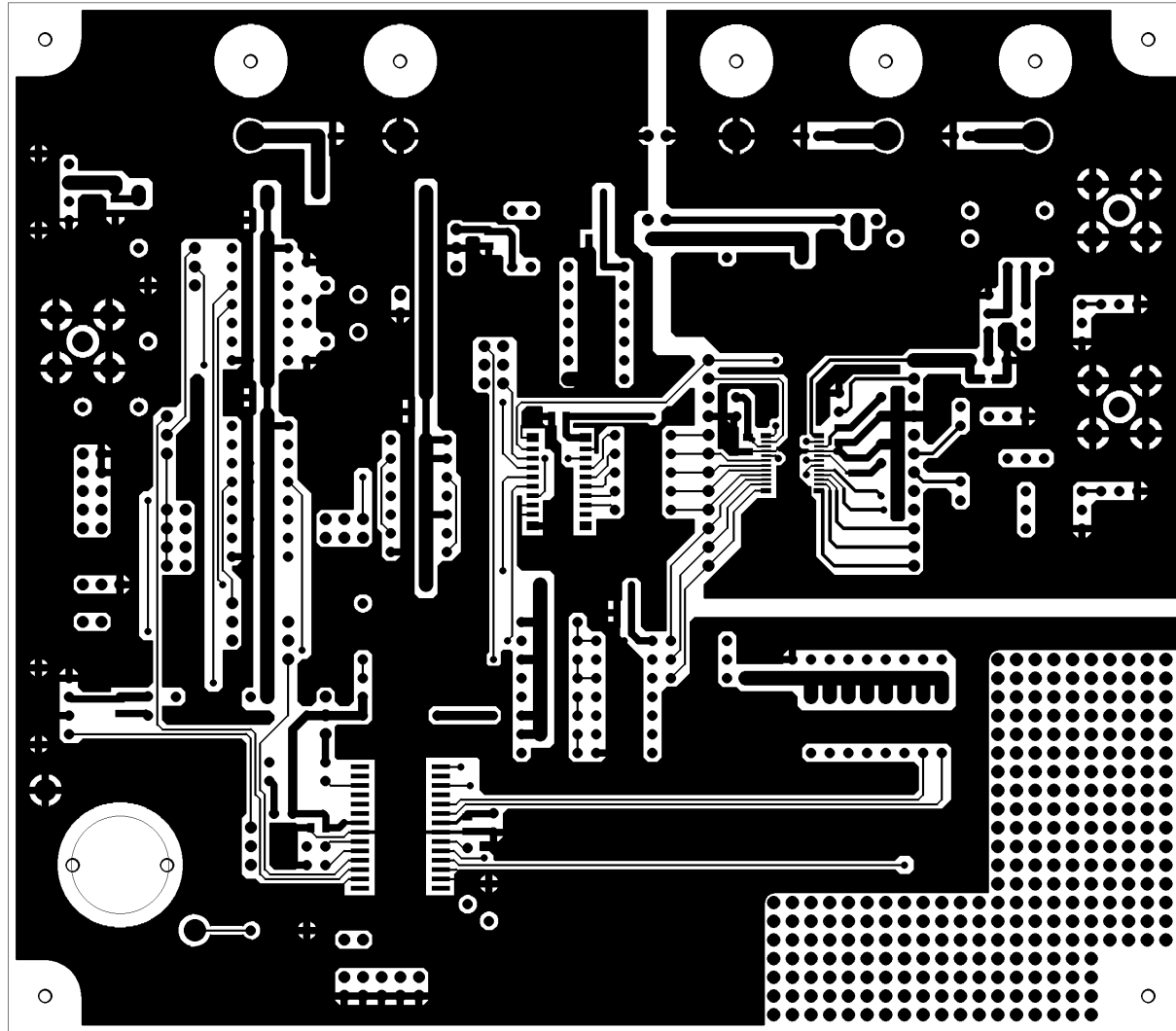

L1 部品面

AKD4363 Rev.A

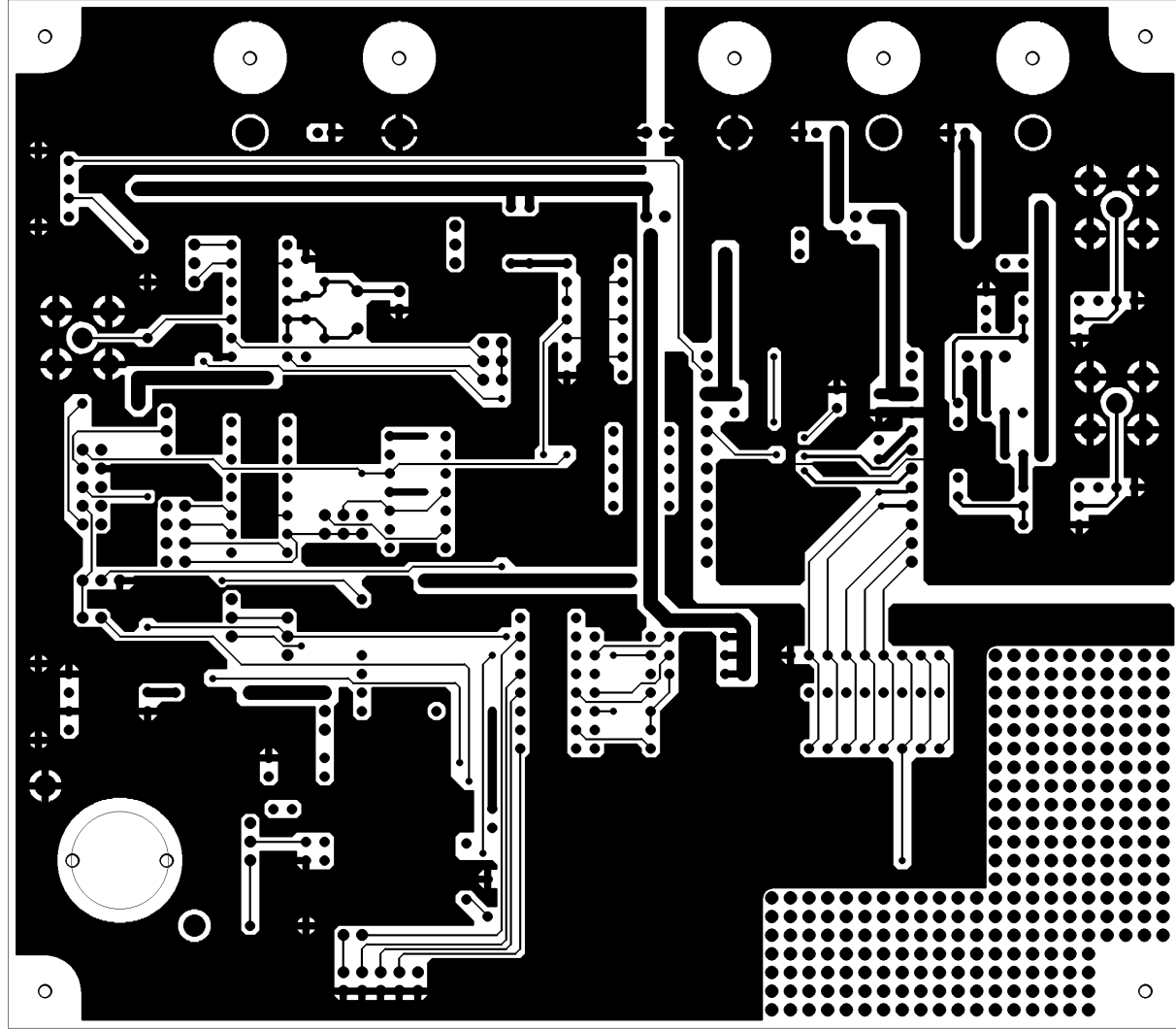

LS 半面 AKD4383 Rev.A

IMPORTANT NOTICE

- These products and their specifications are subject to change without notice. Before considering any use or application, consult the Asahi Kasei Microsystems Co., Ltd. (AKM) sales office or authorized distributor concerning their current status.
- AKM assumes no liability for infringement of any patent, intellectual property, or other right in the application or use of any information contained herein.
- Any export of these products, or devices or systems containing them, may require an export license or other official approval under the law and regulations of the country of export pertaining to customs and tariffs, currency exchange, or strategic materials.
- AKM products are neither intended nor authorized for use as critical components in any safety, life support, or other hazard related device or system, and AKM assumes no responsibility relating to any such use, except with the express written consent of the Representative Director of AKM. As used here:
 - (a) A hazard related device or system is one designed or intended for life support or maintenance of safety or for applications in medicine, aerospace, nuclear energy, or other fields, in which its failure to function or perform may reasonably be expected to result in loss of life or in significant injury or damage to person or property.
 - (b) A critical component is one whose failure to function or perform may reasonably be expected to result, whether directly or indirectly, in the loss of the safety or effectiveness of the device or system containing it, and which must therefore meet very high standards of performance and reliability.
- It is the responsibility of the buyer or distributor of an AKM product who distributes, disposes of, or otherwise places the product with a third party to notify that party in advance of the above content and conditions, and the buyer or distributor agrees to assume any and all responsibility and liability for and hold AKM harmless from any and all claims arising from the use of said product in the absence of such notification.