

International IOR Rectifier

30ETH06PbF

Hyperfast Rectifier

Features

- Hyperfast Recovery Time
- Low Forward Voltage Drop
- Low Leakage Current
- 175°C Operating Junction Temperature
- Dual Diode Center Tap
- Lead-Free ("PbF" suffix)

$t_{rr} = 28\text{ns typ.}$
 $I_{F(AV)} = 30\text{Amp}$
 $V_R = 600\text{V}$

Description/ Applications

State of the art Hyperfast recovery rectifiers designed with optimized performance of forward voltage drop, Hyperfast recover time, and soft recovery.

The planar structure and the platinum doped life time control guarantee the best overall performance, ruggedness and reliability characteristics.

These devices are intended for use in PFC Boost stage in the AC-DC section of SMPS, inverters or as freewheeling diodes.

The IR extremely optimized stored charge and low recovery current minimize the switching losses and reduce over dissipation in the switching element and snubbers.

Absolute Maximum Ratings

Parameters	Max	Units
V_{RRM} Peak Repetitive Reverse Voltage	600	V
$I_{F(AV)}$ Average Rectifier Forward Current @ $T_C = 103^\circ\text{C}$	30	A
I_{FSM} Non Repetitive Peak Surge Current @ $T_J = 25^\circ\text{C}$	200	
T_J, T_{STG} Operating Junction and Storage Temperatures	- 65 to 175	$^\circ\text{C}$

Case Styles

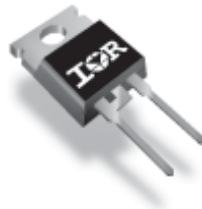

TO-220AC

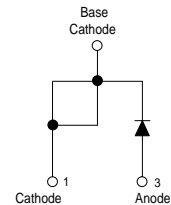

Electrical Characteristics @ T_J = 25°C (unless otherwise specified)

Parameters	Min	Typ	Max	Units	Test Conditions
V _{BR} , V _F Breakdown Voltage, Blocking Voltage	600	-	-	V	I _R = 100μA
V _F Forward Voltage	-	2.0	2.6	V	I _F = 30A, T _J = 25°C
	-	1.34	1.75	V	I _F = 30A, T _J = 150°C
I _R Reverse Leakage Current	-	0.3	50	μA	V _R = V _R Rated
	-	60	500	μA	T _J = 150°C, V _R = V _R Rated
C _T Junction Capacitance	-	33	-	pF	V _R = 600V
L _S Series Inductance	-	8.0	-	nH	Meas. lead to lead 5mm from package body

Dynamic Recovery Characteristics @ T_J = 25°C (unless otherwise specified)

Parameters	Min	Typ	Max	Units	Test Conditions
t _{rr} Reverse Recovery Time	-	28	35	ns	I _F = 1.0A, di _F /dt = 50A/μs, V _R = 30V
	-	31	-		T _J = 25°C
	-	77	-		T _J = 125°C
I _R RRM Peak Recovery Current	-	3.5	-	A	T _J = 25°C
	-	7.7	-		T _J = 125°C
Q _{rr} Reverse Recovery Charge	-	65	-	nC	T _J = 25°C
	-	345	-		T _J = 125°C

I_F = 30A
V_R = 200V
di_F/dt = 200A/μs

Thermal - Mechanical Characteristics

Parameters	Min	Typ	Max	Units
T _J Max. Junction Temperature Range	- 65	-	175	°C
T _{Stg} Max. Storage Temperature Range	- 65	-	175	
R _{thJC} Thermal Resistance, Junction to Case Per Leg	-	0.7	1.1	°C/W
R _{thJA} ^① Thermal Resistance, Junction to Ambient Per Leg	-	-	70	
R _{thCS} ^② Thermal Resistance, Case to Heatsink	-	0.2	-	
Wt Weight	-	2.0	-	g
	-	0.07	-	(oz)
Mounting Torque	6.0	-	12	Kg-cm
	5.0	-	10	lbf.in
Case Style	TO-220AC			JEDEC
Marking Device	30ETH06			

① Typical Socket Mount

② Mounting Surface, Flat, Smooth and Greased

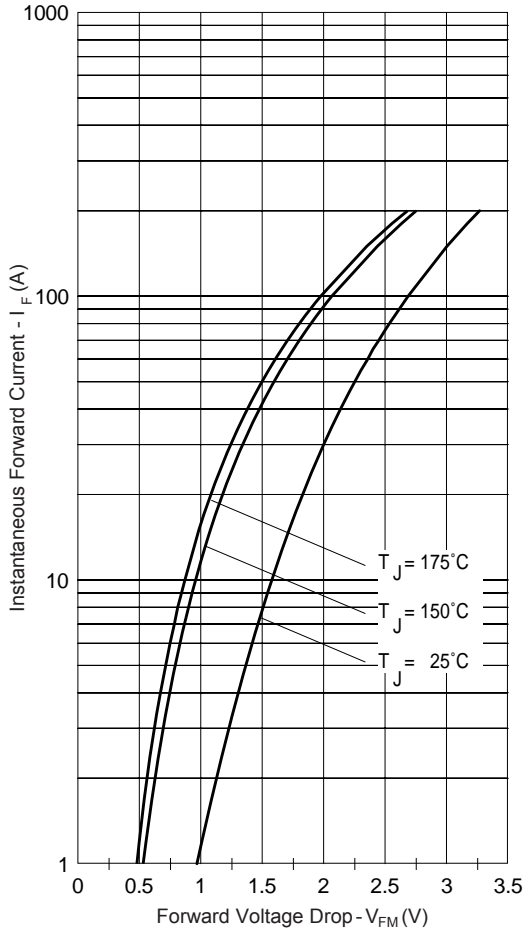

Fig. 1 - Typical Forward Voltage Drop Characteristics

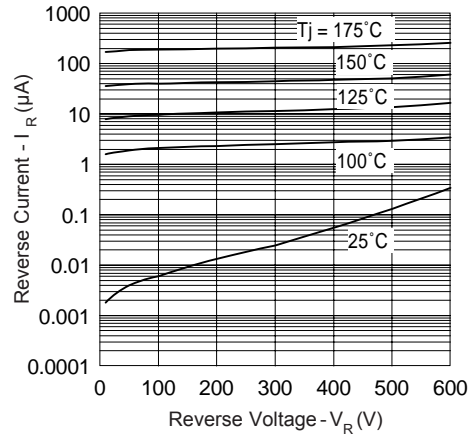

Fig. 2 - Typical Values Of Reverse Current Vs. Reverse Voltage

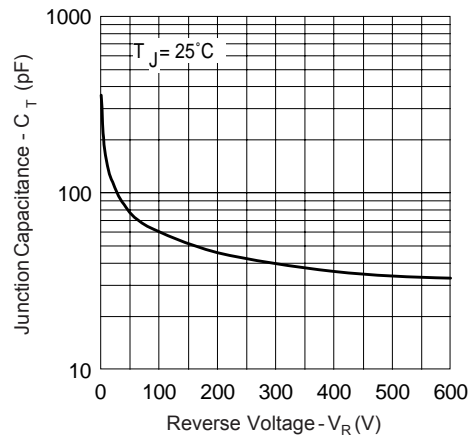

Fig. 3 - Typical Junction Capacitance Vs. Reverse Voltage

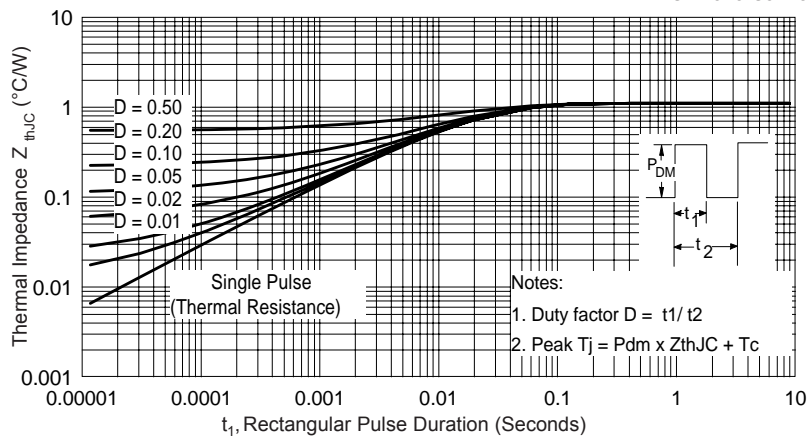

Fig. 4 - Max. Thermal Impedance Z_{thJC} Characteristics

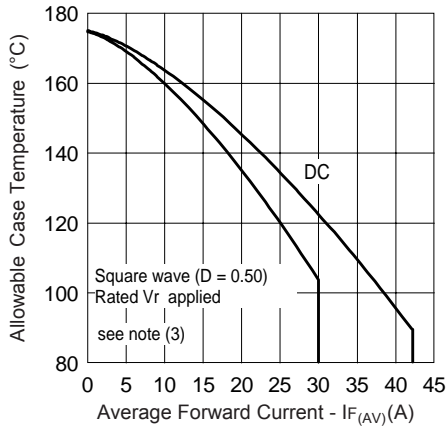

Fig. 5 - Max. Allowable Case Temperature Vs. Average Forward Current

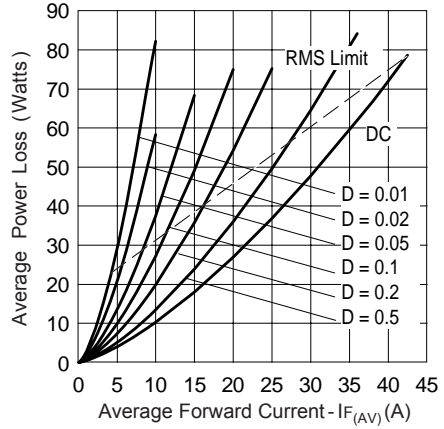

Fig. 6 - Forward Power Loss Characteristics

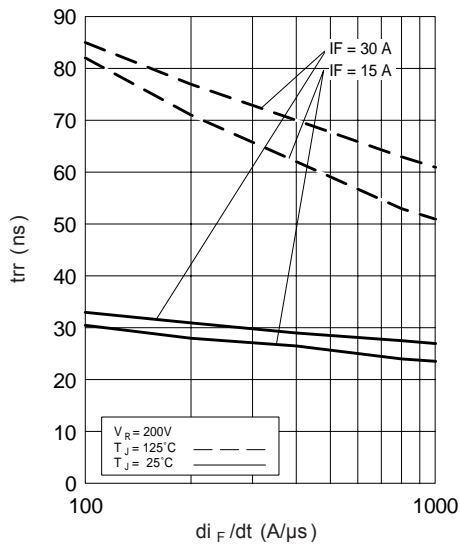

Fig. 7 - Typical Reverse Recovery vs. di_F/dt

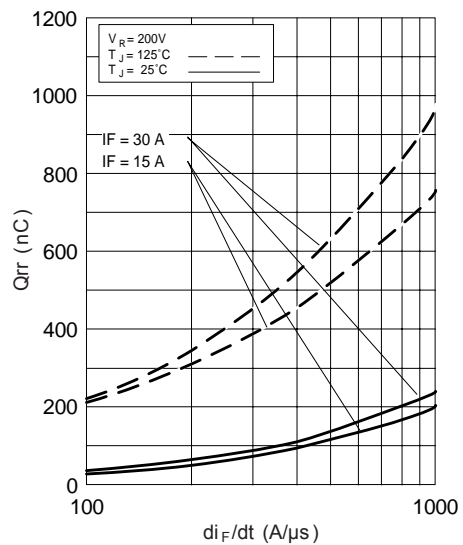

Fig. 8 - Typical Stored Charge vs. di_F/dt

- (3) Formula used: $T_C = T_J - (Pd + Pd_{REV}) \times R_{thJC}$;
 $Pd = \text{Forward Power Loss} = I_{F(AV)} \times V_{FM} @ (I_{F(AV)} / D)$ (see Fig. 6);
 $Pd_{REV} = \text{Inverse Power Loss} = V_{R1} \times I_{R1} (1 - D)$; $I_{R1} @ V_{R1} = \text{rated } V_R$

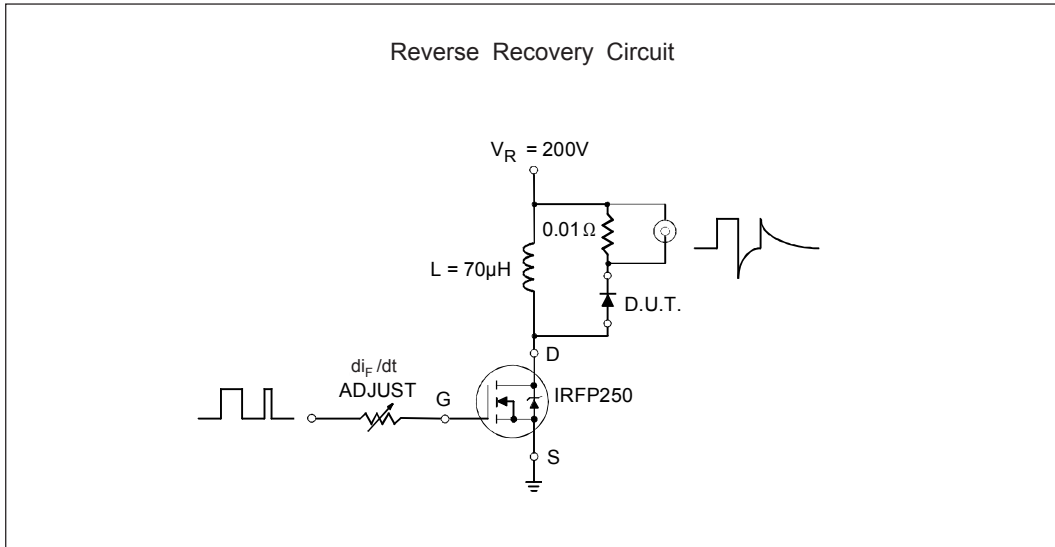

Fig. 9- Reverse Recovery Parameter Test Circuit

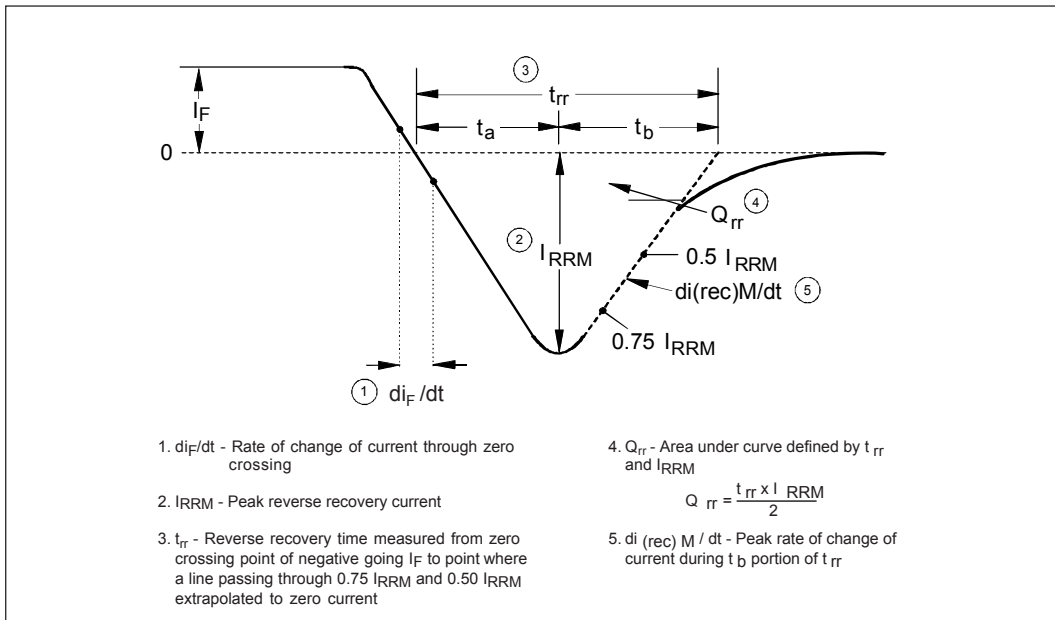
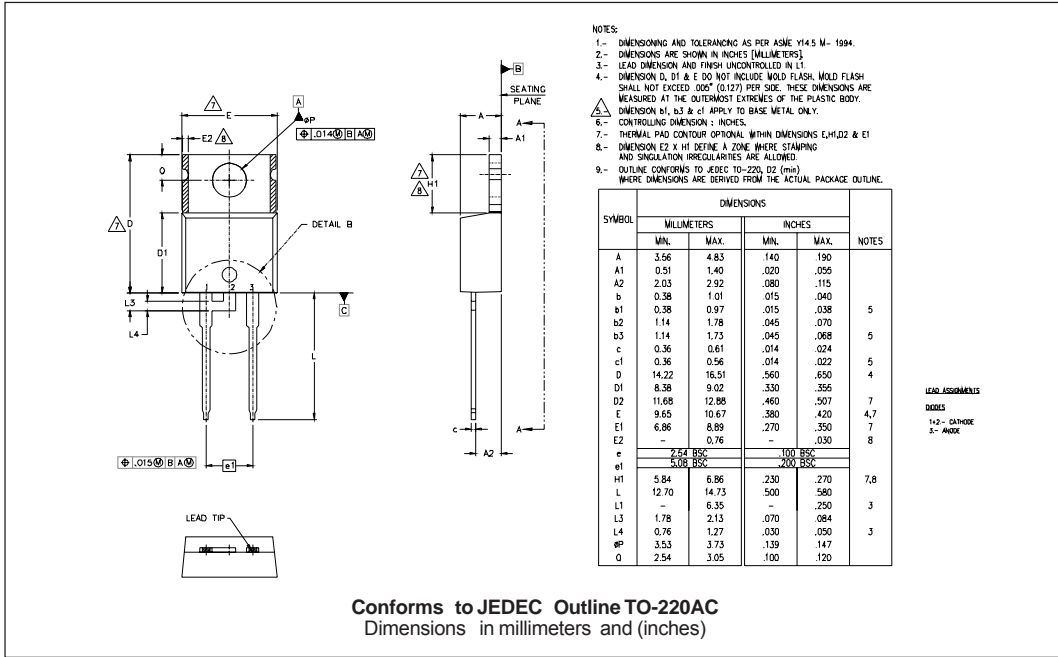
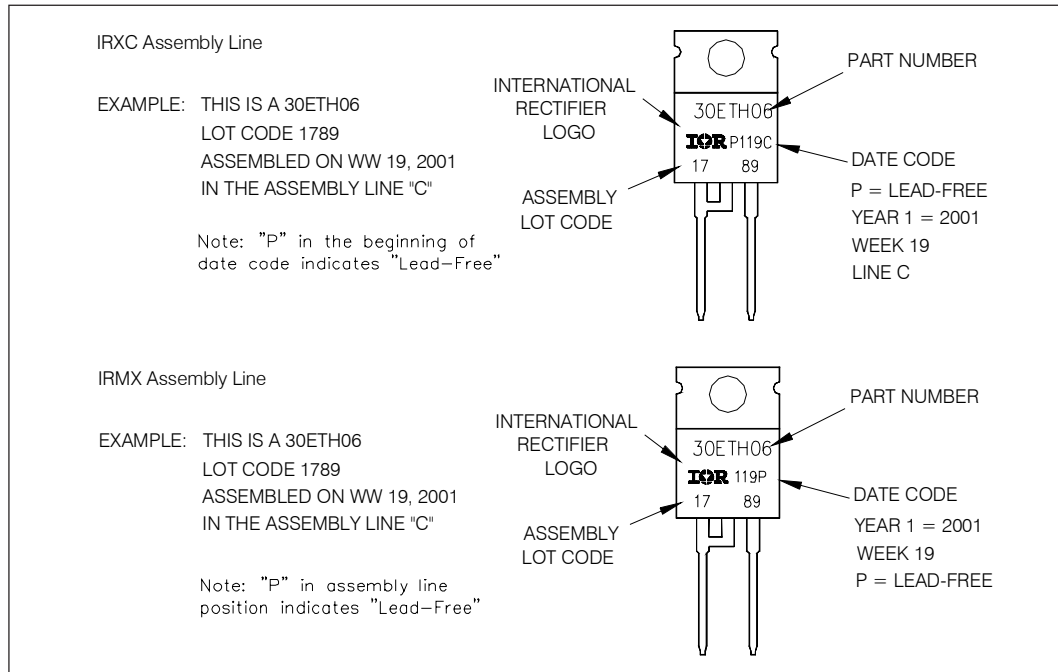

Fig. 10 - Reverse Recovery Waveform and Definitions

Outline Table



Part Marking Information



Ordering Information Table

Device Code																									
	<table border="1" style="display: inline-table; border-collapse: collapse;"> <tr> <td style="padding: 5px;">30</td> <td style="padding: 5px;">E</td> <td style="padding: 5px;">T</td> <td style="padding: 5px;">H</td> <td style="padding: 5px;">06</td> <td style="padding: 5px;">PbF</td> </tr> </table>	30	E	T	H	06	PbF																		
30	E	T	H	06	PbF																				
	<table style="display: inline-table; border: none;"> <tr> <td style="text-align: center; padding: 0 5px;">①</td> <td style="text-align: center; padding: 0 5px;">②</td> <td style="text-align: center; padding: 0 5px;">③</td> <td style="text-align: center; padding: 0 5px;">④</td> <td style="text-align: center; padding: 0 5px;">⑤</td> <td style="text-align: center; padding: 0 5px;">⑥</td> </tr> </table>	①	②	③	④	⑤	⑥																		
①	②	③	④	⑤	⑥																				
<table style="border: none;"> <tr><td style="background-color: black; color: white; padding: 2px 5px;">1</td><td style="padding: 2px 5px;">-</td><td style="padding: 2px 5px;">Current Rating (30 = 30A)</td></tr> <tr><td style="background-color: black; color: white; padding: 2px 5px;">2</td><td style="padding: 2px 5px;">-</td><td style="padding: 2px 5px;">E = Single Diode</td></tr> <tr><td style="background-color: black; color: white; padding: 2px 5px;">3</td><td style="padding: 2px 5px;">-</td><td style="padding: 2px 5px;">Package</td></tr> <tr><td></td><td style="padding: 2px 5px;"></td><td style="padding: 2px 5px;">T = TO-220</td></tr> <tr><td style="background-color: black; color: white; padding: 2px 5px;">4</td><td style="padding: 2px 5px;">-</td><td style="padding: 2px 5px;">H = HyperFast Recovery</td></tr> <tr><td style="background-color: black; color: white; padding: 2px 5px;">5</td><td style="padding: 2px 5px;">-</td><td style="padding: 2px 5px;">Voltage Rating (06 = 600V)</td></tr> <tr><td style="background-color: black; color: white; padding: 2px 5px;">6</td><td style="padding: 2px 5px;">-</td><td style="padding: 2px 5px;">• none = Standard Production</td></tr> <tr><td></td><td style="padding: 2px 5px;"></td><td style="padding: 2px 5px;">• PbF = Lead-Free</td></tr> </table>	1	-	Current Rating (30 = 30A)	2	-	E = Single Diode	3	-	Package			T = TO-220	4	-	H = HyperFast Recovery	5	-	Voltage Rating (06 = 600V)	6	-	• none = Standard Production			• PbF = Lead-Free	
1	-	Current Rating (30 = 30A)																							
2	-	E = Single Diode																							
3	-	Package																							
		T = TO-220																							
4	-	H = HyperFast Recovery																							
5	-	Voltage Rating (06 = 600V)																							
6	-	• none = Standard Production																							
		• PbF = Lead-Free																							
	Tube Standard Pack Quantity : 50 pieces																								

Data and specifications subject to change without notice.
 This product has been designed and qualified for Industrial Level and Lead-Free.
 Qualification Standards can be found on IR's Web site.