



# 300mA CMOS Dual LDO Regulator

## FEATURES

- Two outputs with guaranteed 300mA peak output current
- Low dropout voltages of 210mV typical at 300mA
- Stable with ceramic output capacitors
- Independent enable pins
- Under voltage lockout
- No-load ground current of 100µA typical
- Full-load ground current of 160µA typical
- ±1.0% output voltage initial accuracy
- ±2.0% accuracy over temperature
- “Zero” current shutdown mode
- Fold-back current limit and thermal protection
- TSOT-23 6-lead, 0.8mm height package

## APPLICATIONS

- Cellular phones
- Battery-powered devices
- Consumer Electronics

## DESCRIPTION

The 300mA CMOS Dual LDO CAT6221 combines in a single TSOT-23 6-lead package two low dropout regulators (LDO), each with its own enable pin.

The regulator outputs drive loads up to 300mA. By design, the dual LDO provides fast response time during load current and line voltage changes.

Each LDO is optimized for low noise and high crosstalk isolation. With zero shut down current and a low quiescent current of 100µA, the dual LDO is ideal for battery-operated devices with supply voltage from 2.3V to 5.5V.

The dual LDO offers 1% initial accuracy and very low dropout voltage, typical 210mV at 300mA. Stable operation is provided with small 1µF ceramic output capacitors, reducing required board space and component cost.

Other features include fold-back current limit and thermal protection.

The dual LDO is available in the tiny 6-lead TSOT-23 package with a maximum height of 0.8mm.

For Ordering Information details, see page 10.

## PIN CONFIGURATION

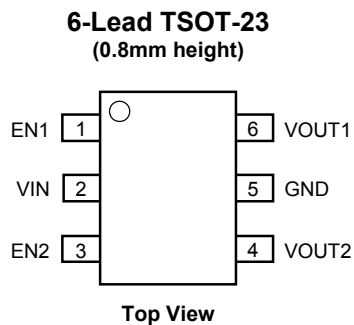

## TYPICAL APPLICATION CIRCUIT

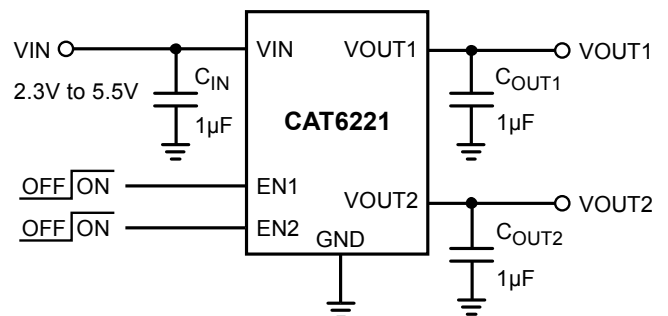

### PIN DESCRIPTIONS

Pin #	Name	Function
1	EN1	Enable input (active high) for VOUT1.
2	VIN	Supply voltage input.
3	EN2	Enable input (active high) for VOUT2.
4	VOUT2	LDO Output Voltage 2.
5	GND	Ground reference.
6	VOUT1	LDO Output Voltage 1.

### PIN FUNCTION

**VIN** is the supply pin for the LDO. A small 1μF ceramic bypass capacitor is required between the  $V_{IN}$  pin and ground near the device. When using longer connections to the power supply,  $C_{IN}$  value can be increased without limit. The operating input voltage range is from 2.3V to 5.5V.

**EN1 & 2** are the enable control logic (active high) for the regulator outputs.

**VOUT1 & 2** are the LDO regulator outputs. A small 1μF ceramic bypass capacitor is required between the VOUT pins and ground. For better transient response, its value can be increased to 4.7μF.

The capacitor should be located near the device. For the TSOT23 6-lead package, a continuous 300mA output current for both LDOs may turn-on the thermal protection.

### ABSOLUTE MAXIMUM RATINGS<sup>(1)</sup>

Parameter	Rating	Unit
$V_{IN}$	0 to 6.5	V
$V_{EN}, V_{OUT}$	-0.3 to $V_{IN}+0.3$	V
Junction Temperature, $T_J$	+150	°C
Power Dissipation, $P_D$	Internally Limited <sup>(2)</sup>	mW
Storage Temperature Range, $T_S$	-65 to +150	°C
Lead Temperature (soldering, 5 sec.)	260	°C
ESD Rating (Human Body Model)	3	kV

### RECOMMENDED OPERATING CONDITIONS<sup>(3)</sup>

Parameter	Range	Unit
$V_{IN}$	2.3 to 5.5	V
$V_{EN}$	0 to $V_{IN}$	V
Junction Temperature Range, $T_J$	-40 to +125	°C
Package Thermal Resistance (TSOT23), $\theta_{JA}$	235	°C/W

Typical application circuit with external components are shown on page 1.

**Notes:**

- (1) Exceeding maximum rating may damage the device.
- (2) The maximum allowable power dissipation at any  $T_A$  (ambient temperature) is  $P_{Dmax} = (T_{Jmax} - T_A) / \theta_{JA}$ . Exceeding the maximum allowable power dissipation will result in excessive die temperature, and the regulator will go into thermal shutdown.
- (3) The device is not guaranteed to work outside its operating rating.

### BLOCK DIAGRAM

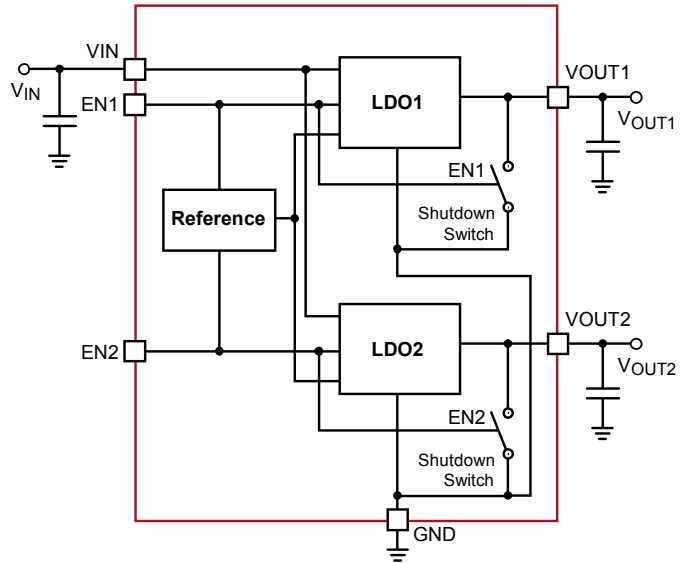

**Figure 2. CAT6221 Functional Block Diagram**

On each output, a 250Ω internal shutdown switch discharges the output capacitor in the no-load condition.

**GND** is the ground reference for the LDO. The pin must be connected to the ground plane on the PCB.

**ELECTRICAL OPERATING CHARACTERISTICS <sup>(1)</sup>**
 $V_{IN} = V_{OUT} + 1.0V$ ,  $V_{EN} = \text{High}$ ,  $I_{OUT} = 100\mu A$ ,  $C_{IN} = C_{OUT} = 1\mu F$ , ambient temperature of 25°C (over recommended operating conditions unless specified otherwise). **Bold numbers** apply for the entire junction temperature range.

Symbol	Parameter	Conditions	Min	Typ	Max	Unit
$V_{OUT-ACC}$	Output Voltage Accuracy	Initial accuracy	-1.0		+1.0	%
			<b>-2.0</b>		<b>+2.0</b>	
$TC_{OUT}$	Output Voltage Temp. Coefficient			40		ppm/°C
$V_{R-LINE}$	Line Regulation	$V_{IN} = V_{OUT} + 1.0V$ to 5.5V	-0.2	$\pm 0.1$	+0.2	%/V
			<b>-0.4</b>		<b>+0.4</b>	
$V_{R-LOAD}$	Load Regulation	$I_{OUT} = 100\mu A$ to 300 mA		0.9	1.5	%
					<b>2</b>	
$V_{DROP}$	Dropout Voltage <sup>(2)</sup>	$I_{OUT} = 300mA$		210	280	mV
					<b>350</b>	
$I_{GND}$	Ground Current	Both LDOs Enabled $I_{OUT} = 0\mu A$		100	140	$\mu A$
		Both LDOs Enabled $I_{OUT} = 300mA$		160		
		One LDO Enabled $I_{OUT} = 0\mu A$		55	75	
		One LDO Enabled $I_{OUT} = 300mA$		85		
$I_{GND-SD}$	Shutdown Ground Current	$V_{EN} < 0.4V$			2	$\mu A$
					<b>4</b>	
PSRR	Power Supply Rejection Ratio	$f = 1kHz$		60		dB
		$f = 20kHz$		45		
$I_{SC}$	Output short circuit current limit	$V_{OUT} = 0V$		130		mA
$T_{ON}$	Turn-On Time			150		$\mu s$
$e_N$	Output Noise Voltage <sup>(3)</sup>	BW = 10Hz to 100kHz		95		$\mu V_{rms}$
$R_{OUT-SH}$	Shutdown Switch Resistance			250		$\Omega$
$V_{IN-UVLO}$	Under voltage lockout threshold			2.15		V
ESR	$C_{OUT}$ equivalent series resistance		5		500	m $\Omega$
<b>Enable Input (EN1, EN2)</b>						
$V_{HI}$	Logic High Level	$V_{IN} = 2.3$ to 5.5V	<b>1.8</b>			V
$V_{LO}$	Logic Low Level	$V_{IN} = 2.3$ to 5.5V			<b>0.4</b>	V
$I_{EN}$	Enable Input Current	$V_{EN} = 0.4V$		0.05	<b>1</b>	$\mu A$
		$V_{EN} = V_{IN}$		0.1	<b>1</b>	
<b>Thermal Protection</b>						
$T_{SD}$	Thermal Shutdown			160		°C
$T_{HYS}$	Thermal Hysteresis			10		°C

**Notes:**

- (1) Specification for 2.8V output version unless specified otherwise.
- (2) Dropout voltage is defined as the input-to-output differential at which the output voltage drops 2% below its nominal value measured at 1V differential. During test, the input voltage stays always above the minimum 2.3V.
- (3) Specification for 1.8V output version.

**TYPICAL CHARACTERISTICS** (shown for 2.8V/1.8V outputs version)

$V_{IN} = 3.8V$ ,  $I_{OUT} = 100\mu A$ ,  $EN1 = EN2 = V_{IN}$ ,  $C_{IN} = C_{OUT} = 1\mu F$ ,  $T_A = 25^\circ C$  unless otherwise specified.

**Output Voltage 1 vs. Temperature**

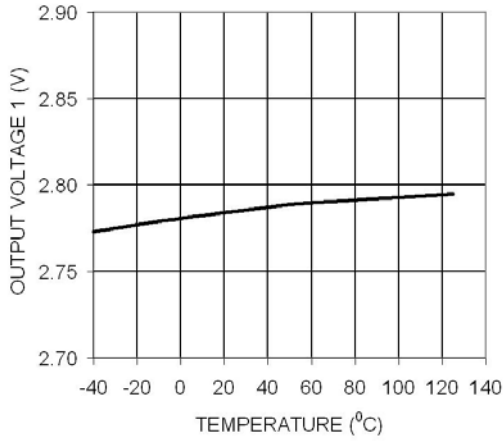

**Output Voltage 2 vs. Temperature**

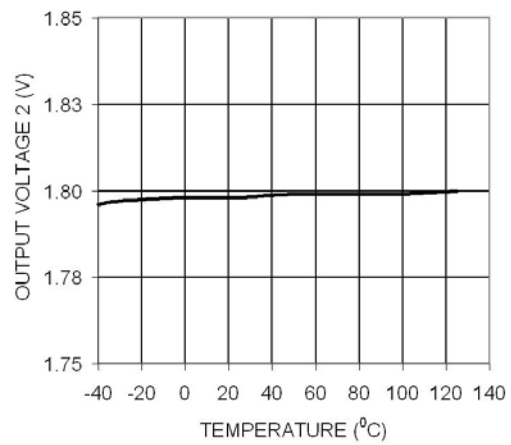

**Load Regulation VOUT1**

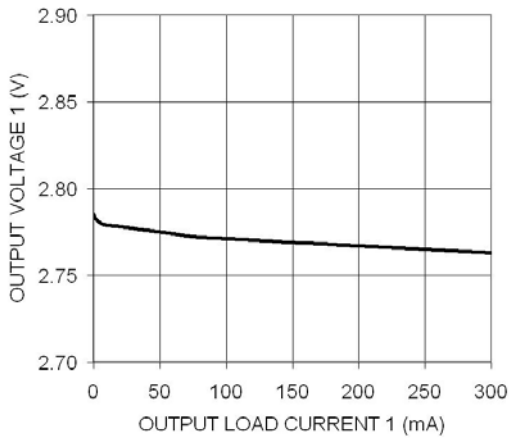

**Load Regulation VOUT2**

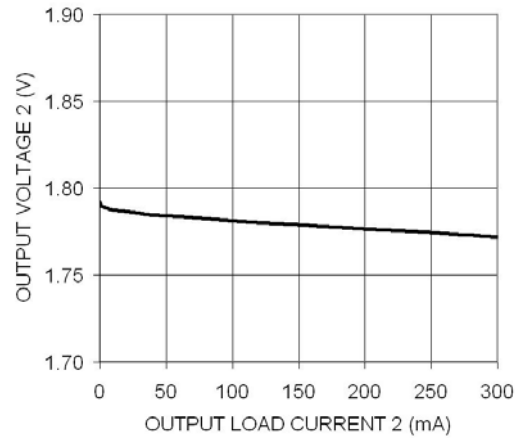

**Ground Current (EN2 = GND)**

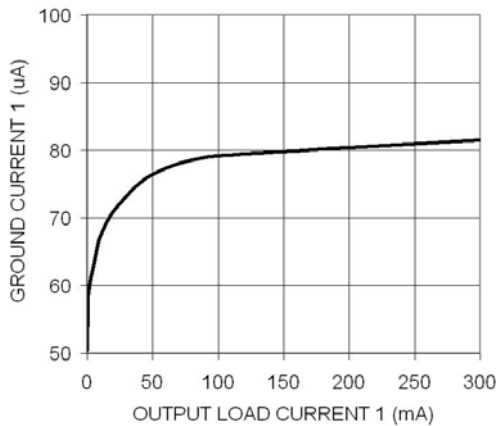

**Ground Current (EN1 = GND)**

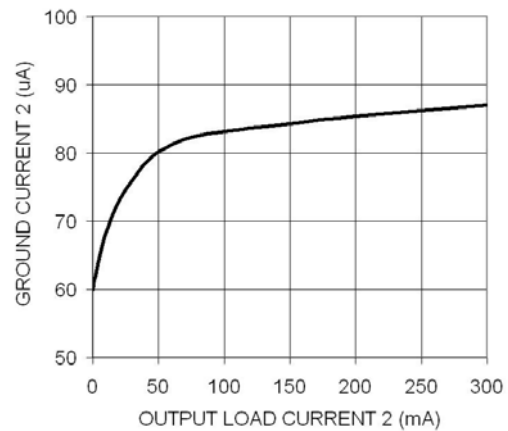

**TYPICAL CHARACTERISTICS** (shown for 2.8V/1.8V outputs option)

$V_{IN} = 3.8V$ ,  $I_{OUT} = 100\mu A$ ,  $EN1 = EN2 = V_{IN}$ ,  $C_{IN} = C_{OUT} = 1\mu F$ ,  $T_A = 25^\circ C$  unless otherwise specified.

**Ground Current (EN2 = GND)**

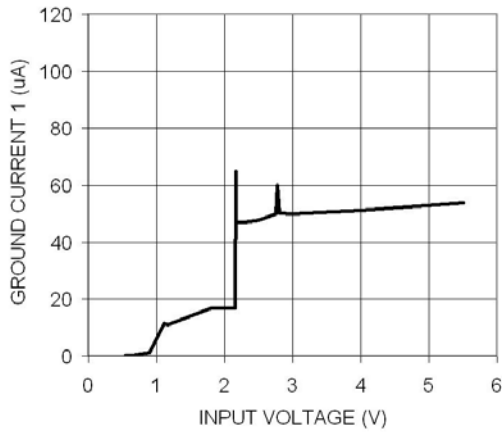

**Ground Current (EN1 = GND)**

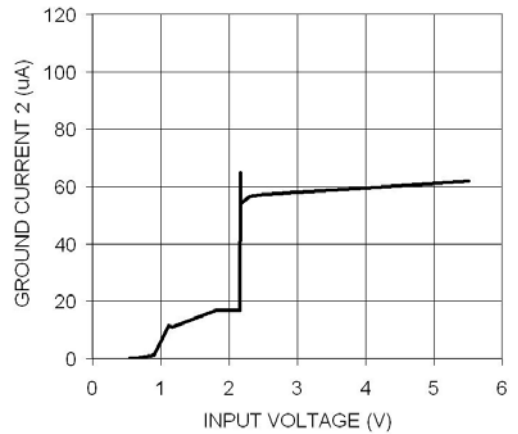

**Output 1 Dropout Characteristics**

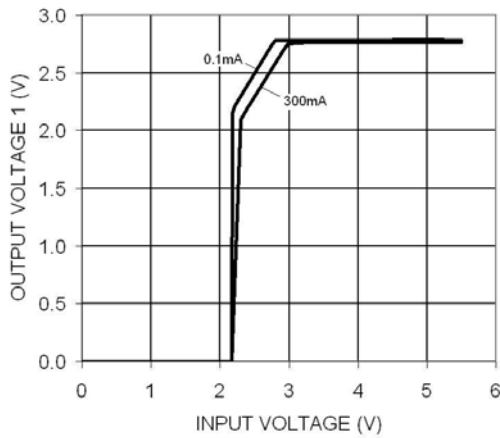

**Ground Current vs. Input Voltage**

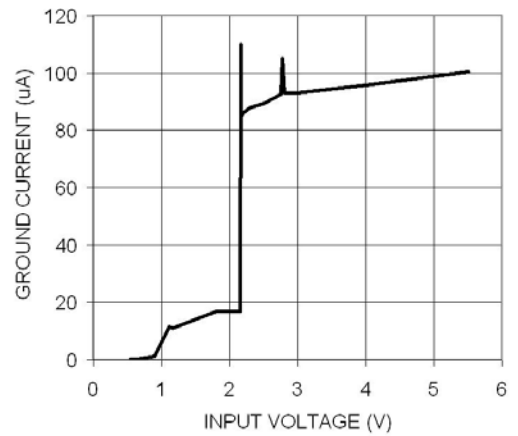

**Output Voltage 1 vs. Load Current 1**

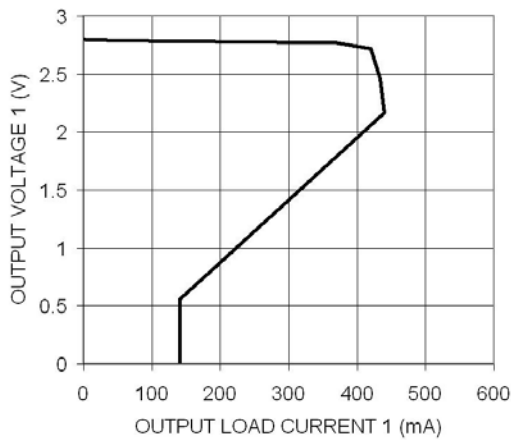

**Output Voltage 2 vs. Load Current 2**

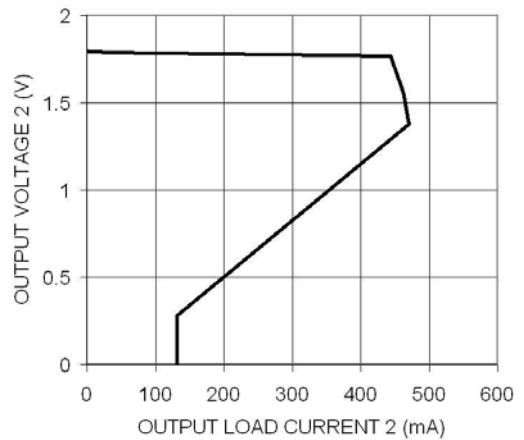

**TYPICAL CHARACTERISTICS** (shown for 2.8V/1.8V outputs option)

$V_{IN} = 3.8V$ ,  $I_{OUT} = 100\mu A$ ,  $EN1 = EN2 = V_{IN}$ ,  $C_{IN} = C_{OUT} = 1\mu F$ ,  $T_A = 25^\circ C$  unless otherwise specified.

**Line Regulation VOUT1**

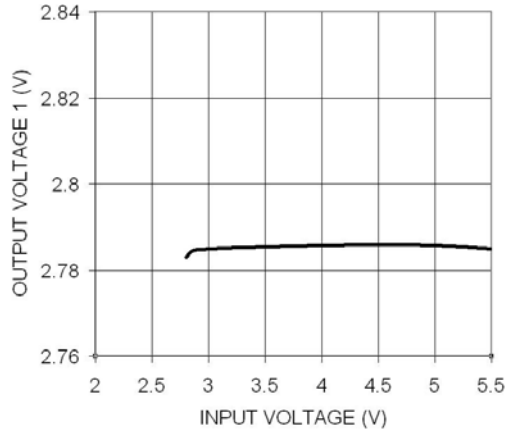

**Line Regulation VOUT2**

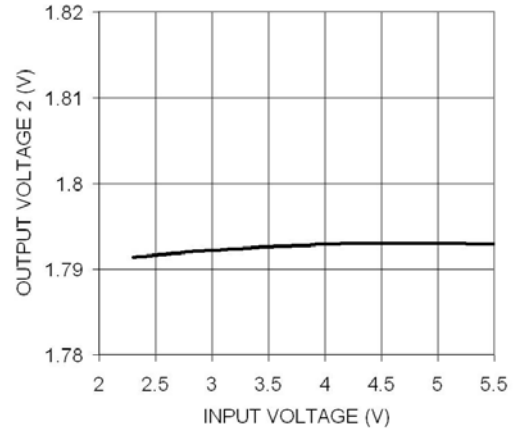

**PSRR 1 & 2 vs. Frequency (30mA Load)**

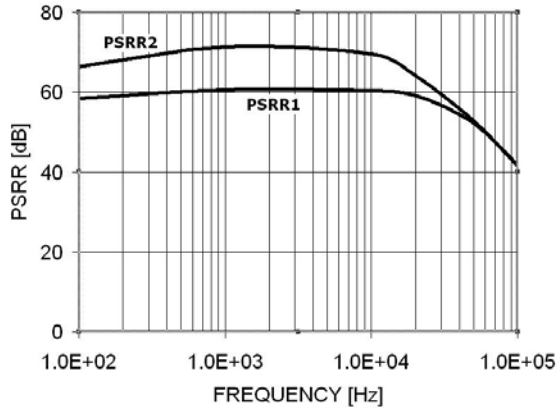

**TRANSIENT CHARACTERISTICS** (shown for 2.8V/1.8V outputs option)

$V_{IN} = 3.8V$ ,  $I_{OUT} = 100\mu A$ ,  $EN1 = EN2 = V_{IN}$ ,  $C_{IN} = C_{OUT} = 1\mu F$ ,  $T_A = 25^\circ C$  unless otherwise specified.

**Note:** All transient characteristics are generated using the evaluation board CAT6221EVAL1.

**Enable Turn-On (100 $\mu$ A Loads)**

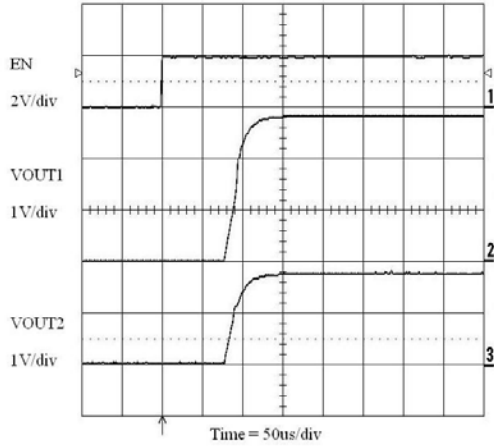

**Enable Turn-Off (100 $\mu$ A Loads)**

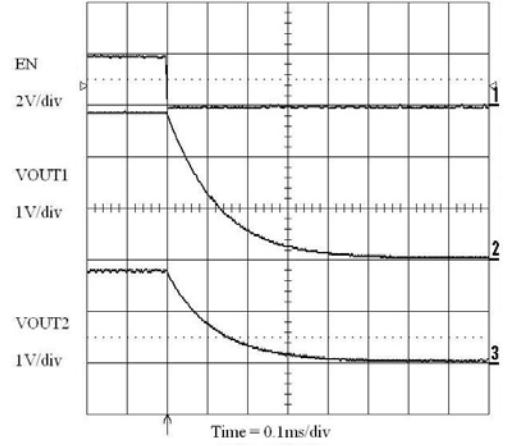

**Enable Turn-On (300mA/100 $\mu$ A Loads)**

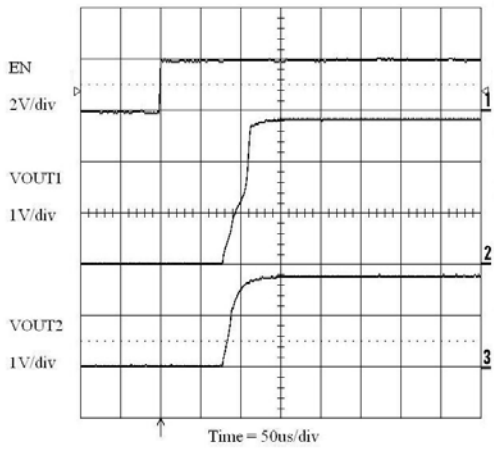

**Enable Turn-Off (300mA/100 $\mu$ A Loads)**

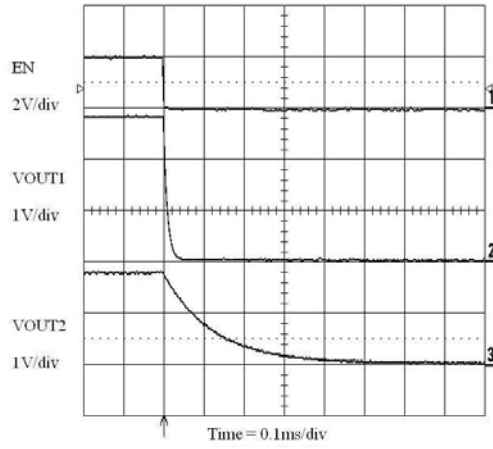

**Enable Turn-On (100 $\mu$ A/300mA Loads)**

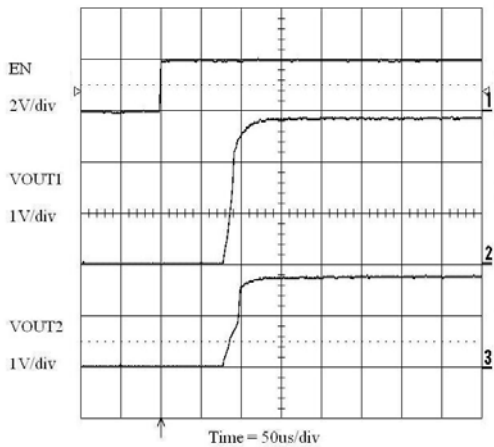

**Enable Turn-Off (100 $\mu$ A/300mA Loads)**

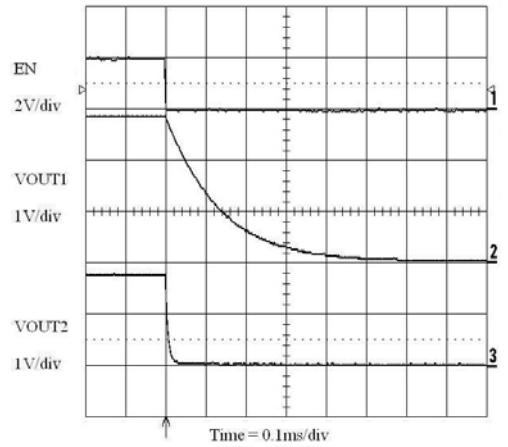

**TRANSIENT CHARACTERISTICS** (shown for 2.8V/1.8V outputs option)

$V_{IN} = 3.8V$ ,  $I_{OUT} = 100\mu A$ ,  $EN1 = EN2 = V_{IN}$ ,  $C_{IN} = C_{OUT} = 1\mu F$ ,  $T_A = 25^\circ C$  unless otherwise specified.

**Note:** All transient characteristics are generated using the evaluation board CAT6221EVAL1.

**VOUT1 Load Transient Response (0.1 to 300mA)**

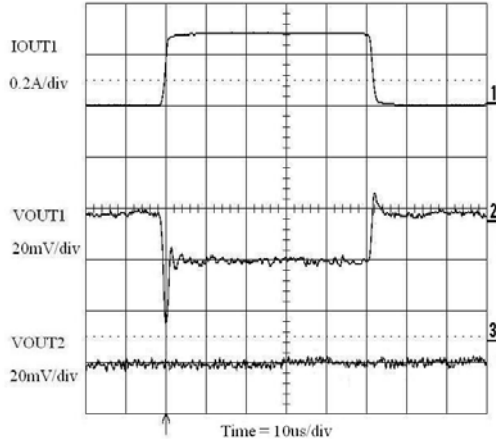

**VOUT2 Load Transient Response (0.1 to 300mA)**

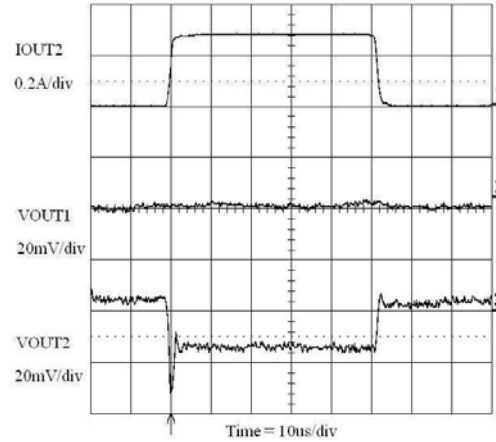

**Line Transient Response (0.1mA Loads)**

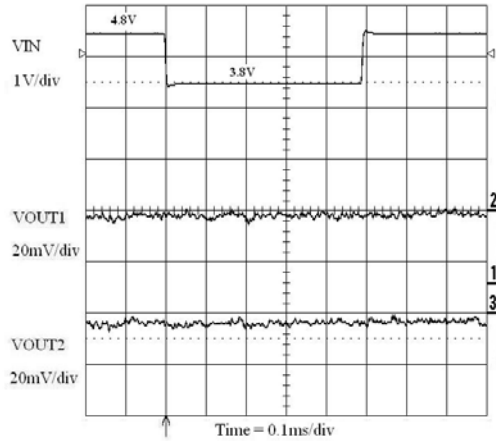

**Line Transient Response (0.1/100mA Loads)**

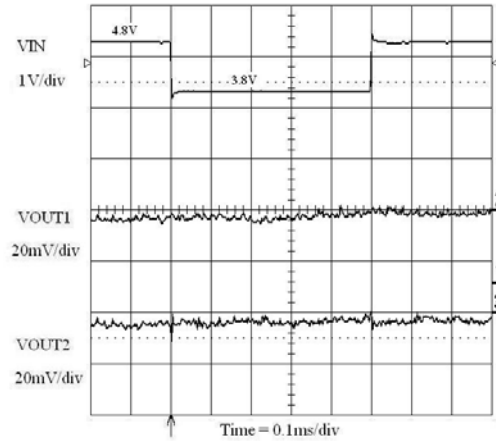

**Line Transient Response (100/0.1mA Loads)**

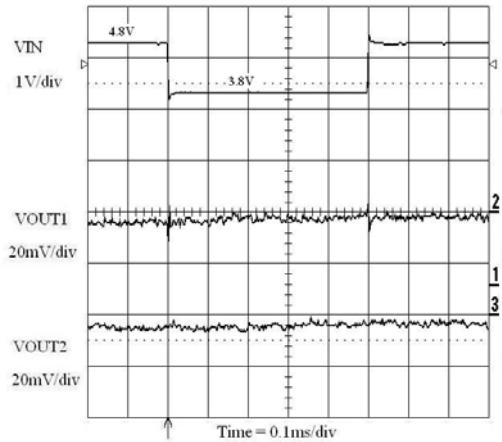

**Separate Enable Operation (100mA Loads)**

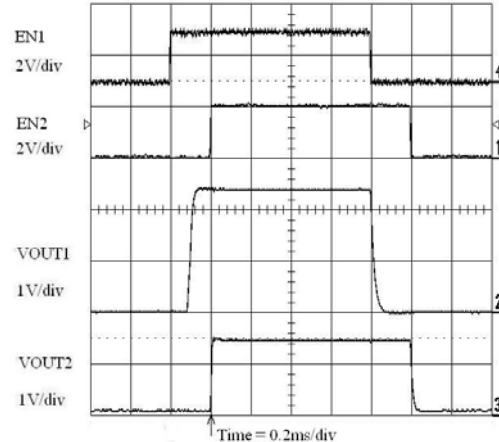



**PACKAGE OUTLINE DRAWING**

TSOT-23 6-Lead 0.8mm (TD)<sup>(1)(2)</sup>

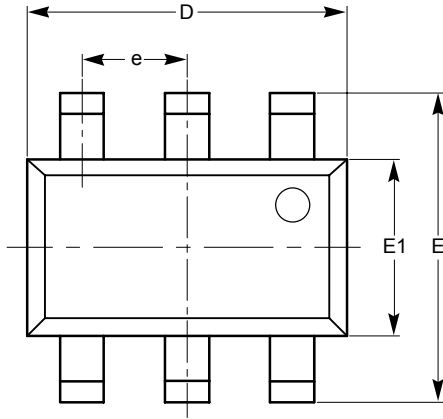

TOP VIEW

SYMBOL	MIN	NOM	MAX
A			1.00
A1	0.01	0.05	0.10
A2	0.80	0.87	0.90
b	0.30		0.45
c	0.12	0.15	0.20
D	2.90 BSC		
E	2.80 BSC		
E1	1.60 BSC		
e	0.95 TYP		
L	0.30	0.40	0.50
L1	0.60 REF		
L2	0.25 BSC		
θ	0°		8°

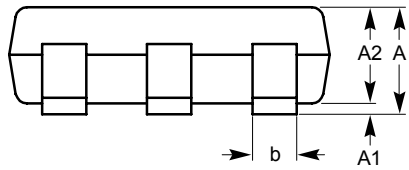

SIDE VIEW

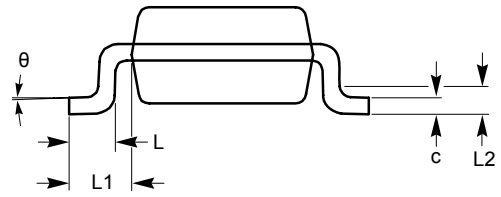

END VIEW

**For current Tape and Reel information, download the PDF file from:  
<http://www.catsemi.com/documents/tapeandreeel.pdf>.**

**Notes:**

- (1) All dimensions are in millimeters, angles in degrees.
- (2) Complies with JEDEC standard MO-193.

**EXAMPLE OF ORDERING INFORMATION**

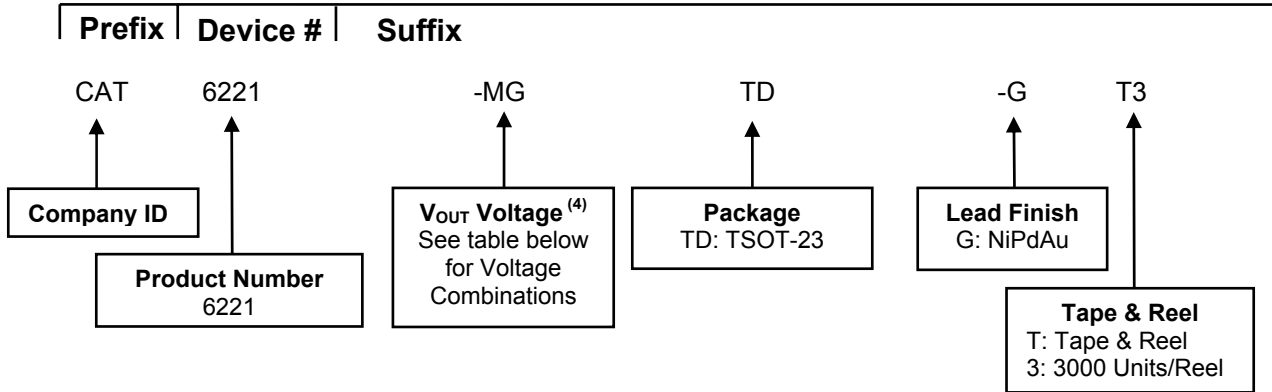

Part Number	V <sub>OUT</sub> Voltage Combination <sup>(4)</sup>	Package	Quantity per Reel
CAT6221-JFTD-G	2.5V / 1.5V	TSOT-23	3000
CAT6221-JGTD-G	2.5V / 1.8V	TSOT-23	3000
CAT6221-JLTD-G	2.5V / 2.7V	TSOT-23	3000
CAT6221-JPTD-G	2.5V / 3.0V	TSOT-23	3000
CAT6221-MFTD-G	2.8V / 1.5V	TSOT-23	3000
CAT6221-MGTD-G	2.8V / 1.8V	TSOT-23	3000
CAT6221-MLTD-G	2.8V / 2.7V	TSOT-23	3000
CAT6221-MPTD-G	2.8V / 3.0V	TSOT-23	3000
CAT6221-PFTD-G	3.0V / 1.5V	TSOT-23	3000
CAT6221-PGTD-G	3.0V / 1.8V	TSOT-23	3000
CAT6221-PLTD-G	3.0V / 2.7V	TSOT-23	3000
CAT6221-PPTD-G	3.0V / 3.0V	TSOT-23	3000
CAT6221-SFTD-G	3.3V / 1.5V	TSOT-23	3000
CAT6221-SGTD-G	3.3V / 1.8V	TSOT-23	3000
CAT6221-SLTD-G	3.3V / 2.7V	TSOT-23	3000
CAT6221-SPTD-G	3.3V / 3.0V	TSOT-23	3000

**Notes:**

- (1) All packages are RoHS-compliant (Lead-free, Halogen-free).
- (2) The standard lead finish is NiPdAu pre-plated (PPF) lead frames.
- (3) The device used in the above example is a CAT6221-MGTD-GT3 (V<sub>OUT1</sub> = 2.8V, V<sub>OUT2</sub> = 1.8V, in a TSOT-23 package, NiPdAu, Tape and Reel).
- (4) For other voltage combinations, please contact your nearest Catalyst Semiconductor Sales office.
- (5) Top marking for CAT6221 is T3YM (Y = Year, M = Month).

## REVISION HISTORY

Date	Rev.	Reason
10/10/2007	A	Initial Release

---

### Copyrights, Trademarks and Patents

© Catalyst Semiconductor, Inc.

Trademarks and registered trademarks of Catalyst Semiconductor include each of the following:

Adaptive Analog™, Beyond Memory™, DPP™, EZDim™, LDD™, MiniPot™, Quad-Mode™ and Quantum Charge Programmable™

Catalyst Semiconductor has been issued U.S. and foreign patents and has patent applications pending that protect its products.

*CATALYST SEMICONDUCTOR MAKES NO WARRANTY, REPRESENTATION OR GUARANTEE, EXPRESS OR IMPLIED, REGARDING THE SUITABILITY OF ITS PRODUCTS FOR ANY PARTICULAR PURPOSE, NOR THAT THE USE OF ITS PRODUCTS WILL NOT INFRINGE ITS INTELLECTUAL PROPERTY RIGHTS OR THE RIGHTS OF THIRD PARTIES WITH RESPECT TO ANY PARTICULAR USE OR APPLICATION AND SPECIFICALLY DISCLAIMS ANY AND ALL LIABILITY ARISING OUT OF ANY SUCH USE OR APPLICATION, INCLUDING BUT NOT LIMITED TO, CONSEQUENTIAL OR INCIDENTAL DAMAGES.*

Catalyst Semiconductor products are not designed, intended, or authorized for use as components in systems intended for surgical implant into the body, or other applications intended to support or sustain life, or for any other application in which the failure of the Catalyst Semiconductor product could create a situation where personal injury or death may occur.

Catalyst Semiconductor reserves the right to make changes to or discontinue any product or service described herein without notice. Products with data sheets labeled "Advance Information" or "Preliminary" and other products described herein may not be in production or offered for sale.

Catalyst Semiconductor advises customers to obtain the current version of the relevant product information before placing orders. Circuit diagrams illustrate typical semiconductor applications and may not be complete.

---



Catalyst Semiconductor, Inc.  
Corporate Headquarters  
2975 Stender Way  
Santa Clara, CA 95054  
Phone: 408.542.1000  
Fax: 408.542.1200  
www.catsemi.com

Document No: MD-10001  
Revision: A  
Issue date: 10/10/07