

# LL4148

## FAST SWITCHING SURFACE MOUNT DIODES

**VOLTAGE** 100 Volts **POWER** 500 mWatts

**MINI-MELF/LL-34** Unit : inch (mm)

### FEATURES

- Fast switching Speed.
- Surface Mount Package Ideally Suited For Automatic Insertion.
- Silicon Epitaxial Planar Construction.
- In compliance with EU RoHS 2002/95/EC directives

### MECHANICAL DATA

- Case: Mini Melf, Glass
- Terminals: Solderable per MIL-STD-750, Method 2026
- Polarity: Cathode Band
- Marking: Cathode Band Only
- Weight: 0.03 grams
- Packing information

T/R - 2.5K per 7" plastic reel

T/R - 10K per 13" plastic reel

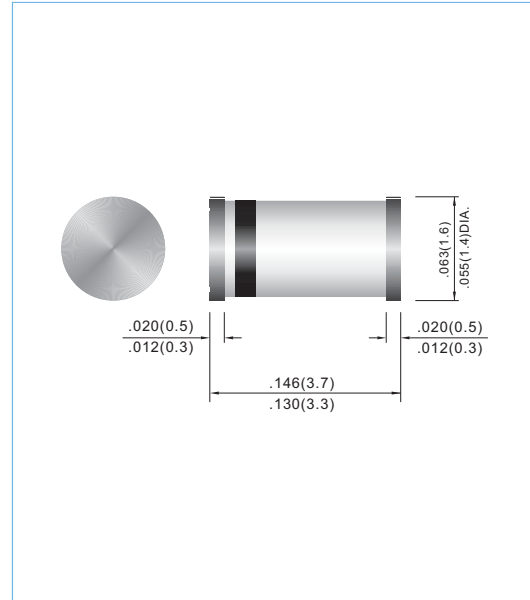

## MAXIMUM RATINGS AND ELECTRICAL CHARACTERISTICS (T<sub>J</sub>=25°C unless otherwise noted)

PARAMETER	SYMBOL	LL4148	UNITS
Peak Reverse Voltage	V <sub>RM</sub>	100	V
Maximum Average Forward Current at T <sub>a</sub> =25 °C And f ≥50Hz	I <sub>AV</sub>	150	mA
Surge Forward Current at t < 1s and T <sub>J</sub> = 25 °C	I <sub>FSM</sub>	500	mA
Power Dissipation at Tamb= 25 °C	P <sub>TOT</sub>	500	mW
Maximum Forward Voltage at I <sub>F</sub> =10mA	V <sub>F</sub>	1.0	V
Maximum Leakage Current at V <sub>R</sub> =20V at V <sub>R</sub> =75V at V <sub>R</sub> =20V ,T <sub>J</sub> = 150°C	I <sub>R</sub>	25 5 50	nA μA μA
Maximum Capacitance at V <sub>F</sub> =V <sub>R</sub> =0	C <sub>J</sub>	4	pF
Maximum Reverse Recovery Time From I <sub>F</sub> =-I <sub>R</sub> =10mA to I <sub>RR</sub> =-1mA ,V <sub>R</sub> =6V R <sub>L</sub> =100 Ω	t <sub>rr</sub>	4	ns
Maximum Thermal Resistance	Rθ <sub>JA</sub>	300	°C / W
Junction Temperature and Storage Temperature Range	T <sub>J</sub> ,T <sub>S</sub>	-65 to +175	°C

**NOTE:**

1. C<sub>J</sub> at V<sub>R</sub>=0, f=1MHZ
2. From I<sub>F</sub>=10mA to I<sub>R</sub>=1mA, V<sub>R</sub>=6Volts, R<sub>L</sub>=100Ω

# LL4148

## RATING AND CHARACTERISTIC CURVES

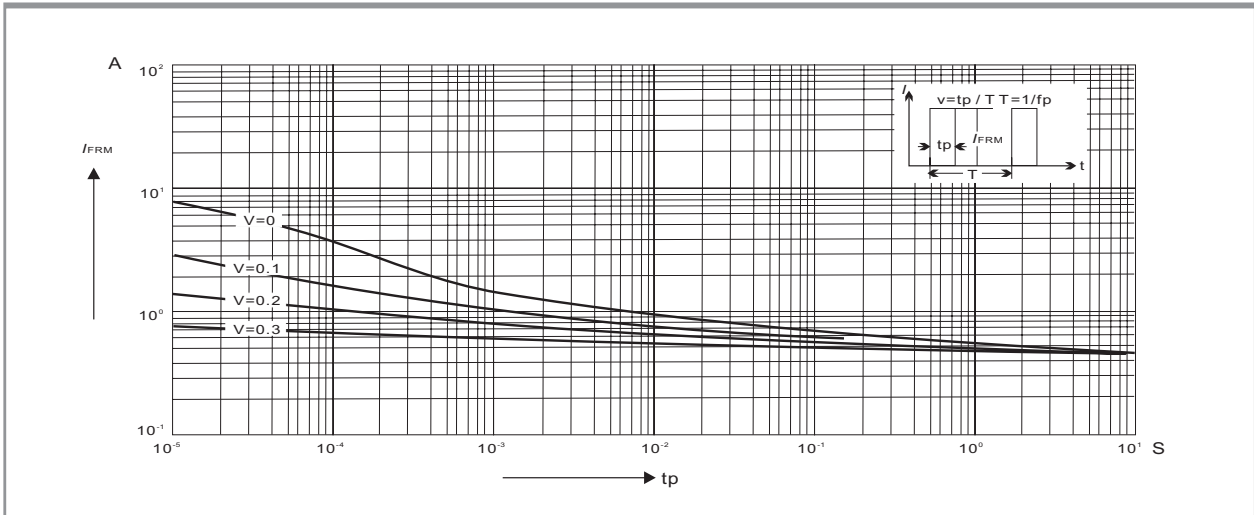

Fig.1 ADMISSIBLE REPETITIVE PEAK FORWARD CURRENT VERSUS PULSE DURATION

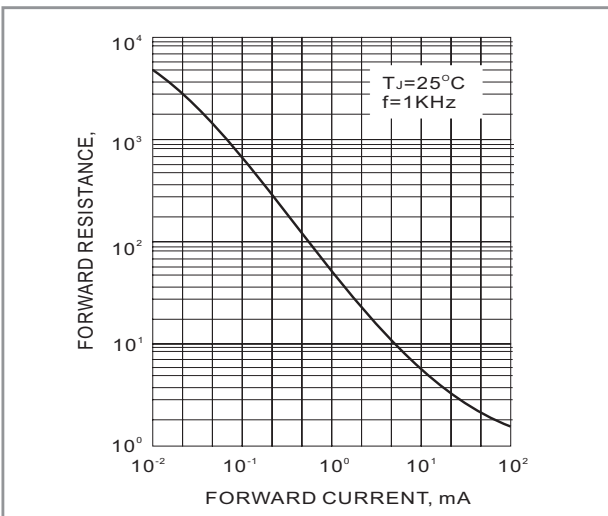

Fig.2-DYNAMIC FORWARD RESISTANCE VERSUS FORWARD CURRENT

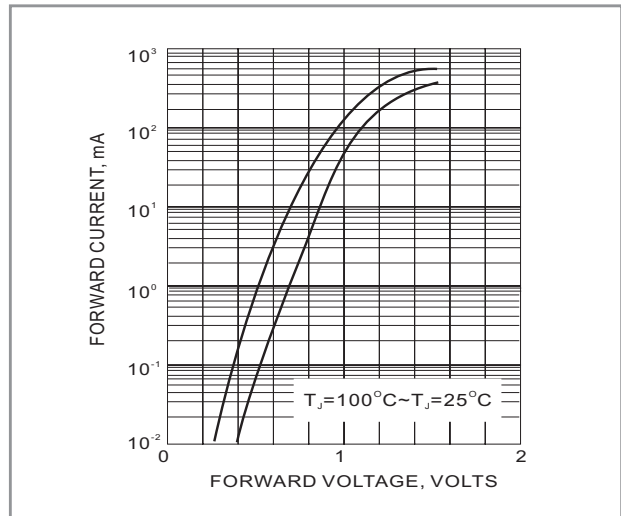

Fig.3 FORWARD CHARACTERISTICS

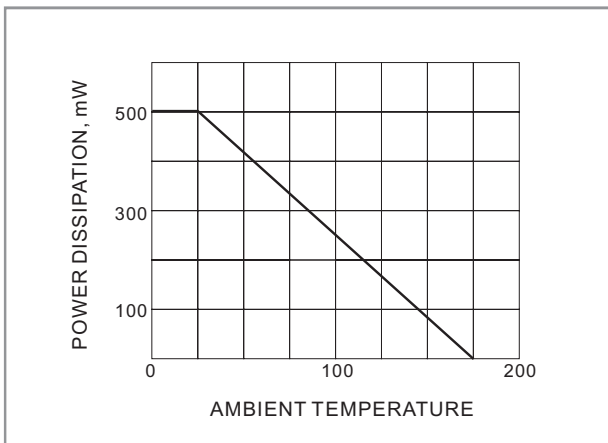

Fig.4 DERATING CURVE

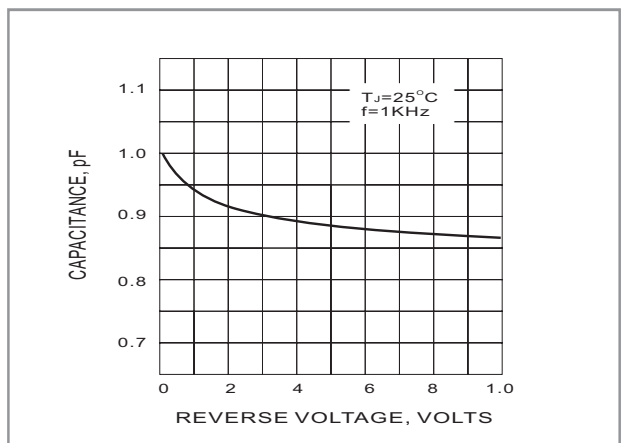
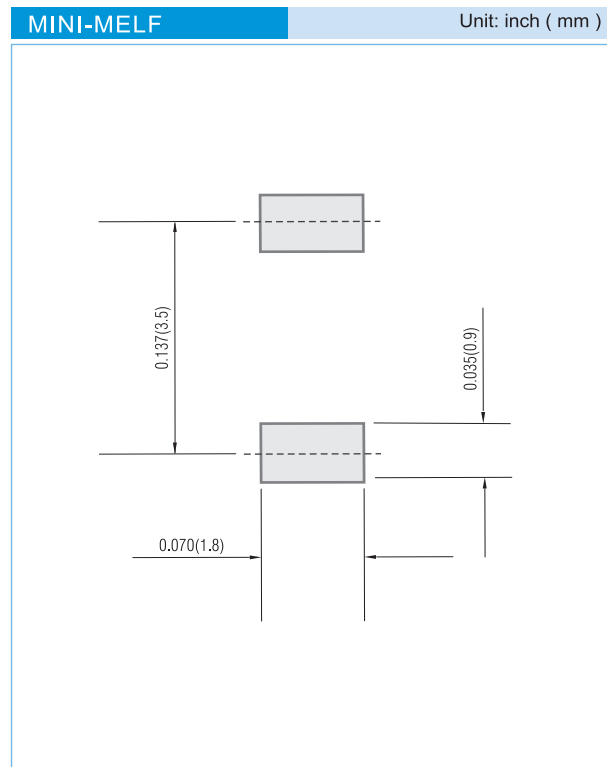

Fig.5 TYPICAL JUNCTION CAPACITANCE

# LL4148

## MOUNTING PAD LAYOUT



## ORDER INFORMATION

- Packing information
  - T/R - 10K per 13" plastic Reel
  - T/R - 2.5K per 7" plastic Reel

## LEGAL STATEMENT

### Copyright PanJit International, Inc 2007

The information presented in this document is believed to be accurate and reliable. The specifications and information herein are subject to change without notice. Pan Jit makes no warranty, representation or guarantee regarding the suitability of its products for any particular purpose. Pan Jit products are not authorized for use in life support devices or systems. Pan Jit does not convey any license under its patent rights or rights of others.