

VRE3041 Low Cost Precision Reference

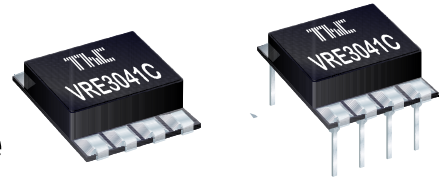

THALER CORPORATION • 2015 N. FORBES BOULEVARD • TUCSON, AZ. 85745 • (520) 882-4000

FEATURES

- 4.096 V Output \pm 0.409 mV (.01%)
- Temperature Drift: 0.6 ppm/ $^{\circ}$ C
- Low Noise: 3 μ V_{p-p} (0.1Hz-10Hz)
- Low Thermal Hysteresis: 1 ppm Typ.
- \pm 15mA Output Source and Sink Current
- Excellent Line Regulation: 5 ppm/V Typ.
- Optional Noise Reduction and Voltage Trim
- Industry Standard Pinout

PIN CONFIGURATION

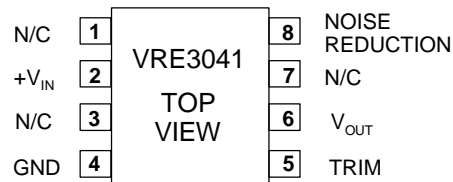

FIGURE 1

DESCRIPTION

The VRE3041 is a low cost, high precision 4.096V reference that operates from +10V. The device features a buried zener for low noise and excellent long term stability. Packaged in an 8 pin DIP and SMT, the device is ideal for high resolution data conversion systems.

The device provides ultrastable +4.096V output with \pm 0.4096 mV (.01%) initial accuracy and a temperature coefficient of 0.6 ppm/ $^{\circ}$ C. This improvement in accuracy is made possible by a unique, patented multipoint laser compensation technique developed by Thaler Corporation. Significant improvements have been made in other performance parameters as well, including initial accuracy, warm-up drift, line regulation, and long-term stability, making the VRE3041 series the most accurate reference available.

For enhanced performance, the VRE3041 has an external trim option for users who want less than 0.01% initial error. For ultra low noise applications, an external capacitor can be attached between the noise reduction pin and the ground pin.

The VRE3041 is recommended for use as a reference for 14, 16, or 18 bit data converters which require an external precision reference. The device is also ideal for calibrating scale factor on high resolution data converters. The VRE3041 offers superior performance over monolithic references.

SELECTION GUIDE

Model	Initial Error mV	Temp. Coeff. ppm/ $^{\circ}$ C	Temp. Range $^{\circ}$ C
VRE3041A	0.410	0.6	0 $^{\circ}$ C to +70 $^{\circ}$ C
VRE3041B	0.614	1.0	0 $^{\circ}$ C to +70 $^{\circ}$ C
VRE3041C	0.820	2.0	0 $^{\circ}$ C to +70 $^{\circ}$ C
VRE3041J	0.410	0.6	-40 $^{\circ}$ C to +85 $^{\circ}$ C
VRE3041K	0.614	1.0	-40 $^{\circ}$ C to +85 $^{\circ}$ C
VRE3041L	0.820	2.0	-40 $^{\circ}$ C to +85 $^{\circ}$ C

For package option add D for DIP or S for Surface Mount to end of model number.

ABSOLUTE MAXIMUM RATINGS

Power Supply	-0.3V to +40V	Out Short Circuit to GND Duration ($V_{IN} < 12V$).....	Continuous
OUT, TRIM	-0.3V to +12V	Out Short Circuit to GND Duration ($V_{IN} < 40V$).....	5 sec
NR.....	-0.3V to +6V	Out Short Circuit to IN Duration ($V_{IN} < 12V$).....	Continuous
Operating Temp. (A,B,C).....	0 °C to 70°C	Continuous Power Dissipation ($T_A = +70°C$).....	300mW
Operating Temp. (J,K,L).....	-40 °C to 85°C	Storage Temperature.....	-65°C to 150°C
		Lead Temperature (soldering, 10 sec).....	250°C

ELECTRICAL SPECIFICATIONS

Vps =+10V, T = 25°C, Iout=0mA unless otherwise noted.

PARAMETER	SYMBOL	CONDITIONS	MIN	TYP	MAX	UNITS
Input Voltage	V_{IN}		8		36	V
Output Voltage (Note 1)	V_{OUT}	VRE3041A/J	4.0956	4.096	4.0964	V
		VRE3041B/K	4.0954	4.096	4.0966	
		VRE3041C/L	4.0952	4.096	4.0968	
Output Voltage Temperature Coefficient (Note 2)	TCV_{OUT}	VRE3041A/J		0.3	0.6	ppm/°C
		VRE3041B/K		0.5	1.0	
		VRE3041C/K		1.0	2.0	
Trim Adjustment Range	ΔV_{OUT}	Figure 3		±4		mV
Turn-On Settling Time	T_{on}	To 0.01% of final value		2		µs
Output Noise Voltage	e_n	0.1Hz<f<10Hz		2.4		µVp-p
		10Hz<f<1kHz		2	4	µV _{RMS}
Temperature Hysterisis		Note 4		1		ppm
Long Term Stability	$\Delta V_{OUT/t}$			6		ppm/ 1khrs
Supply Current	I_{IN}			3.5	4.0	mA
Load Regulation	$\frac{\Delta V_{OUT}}{\Delta I_{OUT}}$	Sourcing: 0mA ≤ I _{OUT} ≤ 15mA		8	12	ppm/ mA
		Sinking: -15mA ≤ I _{OUT} ≤ 0mA		8	12	
Line Regulation	$\frac{\Delta V_{OUT}}{\Delta V_{IN}}$	8V ≤ V _{IN} ≤ 10V		25	35	ppm/V
		10V ≤ V _{IN} ≤ 18V		5	10	

Notes:

- 1) The specified values are without external trim.
- 2) The temperature coefficient is determined by the box method. See discussion on temperature performance.
- 3) Line and load regulation are measured with pulses and do not include voltage changes due to temperature.
- 4) Hysterisis measured over the operating temperature range.

TYPICAL PERFORMANCE CURVES

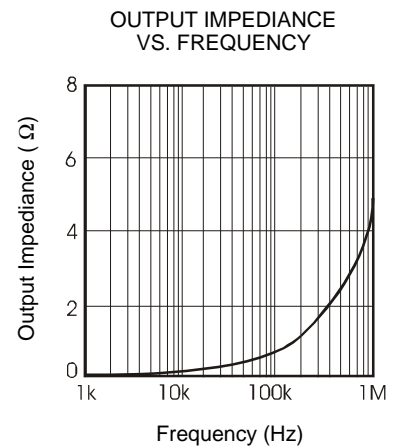
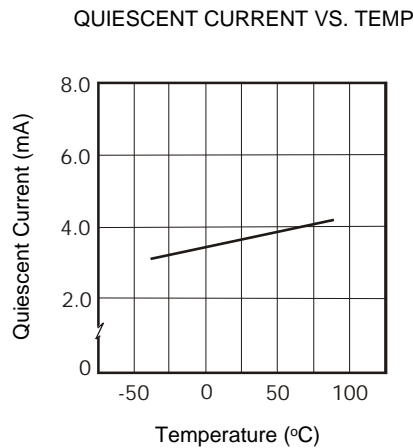
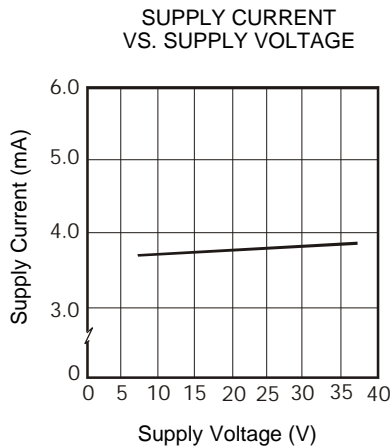
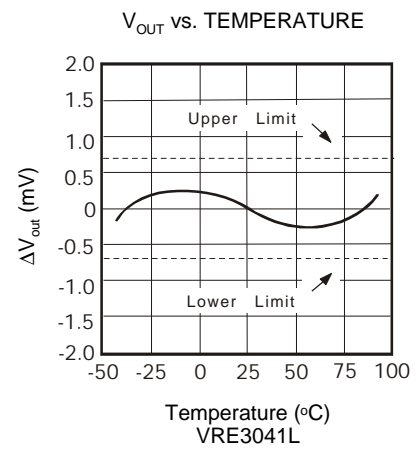
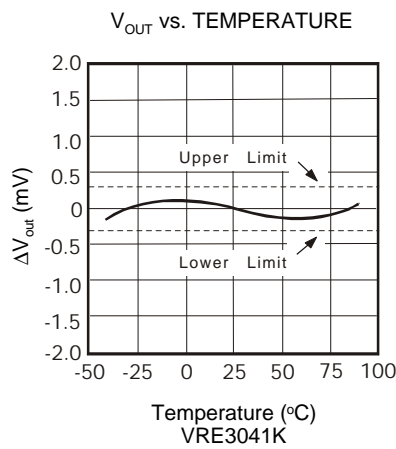
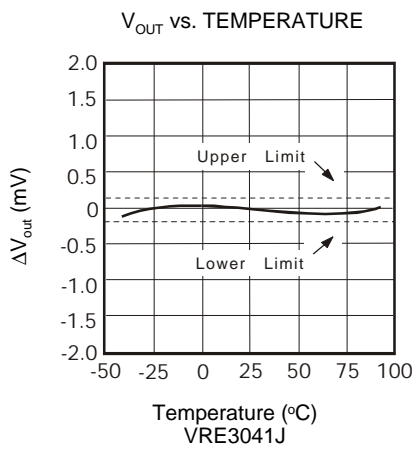
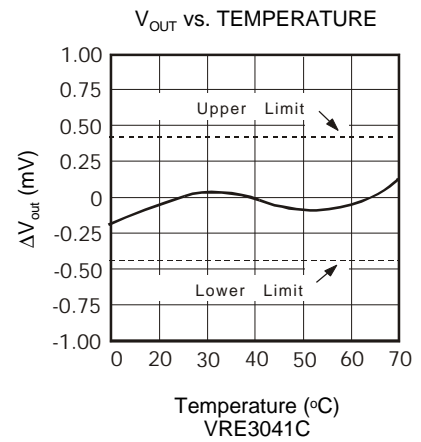
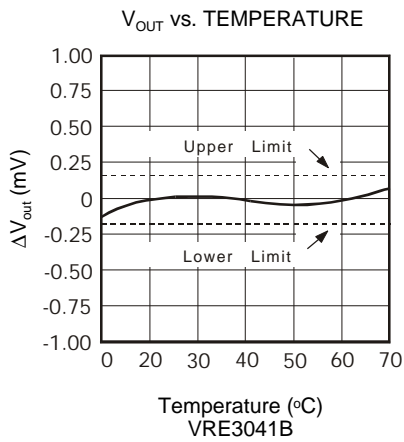
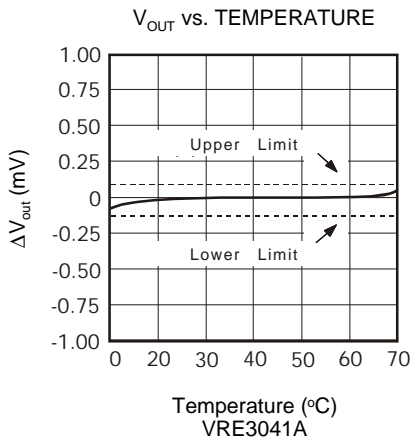

TYPICAL PERFORMANCE CURVES

JUNCTION TEMP. RISE VS. OUTPUT CURRENT

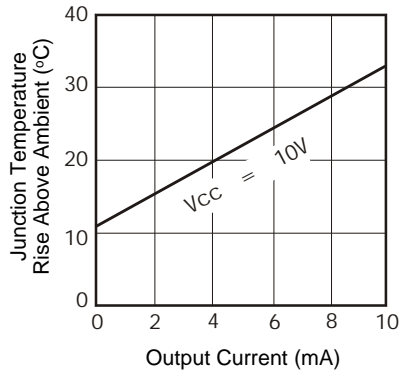

RIPPLE REJECTION Vs. FREQUENCY ($C_{NR}=0\mu F$)

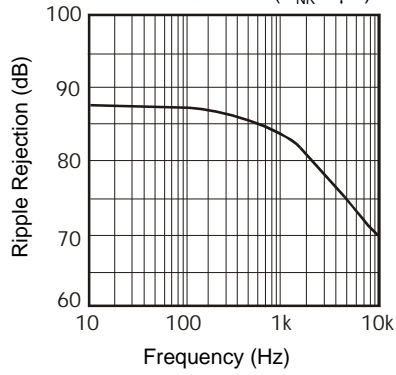

TURN-ON AND TURN-OFF TRANSIENT RESPONSE

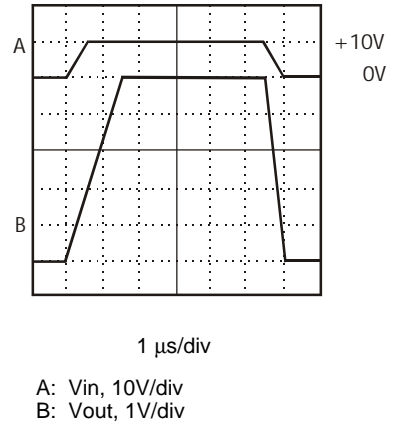

OUTPUT NOISE-VOLTAGE DENSITY vs. FREQUENCY

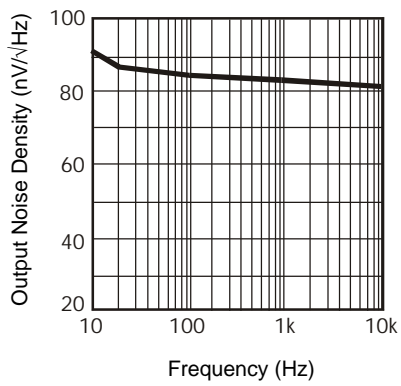

CHANGE IN OUTPUT VOLTAGE VS. OUTPUT CURRENT

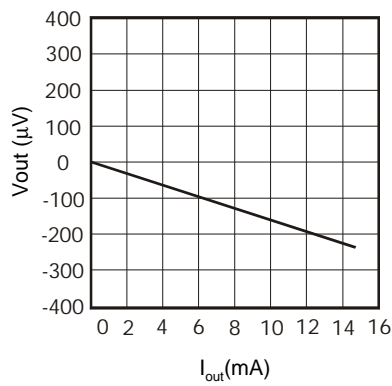

CHANGE IN OUTPUT VOLTAGE VS. INPUT VOLTAGE

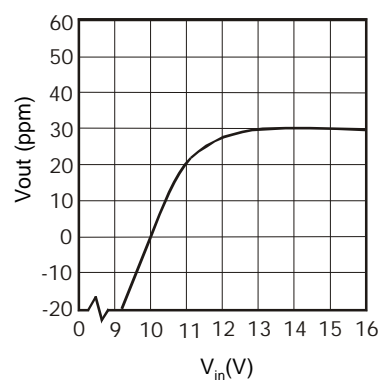

0.1Hz to 10Hz Noise

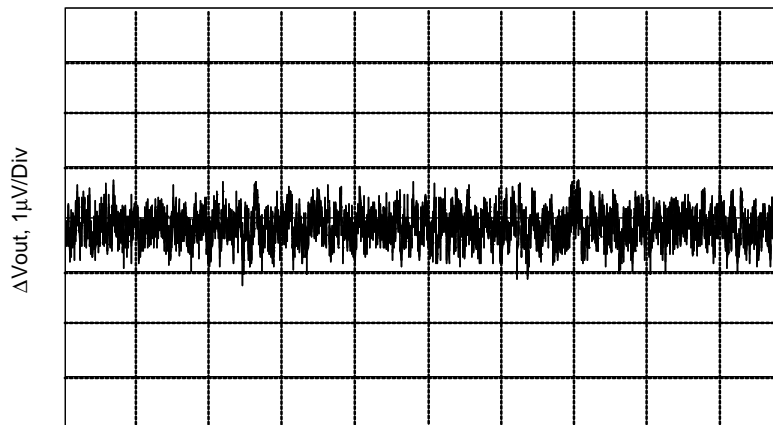

THEORY OF OPERATION

The following discussion refers to the schematic in figure 2 below. A FET current source is used to bias a 6.3V zener diode. The zener voltage is divided by the resistor network R1 and R2. This voltage is then applied to the noninverting input of the operational amplifier which amplifies the voltage to produce a 4.096V output. The gain is determined by the resistor networks R3 and R4: $G=1 + R4/R3$. The 6.3V zener diode is used because it is the most stable diode over time and temperature.

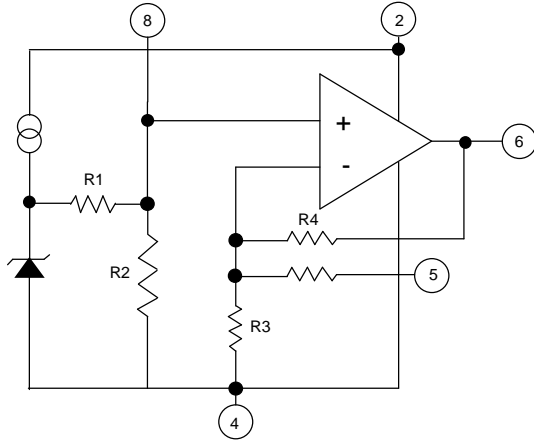

Figure 2 Functional Block Diagram

The current source provides a closely regulated zener current, which determines the slope of the references' voltage vs. temperature function. By trimming the zener current a lower drift over temperature can be achieved. But since the voltage vs. temperature function is nonlinear this compensation technique is not well suited for wide temperature ranges.

Thaler Corporation has developed a nonlinear compensation network of thermistors and resistors that is used in the VRE series voltage references. This proprietary network eliminates most of the nonlinearity in the voltage vs. temperature function. By adjusting the slope, Thaler Corporation produces a very stable voltage over wide temperature ranges.

This network is less than 2% of the overall network resistance so it has a negligible effect on long term stability. Figure 3 shows the proper connection of the VRE3041 series voltage references with the optional trim resistor for initial error and the optional capacitor for noise reduction.

PIN DESCRIPTION

1,3,7	N.C.	Internally connected. Do not use
2	V _{in}	Positive power supply input
4	GND	Ground
5	TRIM	External trim input. Leave open if not used.
6	OUT	Voltage reference output
8	NR	Noise Reduction

BASIC CIRCUIT CONNECTION

Figure 3 shows the proper connection of the VRE3041 voltage reference with the optional trim resistor for initial error and optional capacitor for noise reduction.

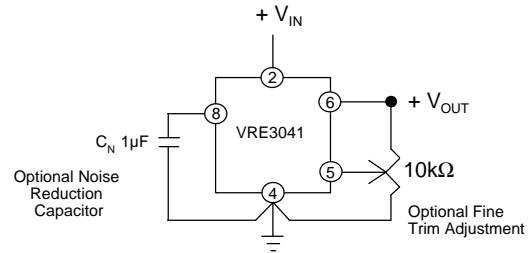

Figure 3 External Connections

To achieve the specified performance, pay careful attention to the layout. A low resistance star configuration will reduce voltage errors, noise pickup, and noise coupled from the power supply. Commons should be connected to a single point to minimize interconnect resistances.

TEMPERATURE PERFORMANCE

The VRE3041 is designed for applications where the initial error at room temperature and drift over temperature are important to the user. For many instrument manufacturers, a voltage reference with a temperature coefficient less than 1ppm/°C makes it possible to not have to perform a system temperature calibration, a slow and costly process.

Of the three TC specification methods (slope, butterfly, and box), the box method is used commonly used. A box is formed by the min/max limits for the nominal output voltage over the operating temperature range. The equation follows:

$$T.C. = \left(\frac{V_{\max} - V_{\min}}{V_{\text{nominal}} \cdot (T_{\max} - T_{\min})} \right) \cdot 10^6$$

This method corresponds more accurately to the method of test and provides a closer estimate of actual error than the other methods. The box method guarantees limits for the temperature error but does not specify the exact shape and slope of the device under test.

A designer who needs a 14-bit accurate data acquisition system over the industrial temperature range (-40°C to +85°C), will need a voltage reference with a temperature coefficient (TC) of 1.0ppm/°C if the reference is allowed to contribute an error equivalent to 1LSB. For 1/2LSB equivalent error from the reference you would need a voltage reference with a temperature coefficient of 0.5ppm/°C. Figure 4 shows the required reference TC vs. delta T change from 25°C for resolution ranging from 8 bits to 20 bits.

THERMAL HYSTERISIS

A change in output voltage as a result of a temperature change. When references experience a temperature change and return to the initial temperature, they do not always have the same initial voltage. Thermal hysteresis is difficult to correct and is a major error source in systems that experience temperature changes greater than 25°C. Reference vendors are starting to include this important specification in their datasheets.

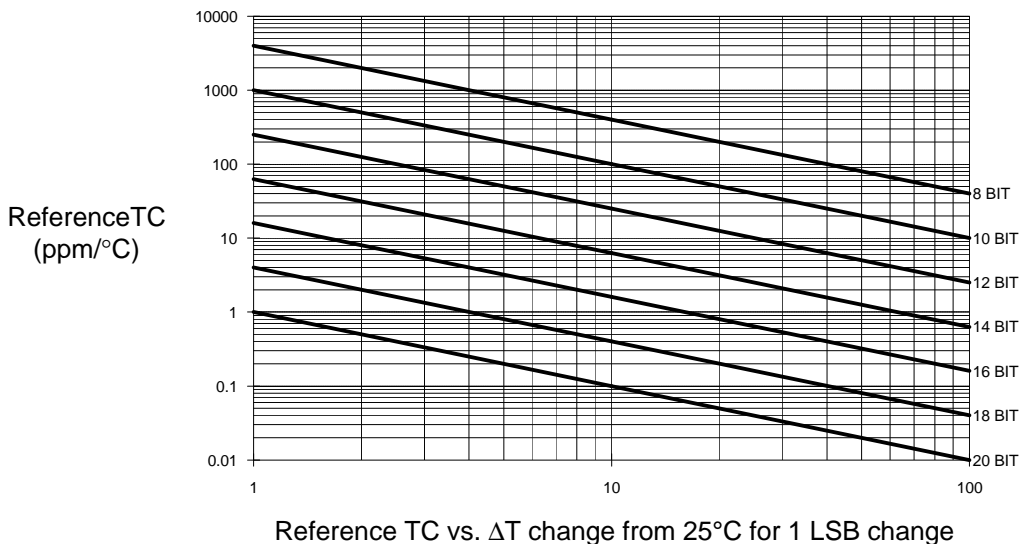

MECHANICAL SPECIFICATIONS

DIM	INCHES		MILLIMETER		DIM	INCHES		MILLIMETER	
	MIN	MAX	MIN	MAX		MIN	MAX	MIN	MAX
A	.110	.120	2.794	3.048	D1	.372	.380	9.45	9.65
B	.095	.105	2.413	2.667	E	.425	.435	10.80	11.05
B1	.021	.027	0.533	0.686	E1	.397	.403	10.08	10.24
C	.055	.065	1.397	1.651	E2	.264	.270	6.71	6.86
C1	.012	.020	0.305	0.508	P	.085	.095	2.16	2.41
C2	.020	.040	0.508	1.016	S	.045	.055	1.14	1.40
D	.395	.405	10.03	10.29					

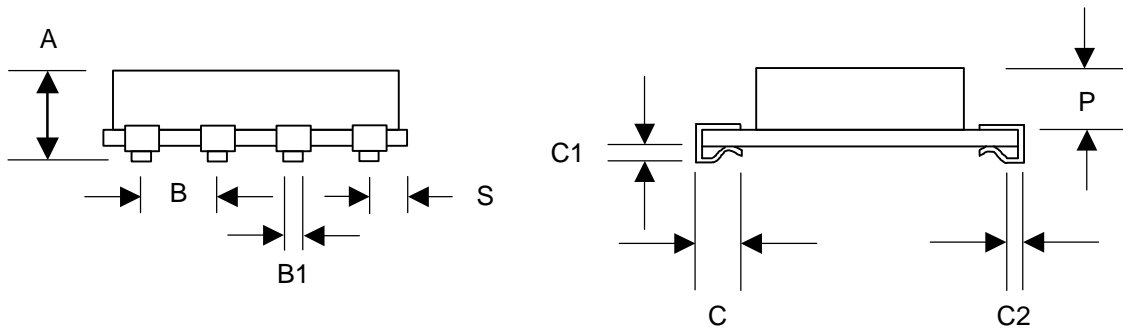
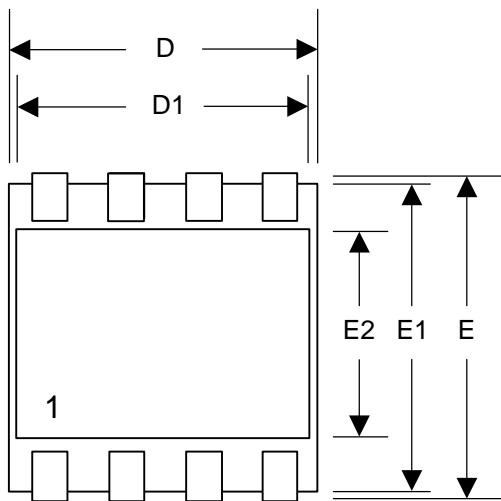

MECHANICAL SPECIFICATIONS

DIM	INCHES		MILLIMETER		DIM	INCHES		MILLIMETER	
	MIN	MAX	MIN	MAX		MIN	MAX	MIN	MAX
A	.170	.180	4.318	4.572	E	.425	.435	10.80	11.05
B	.095	.105	2.413	2.667	E1	.397	.403	10.08	10.24
B1	.016	.020	0.406	0.508	E2	.264	.270	6.71	6.86
C	.008	.011	0.203	0.279	G	.290	.310	7.36	7.87
C1	.055	.065	1.397	1.651	L	.175	.225	4.46	5.72
D	.395	.405	10.03	10.29	P	.085	.095	2.16	2.41
D1	.372	.380	9.45	9.65	S	.045	.055	1.14	1.40

