



NPN SILICON HIGH FREQUENCY TRANSISTOR

UPA808T

FEATURES

- **SMALL PACKAGE STYLE:**
2 NE687 Die in a 2 mm x 1.25 mm package
- **LOW NOISE FIGURE:**
NF = 1.3 dB TYP at 2 GHz
- **HIGH GAIN:**
 $IS_{21EI}^2 = 8.5$ dB TYP at 2 GHz
- **LOW CURRENT OPERATION**

DESCRIPTION

NEC's UPA808T is two NPN high frequency silicon epitaxial transistors encapsulated in an ultra small 6 pin SMT package. Each transistor is independently mounted and easily configured for either dual transistor or cascode operation. The high ft, low voltage bias and small size make this device suited for various hand-held wireless applications.

OUTLINE DIMENSIONS (Units in mm)

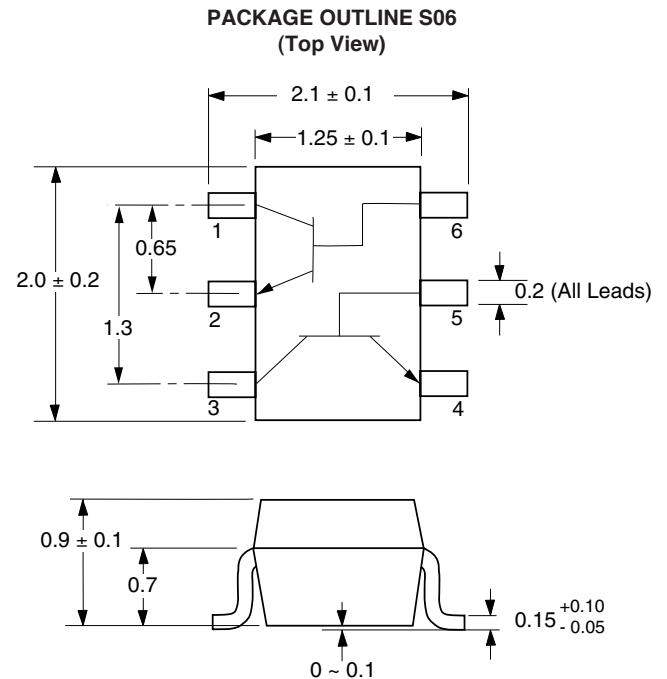

- PIN OUT**
1. Collector Transistor 1
 2. Emitter Transistor 1
 3. Collector Transistor 2
 4. Emitter Transistor 2
 5. Base Transistor 2
 6. Base Transistor 1

Note:
Pin 3 is identified with a circle on the bottom of the package.

ELECTRICAL CHARACTERISTICS (TA = 25°C)

PART NUMBER PACKAGE OUTLINE			UPA808T S06		
SYMBOLS	PARAMETERS AND CONDITIONS	UNITS	MIN	TYP	MAX
ICBO	Collector Cutoff Current at VCB = 5 V, IE = 0	μA			0.1
IEBO	Emitter Cutoff Current at VEB = 1 V, IC = 0	μA			0.1
hFE ¹	Forward Current Gain at VCE = 2 V, IC = 20 mA		70	100	140
fT	Gain Bandwidth at VCE = 2 V, IC = 20 mA, f = 2 GHz	GHz	9	11	
Cre ²	Feedback Capacitance at VCB = 2 V, IE = 0, f = 1 MHz	pF		0.4	0.8
IS _{21EI} ²	Insertion Power Gain at VCE = 2 V, IC = 20 mA, f = 2 GHz	dB	7	8.5	
NF	Noise Figure at VCE = 2 V, IC = 3 mA, f = 2 GHz	dB		1.3	2
hFE1/hFE2	hFE Ratio: hFE1 = Smaller Value of Q1, or Q2 hFE2 = Larger Value of Q1 or Q2		0.85		

- Notes:**
1. Pulsed measurement, pulse width ≤ 350 μs, duty cycle ≤ 2 %.
 2. The emitter terminal should be connected to the ground terminal of the 3 terminal capacitance bridge.
- For Tape and Reel version use part number UPA808T-T1, 3K per reel.

ABSOLUTE MAXIMUM RATINGS¹ ($T_A = 25^\circ\text{C}$)

SYMBOLS	PARAMETERS	UNITS	RATINGS
V _{CB0}	Collector to Base Voltage	V	5
V _{CE0}	Collector to Emitter Voltage	V	3
V _{EB0}	Emitter to Base Voltage	V	2
I _c	Collector Current	mA	30
P _T	Total Power Dissipation		
	1 Die	mW	90
	2 Die	mW	180
T _J	Junction Temperature	°C	150
T _{STG}	Storage Temperature	°C	-65 to +150

Note: 1. Operation in excess of any one of these parameters may result in permanent damage.

TYPICAL PERFORMANCE CURVES ($T_A = 25^\circ\text{C}$)

TOTAL POWER DISSIPATION vs. AMBIENT TEMPERATURE

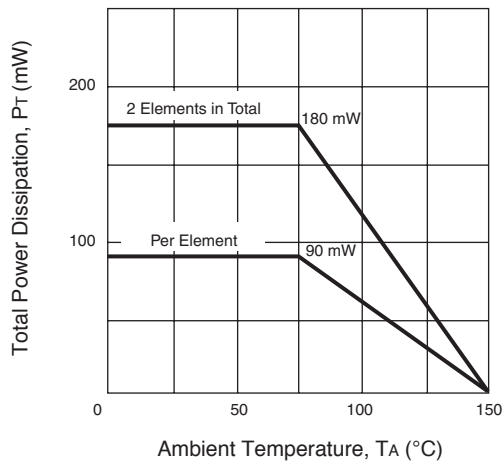

COLLECTOR CURRENT vs. BASE TO EMITTER VOLTAGE

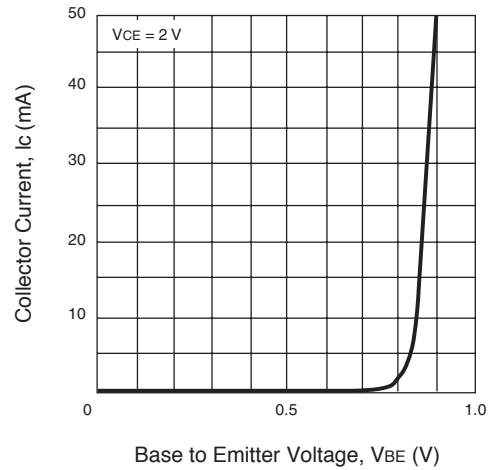

COLLECTOR CURRENT vs. COLLECTOR TO EMITTER VOLTAGE

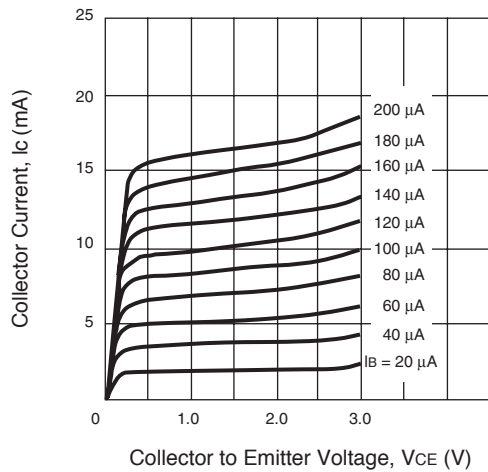

DC CURRENT GAIN vs. COLLECTOR CURRENT

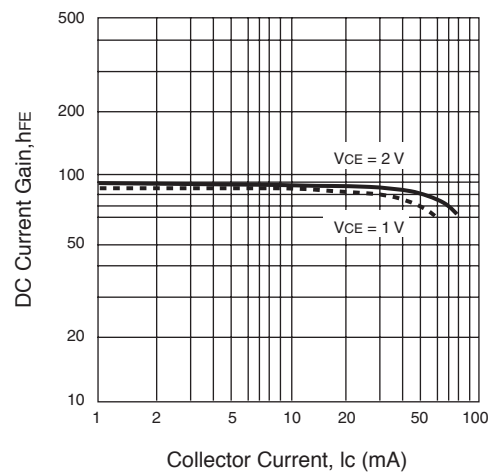

TYPICAL PERFORMANCE CURVES ($T_A = 25^\circ\text{C}$)

GAIN BANDWIDTH PRODUCT vs. COLLECTOR CURRENT

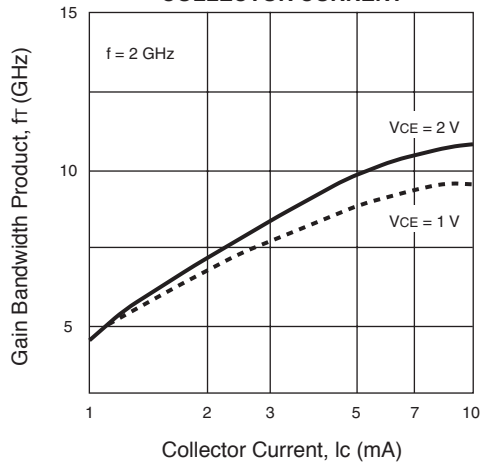

INSERTION POWER GAIN vs. COLLECTOR CURRENT

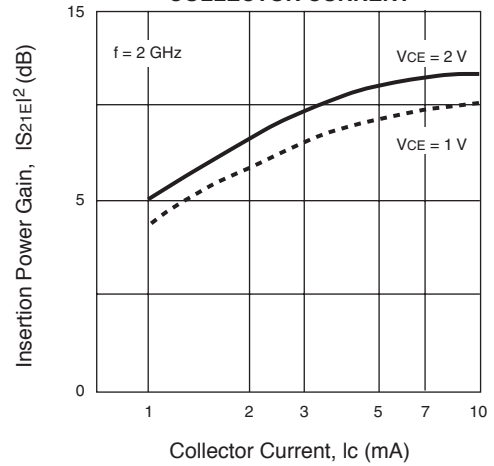

NOISE FIGURE vs. COLLECTOR CURRENT

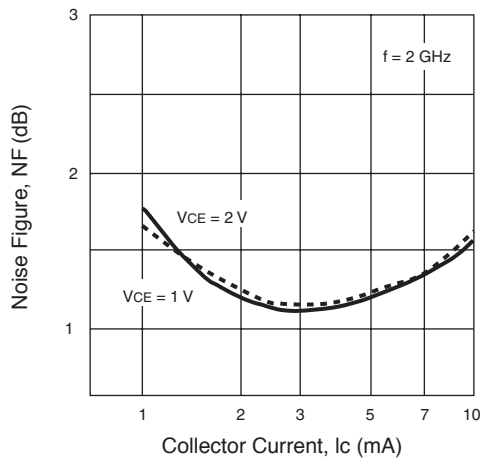

FEEDBACK CAPACITANCE vs. COLLECTOR TO BASE VOLTAGE

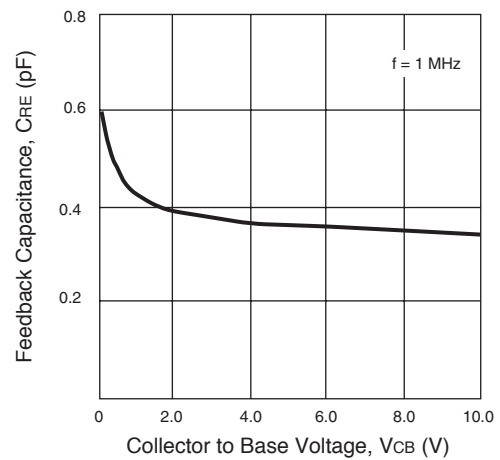

ORDERING INFORMATION

PART NUMBER	QUANTITY	PACKAGING
UPA808T-T1-A	3000	Tape & Reel

UPA808T

TYPICAL SCATTERING PARAMETERS (T_A = 25°C)

UPA808T(Q1)

V_{CE} = 1 V, I_C = 1 mA

FREQUENCY (GHz)	S ₁₁		S ₂₁		S ₁₂		S ₂₂		K	MAG ¹ (dB)
	MAG	ANG	MAG	ANG	MAG	ANG	MAG	ANG		
0.100	0.964	-7.10	3.204	169.70	0.026	83.50	0.993	-5.60	0.116	20.907
0.200	0.951	-15.70	3.104	164.00	0.052	78.20	0.979	-11.80	0.098	17.759
0.400	0.906	-31.00	2.978	149.60	0.099	66.80	0.932	-22.40	0.190	14.783
0.600	0.837	-45.10	2.814	136.50	0.134	57.70	0.869	-31.40	0.277	13.222
0.800	0.762	-57.80	2.606	125.10	0.160	50.40	0.806	-38.70	0.363	12.119
1.000	0.692	-68.70	2.378	115.50	0.178	44.60	0.750	-44.50	0.451	11.258
1.200	0.629	-78.50	2.190	106.90	0.190	40.40	0.702	-49.10	0.539	10.617
1.400	0.574	-87.50	2.018	99.40	0.199	37.10	0.663	-52.80	0.624	10.061
1.600	0.529	-95.40	1.860	93.00	0.205	34.70	0.632	-56.00	0.705	9.578
1.800	0.489	-103.20	1.743	87.30	0.210	33.10	0.608	-58.70	0.775	9.191
2.000	0.456	-110.30	1.629	81.90	0.214	32.00	0.587	-61.10	0.848	8.815
2.200	0.429	-117.70	1.534	77.00	0.216	31.10	0.572	-63.20	0.914	8.514
2.400	0.402	-124.80	1.468	72.50	0.218	31.10	0.556	-65.30	0.975	8.283
2.600	0.383	-131.80	1.402	68.30	0.220	31.50	0.542	-67.40	1.030	6.973
2.800	0.363	-139.90	1.347	64.10	0.225	31.10	0.532	-68.40	1.072	6.134
3.000	0.344	-147.70	1.306	60.40	0.227	31.70	0.521	-70.30	1.116	5.526

UPA808T(Q2)

V_{CE} = 1 V, I_C = 1 mA

FREQUENCY (GHz)	S ₁₁		S ₂₁		S ₁₂		S ₂₂		K	MAG ¹ (dB)
	MAG	ANG	MAG	ANG	MAG	ANG	MAG	ANG		
0.100	0.963	-7.00	3.233	169.80	0.027	83.30	0.991	-5.40	0.126	20.782
0.200	0.954	-16.20	3.200	164.10	0.050	79.10	0.981	-10.90	0.086	18.062
0.400	0.907	-32.50	3.084	149.60	0.096	67.20	0.937	-21.10	0.179	15.068
0.600	0.842	-47.90	2.930	136.20	0.132	57.20	0.875	-30.10	0.264	13.463
0.800	0.765	-62.60	2.736	124.00	0.160	48.70	0.807	-37.90	0.350	12.330
1.000	0.695	-75.80	2.514	113.40	0.179	41.60	0.743	-44.10	0.438	11.475
1.200	0.634	-87.90	2.324	103.70	0.193	36.10	0.685	-49.40	0.524	10.807
1.400	0.581	-99.50	2.142	95.20	0.201	31.50	0.636	-53.80	0.609	10.276
1.600	0.540	-110.20	1.975	87.50	0.207	27.70	0.595	-57.80	0.691	9.796
1.800	0.506	-120.70	1.840	80.70	0.212	24.70	0.561	-61.40	0.763	9.385
2.000	0.486	-130.10	1.707	74.40	0.214	22.30	0.533	-64.40	0.837	9.018
2.200	0.474	-139.30	1.598	68.60	0.215	20.30	0.511	-67.30	0.901	8.711
2.400	0.463	-147.30	1.516	63.20	0.215	19.20	0.491	-70.30	0.964	8.483
2.600	0.461	-154.50	1.434	58.30	0.219	18.60	0.468	-72.40	1.016	7.381
2.800	0.456	-161.30	1.370	53.40	0.218	17.40	0.459	-74.90	1.070	6.367
3.000	0.453	-167.60	1.318	48.90	0.219	17.30	0.445	-77.30	1.116	5.723

Note:

1. Gain Calculation:

$$\text{MAG} = \frac{|S_{21}|}{|S_{12}|} \left(K \pm \sqrt{K^2 - 1} \right). \text{ When } K \leq 1, \text{ MAG is undefined and MSG values are used. } \text{MSG} = \frac{|S_{21}|}{|S_{12}|}, K = \frac{1 + |\Delta|^2 - |S_{11}|^2 - |S_{22}|^2}{2 |S_{12} S_{21}|}, \Delta = S_{11} S_{22} - S_{21} S_{12}$$

MAG = Maximum Available Gain

MSG = Maximum Stable Gain

TYPICAL SCATTERING PARAMETERS (T_A = 25°C)

UPA808T(Q1)

V_{CE} = 2 V, I_C = 3 mA

FREQUENCY (GHz)	S ₁₁		S ₂₁		S ₁₂		S ₂₂		K	MAG ¹ (dB)
	MAG	ANG	MAG	ANG	MAG	ANG	MAG	ANG		
0.100	0.906	-10.80	8.655	167.00	0.023	79.00	0.973	-9.20	0.185	25.755
0.200	0.861	-23.80	8.210	157.00	0.041	74.40	0.933	-18.10	0.172	23.016
0.400	0.751	-45.10	7.280	138.70	0.073	63.10	0.818	-32.10	0.305	19.988
0.600	0.624	-62.80	6.278	124.00	0.093	56.00	0.704	-41.40	0.448	18.293
0.800	0.521	-76.70	5.345	112.90	0.107	52.10	0.616	-47.40	0.576	16.986
1.000	0.438	-88.00	4.587	104.30	0.118	50.10	0.553	-51.30	0.692	15.896
1.200	0.376	-97.20	4.003	97.40	0.128	49.70	0.507	-53.80	0.789	14.952
1.400	0.325	-105.80	3.541	91.30	0.137	49.50	0.476	-55.50	0.873	14.124
1.600	0.285	-113.30	3.173	86.20	0.146	49.70	0.454	-56.90	0.943	13.371
1.800	0.251	-120.50	2.884	81.70	0.156	50.20	0.439	-58.10	0.994	12.669
2.000	0.223	-127.50	2.640	77.50	0.166	50.80	0.430	-59.20	1.035	10.869
2.200	0.202	-134.70	2.436	73.60	0.176	51.00	0.422	-60.10	1.069	9.807
2.400	0.181	-141.70	2.280	70.00	0.187	51.50	0.417	-61.10	1.089	9.043
2.600	0.164	-147.70	2.135	66.60	0.198	52.00	0.412	-62.40	1.109	8.315
2.800	0.150	-156.90	2.016	63.20	0.210	51.50	0.408	-63.00	1.119	7.727
3.000	0.138	-165.00	1.919	60.20	0.221	51.50	0.405	-64.30	1.126	7.229

UPA808T(Q2)

V_{CE} = 2 V, I_C = 3 mA

FREQUENCY (GHz)	S ₁₁		S ₂₁		S ₁₂		S ₂₂		K	MAG ¹ (dB)
	MAG	ANG	MAG	ANG	MAG	ANG	MAG	ANG		
0.100	0.900	-10.70	8.679	167.40	0.019	83.20	0.973	-8.50	0.116	26.597
0.200	0.870	-23.40	8.281	157.90	0.038	76.10	0.941	-16.60	0.144	23.383
0.400	0.770	-45.30	7.468	139.70	0.068	63.00	0.834	-30.00	0.287	20.407
0.600	0.650	-64.40	6.557	124.40	0.089	54.80	0.719	-39.50	0.425	18.673
0.800	0.544	-80.70	5.655	112.30	0.103	49.30	0.622	-46.00	0.556	17.396
1.000	0.463	-94.70	4.888	102.60	0.114	46.40	0.549	-50.50	0.667	16.322
1.200	0.403	-107.20	4.276	94.60	0.123	44.50	0.492	-53.70	0.767	15.411
1.400	0.357	-119.00	3.784	87.60	0.131	43.30	0.449	-56.10	0.856	14.607
1.600	0.325	-130.00	3.387	81.60	0.139	42.70	0.416	-58.30	0.929	13.868
1.800	0.304	-140.10	3.073	76.10	0.148	42.20	0.391	-60.00	0.984	13.173
2.000	0.291	-149.30	2.804	71.10	0.157	41.70	0.371	-61.60	1.030	10.341
2.200	0.285	-157.40	2.581	66.30	0.165	41.30	0.356	-63.10	1.069	9.807
2.400	0.280	-164.30	2.408	61.90	0.174	41.10	0.343	-64.70	1.095	9.532
2.600	0.283	-169.90	2.242	57.80	0.186	40.80	0.325	-65.80	1.112	8.774
2.800	0.279	-175.10	2.112	53.70	0.194	39.80	0.320	-66.80	1.134	8.147
3.000	0.280	-178.70	2.002	49.80	0.204	39.40	0.313	-67.70	1.142	7.629

Note:

1. Gain Calculation:

$$\text{MAG} = \frac{|S_{21}|}{|S_{12}|} \left(K \pm \sqrt{K^2 - 1} \right). \text{ When } K \leq 1, \text{ MAG is undefined and MSG values are used. } \text{MSG} = \frac{|S_{21}|}{|S_{12}|}, K = \frac{1 + |\Delta|^2 - |S_{11}|^2 - |S_{22}|^2}{2 |S_{12} S_{21}|}, \Delta = S_{11} S_{22} - S_{21} S_{12}$$

MAG = Maximum Available Gain

MSG = Maximum Stable Gain

UPA808T

TYPICAL SCATTERING PARAMETERS (TA = 25°C)

UPA808T(Q1)

VCE = 2 V, IC = 5 mA

FREQUENCY (GHz)	S11		S21		S12		S22		K	MAG ¹ (dB)
	MAG	ANG	MAG	ANG	MAG	ANG	MAG	ANG		
0.100	0.838	-15.70	13.071	163.70	0.022	72.70	0.951	-12.50	0.268	27.739
0.200	0.773	-31.30	12.042	150.90	0.038	71.70	0.881	-23.70	0.237	25.009
0.400	0.617	-57.00	9.858	129.90	0.064	60.90	0.715	-39.10	0.427	21.876
0.600	0.480	-76.00	7.906	115.30	0.080	56.50	0.585	-47.50	0.596	19.949
0.800	0.383	-90.10	6.425	105.20	0.093	55.30	0.500	-51.90	0.731	18.394
1.000	0.314	-101.70	5.360	97.70	0.105	55.30	0.445	-54.40	0.836	17.080
1.200	0.264	-111.20	4.590	91.80	0.116	56.00	0.408	-55.70	0.919	15.974
1.400	0.223	-120.00	4.010	86.50	0.128	56.50	0.386	-56.50	0.979	14.959
1.600	0.191	-128.40	3.565	82.00	0.141	56.80	0.372	-57.20	1.019	13.176
1.800	0.166	-136.40	3.214	78.00	0.154	57.00	0.365	-57.80	1.047	11.870
2.000	0.144	-144.50	2.927	74.30	0.166	57.10	0.360	-58.40	1.073	10.810
2.200	0.129	-152.60	2.689	70.80	0.179	56.90	0.358	-59.20	1.088	9.959
2.400	0.114	-160.70	2.504	67.50	0.193	56.80	0.357	-60.10	1.093	9.269
2.600	0.101	-168.00	2.337	64.40	0.206	56.90	0.356	-61.30	1.103	8.594
2.800	0.094	-178.60	2.194	61.40	0.220	55.80	0.356	-62.00	1.105	8.020
3.000	0.088	171.70	2.078	58.60	0.233	55.30	0.356	-63.30	1.106	7.523

UPA808T(Q2)

VCE = 2 V, IC = 5 mA

FREQUENCY (GHz)	S11		S21		S12		S22		K	MAG ¹ (dB)
	MAG	ANG	MAG	ANG	MAG	ANG	MAG	ANG		
0.100	0.840	-15.00	13.056	164.50	0.020	80.40	0.957	-11.50	0.158	28.148
0.200	0.786	-30.50	12.136	152.10	0.036	72.30	0.894	-21.80	0.224	25.278
0.400	0.643	-57.00	10.174	131.10	0.061	60.90	0.736	-37.00	0.396	22.222
0.600	0.508	-78.00	8.314	115.40	0.077	54.80	0.600	-45.80	0.567	20.333
0.800	0.410	-94.80	6.820	104.30	0.089	52.10	0.503	-51.00	0.705	18.844
1.000	0.343	-109.70	5.711	95.80	0.100	50.80	0.437	-54.00	0.814	17.567
1.200	0.299	-122.50	4.901	88.70	0.111	50.40	0.388	-56.00	0.897	16.450
1.400	0.266	-134.90	4.275	82.60	0.121	50.10	0.354	-57.50	0.967	15.482
1.600	0.247	-146.20	3.796	77.30	0.132	49.70	0.328	-58.90	1.015	13.833
1.800	0.235	-156.00	3.418	72.50	0.144	49.30	0.309	-60.10	1.047	12.429
2.000	0.230	-165.10	3.106	68.00	0.154	48.70	0.294	-61.10	1.079	11.332
2.200	0.229	-171.90	2.849	63.70	0.166	47.80	0.284	-62.20	1.094	10.473
2.400	0.228	-177.70	2.648	59.60	0.178	47.20	0.275	-63.40	1.104	9.761
2.600	0.232	178.40	2.454	55.70	0.192	46.20	0.259	-64.20	1.114	9.015
2.800	0.230	174.30	2.308	51.90	0.203	44.80	0.258	-64.60	1.120	8.451
3.000	0.232	171.50	2.181	48.20	0.215	43.80	0.252	-65.20	1.123	7.933

Note:

1. Gain Calculation:

$$MAG = \frac{|S_{21}|}{|S_{12}|} \left(K \pm \sqrt{K^2 - 1} \right). \text{ When } K \leq 1, \text{ MAG is undefined and MSG values are used. } MSG = \frac{|S_{21}|}{|S_{12}|}, K = \frac{1 + |\Delta|^2 - |S_{11}|^2 - |S_{22}|^2}{2 |S_{12} S_{21}|}, \Delta = S_{11} S_{22} - S_{21} S_{12}$$

MAG = Maximum Available Gain

MSG = Maximum Stable Gain

TYPICAL SCATTERING PARAMETERS (T_A = 25°C)

UPA808T(Q1)

V_{CE} = 3 V, I_C = 3 mA

FREQUENCY (GHz)	S ₁₁		S ₂₁		S ₁₂		S ₂₂		K	MAG ¹ (dB)
	MAG	ANG	MAG	ANG	MAG	ANG	MAG	ANG		
0.100	0.912	-10.30	8.671	167.30	0.019	86.00	0.969	-8.60	0.080	26.593
0.200	0.875	-22.40	8.248	157.70	0.039	73.60	0.932	-16.90	0.200	23.253
0.400	0.769	-42.80	7.360	139.80	0.068	62.90	0.825	-30.10	0.319	20.344
0.600	0.643	-59.60	6.398	125.30	0.088	56.40	0.717	-39.00	0.452	18.616
0.800	0.538	-72.90	5.475	114.10	0.102	52.60	0.632	-44.80	0.577	17.298
1.000	0.453	-83.60	4.713	105.60	0.113	50.80	0.571	-48.40	0.688	16.202
1.200	0.386	-92.40	4.122	98.60	0.122	50.40	0.526	-50.80	0.787	15.287
1.400	0.333	-100.20	3.650	92.50	0.131	50.20	0.495	-52.50	0.870	14.450
1.600	0.290	-107.20	3.273	87.40	0.140	50.70	0.475	-53.80	0.936	13.688
1.800	0.253	-114.00	2.975	82.80	0.150	51.00	0.459	-54.90	0.988	12.974
2.000	0.223	-120.20	2.721	78.60	0.159	51.60	0.450	-55.90	1.033	11.225
2.200	0.200	-126.90	2.511	74.70	0.169	51.80	0.443	-56.90	1.064	10.174
2.400	0.176	-132.70	2.349	71.10	0.180	52.30	0.438	-57.90	1.084	9.389
2.600	0.158	-138.40	2.200	67.80	0.190	53.00	0.434	-59.10	1.104	8.669
2.800	0.141	-146.80	2.075	64.50	0.202	52.30	0.430	-59.70	1.114	8.063
3.000	0.128	-155.20	1.973	61.50	0.213	52.80	0.428	-60.90	1.118	7.574

UPA808T(Q2)

V_{CE} = 3 V, I_C = 3 mA

FREQUENCY (GHz)	S ₁₁		S ₂₁		S ₁₂		S ₂₂		K	MAG ¹ (dB)
	MAG	ANG	MAG	ANG	MAG	ANG	MAG	ANG		
0.100	0.909	-10.10	8.683	167.70	0.019	82.00	0.970	-7.70	0.152	26.599
0.200	0.882	-22.00	8.324	158.60	0.035	74.20	0.940	-15.40	0.187	23.763
0.400	0.786	-43.00	7.550	140.80	0.064	63.40	0.841	-27.90	0.299	20.718
0.600	0.668	-61.10	6.677	125.80	0.084	55.40	0.733	-36.90	0.431	19.003
0.800	0.561	-76.60	5.794	113.70	0.098	50.20	0.641	-43.10	0.555	17.718
1.000	0.476	-90.20	5.027	104.10	0.108	47.10	0.569	-47.40	0.666	16.679
1.200	0.412	-102.20	4.411	96.00	0.117	45.50	0.514	-50.40	0.763	15.764
1.400	0.363	-113.60	3.913	88.90	0.126	44.10	0.471	-52.60	0.848	14.921
1.600	0.326	-124.10	3.505	82.80	0.133	43.50	0.439	-54.60	0.925	14.208
1.800	0.301	-134.10	3.183	77.40	0.142	43.10	0.415	-56.30	0.977	13.505
2.000	0.286	-143.00	2.904	72.30	0.150	42.70	0.396	-57.70	1.025	11.892
2.200	0.278	-151.60	2.671	67.60	0.158	42.30	0.380	-59.10	1.065	10.726
2.400	0.271	-158.60	2.492	63.20	0.167	42.00	0.367	-60.60	1.090	9.904
2.600	0.273	-164.50	2.318	59.00	0.178	41.70	0.350	-61.70	1.110	9.125
2.800	0.268	-169.50	2.185	54.90	0.187	40.80	0.346	-62.60	1.126	8.521
3.000	0.268	-173.50	2.069	51.10	0.196	40.60	0.339	-63.50	1.138	7.979

Note:

1. Gain Calculation:

$$\text{MAG} = \frac{|S_{21}|}{|S_{12}|} \left(K \pm \sqrt{K^2 - 1} \right). \text{ When } K \leq 1, \text{ MAG is undefined and MSG values are used. } \text{MSG} = \frac{|S_{21}|}{|S_{12}|}, K = \frac{1 + |\Delta|^2 - |S_{11}|^2 - |S_{22}|^2}{2 |S_{12} S_{21}|}, \Delta = S_{11} S_{22} - S_{21} S_{12}$$

MAG = Maximum Available Gain

MSG = Maximum Stable Gain

NONLINEAR MODEL

BJT NONLINEAR MODEL PARAMETERS ⁽¹⁾

Parameters	Q1, Q2	Parameters	Q1, Q2
IS	8e-17	MJC	0.53
BF	128	XCJC	0.27
NF	1	CJS	0
VAF	17	VJS	0.75
IKF	0.18	MJS	0
ISE	3.3e-15	FC	0.37
NE	1.48	TF	6e-12
BR	9.05	XTF	11.9
NR	1.05	VTF	9.55
VAR	4.3	ITF	1.78
IKR	0.009	PTF	69.1
ISC	4e-15	TR	1e-9
NC	1.5	EG	1.11
RE	0.8	XTB	0
RB	11.1	XTI	3
RBM	2.46	KF	0
IRB	0.017	AF	1
RC	7.5		
CJE	0.415e-12		
VJE	0.68		
MJE	0.53		
CJC	0.102e-12		
VJC	0.29		

(1) Gummel-Poon Model

Note:

This nonlinear model utilized the latest data available.
See our Design Parameter Library at www.cel.com for this data.

UNITS

Parameter	Units
time	seconds
capacitance	farads
inductance	henries
resistance	ohms
voltage	volts
current	amps

MODEL RANGE

Frequency: 0.1 to 3.0 GHz
Bias: $V_{CE} = 0.5 \text{ V to } 2 \text{ V}$, $I_c = 0.5 \text{ mA to } 10 \text{ mA}$
Date: 10/98

NONLINEAR MODEL

SCHEMATIC

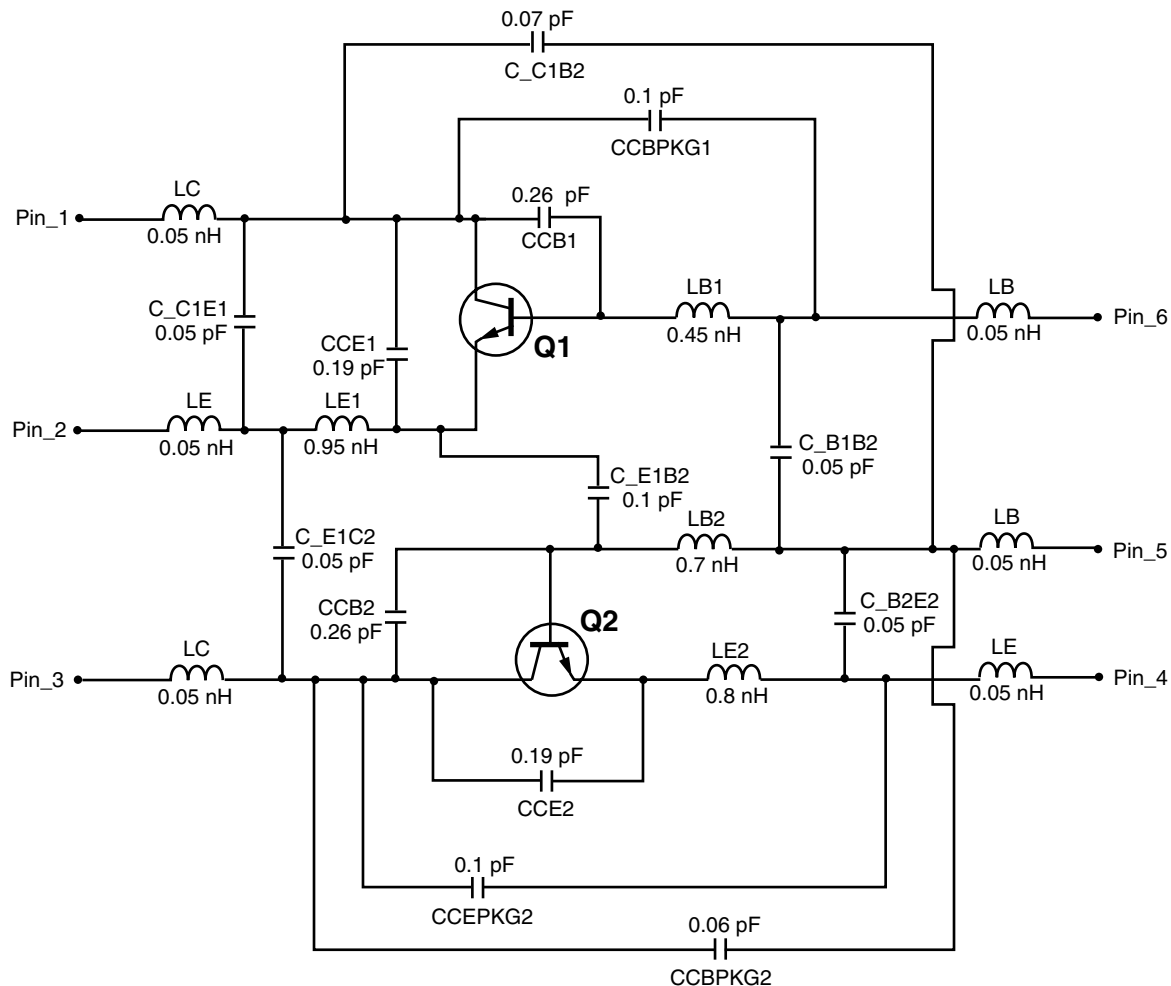

MODEL RANGE

Frequency: 0.1 to 3.0 GHz
 Bias: $V_{CE} = 0.5 \text{ V to } 2 \text{ V}$, $I_C = 0.5 \text{ mA to } 10 \text{ mA}$
 Date: 10/98

Life Support Applications

These NEC products are not intended for use in life support devices, appliances, or systems where the malfunction of these products can reasonably be expected to result in personal injury. The customers of CEL using or selling these products for use in such applications do so at their own risk and agree to fully indemnify CEL for all damages resulting from such improper use or sale.

EXCLUSIVE NORTH AMERICAN AGENT FOR **NEC** RF, MICROWAVE & OPTOELECTRONIC SEMICONDUCTORS

CEL CALIFORNIA EASTERN LABORATORIES ¥ Headquarters ¥ 4590 Patrick Henry Drive ¥ Santa Clara, CA 95054-1817 ¥ (408) 988-3500 ¥ Telex 34-6393 ¥ FAX (408) 988-02
 24-Hour Fax-On-Demand: 800-390-3232 (U.S. and Canada only) ¥ Internet: <http://WWW.CEL.COM>

DATA SUBJECT TO CHANGE WITHOUT NOTICE

□□□

8/99

Subject: Compliance with EU Directives

CEL certifies, to its knowledge, that semiconductor and laser products detailed below are compliant with the requirements of European Union (EU) Directive 2002/95/EC Restriction on Use of Hazardous Substances in electrical and electronic equipment (RoHS) and the requirements of EU Directive 2003/11/EC Restriction on Penta and Octa BDE.

CEL Pb-free products have the same base part number with a suffix added. The suffix –A indicates that the device is Pb-free. The –AZ suffix is used to designate devices containing Pb which are exempted from the requirement of RoHS directive (*). In all cases the devices have Pb-free terminals. All devices with these suffixes meet the requirements of the RoHS directive.

This status is based on CEL’s understanding of the EU Directives and knowledge of the materials that go into its products as of the date of disclosure of this information.

Restricted Substance per RoHS	Concentration Limit per RoHS (values are not yet fixed)	Concentration contained in CEL devices	
		-A	-AZ
Lead (Pb)	< 1000 PPM	Not Detected	(*)
Mercury	< 1000 PPM	Not Detected	
Cadmium	< 100 PPM	Not Detected	
Hexavalent Chromium	< 1000 PPM	Not Detected	
PBB	< 1000 PPM	Not Detected	
PBDE	< 1000 PPM	Not Detected	

If you should have any additional questions regarding our devices and compliance to environmental standards, please do not hesitate to contact your local representative.

Important Information and Disclaimer: Information provided by CEL on its website or in other communications concerning the substance content of its products represents knowledge and belief as of the date that it is provided. CEL bases its knowledge and belief on information provided by third parties and makes no representation or warranty as to the accuracy of such information. Efforts are underway to better integrate information from third parties. CEL has taken and continues to take reasonable steps to provide representative and accurate information but may not have conducted destructive testing or chemical analysis on incoming materials and chemicals. CEL and CEL suppliers consider certain information to be proprietary, and thus CAS numbers and other limited information may not be available for release.

In no event shall CEL's liability arising out of such information exceed the total purchase price of the CEL part(s) at issue sold by CEL to customer on an annual basis.

See CEL Terms and Conditions for additional clarification of warranties and liability.