

## High Power Density 1W Laser Diode

---

### Description

The SLD323V is a high power, gain-guided laser diode produced by MOCVD method\*1. Compared to the SLD300 Series, this laser diode has a high brightness output with a doubled optical density which can be achieved by QW-SCH structure\*2.

\*1 MOCVD: Metal Organic Chemical Vapor Deposition

\*2 QW-SCH: Quantum Well Separate Confinement Heterostructure

### Features

- High power  
Recommended optical power output:  $P_o = 1.0W$
- Low operating current:  $I_{op} = 1.4A$  ( $P_o = 1.0W$ )

### Applications

- Solid state laser excitation
- Medical use
- Material processes
- Measurement

### Structure

GaAlAs quantum well structure laser diode

### Absolute Maximum Ratings ( $T_c = 25^\circ C$ )

• Optical power output	$P_o$		1.1	W
• Reverse voltage	$V_R$	LD	2	V
		PD	15	V
• Operating temperature ( $T_c$ )	$T_{opr}$		-10 to +30	$^\circ C$
• Storage temperature	$T_{stg}$		-40 to +85	$^\circ C$

### Pin Configuration

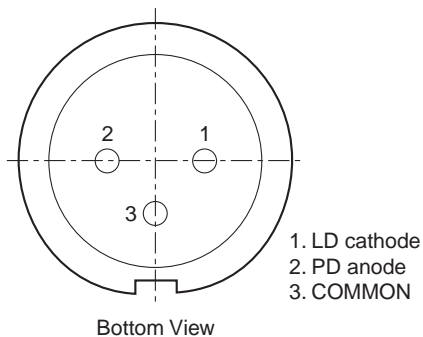

Sony reserves the right to change products and specifications without prior notice. This information does not convey any license by any implication or otherwise under any patents or other right. Application circuits shown, if any, are typical examples illustrating the operation of the devices. Sony cannot assume responsibility for any problems arising out of the use of these circuits.

**Electrical and Optical Characteristics**

(T<sub>c</sub>: case temperature, T<sub>c</sub> = 25°C)

Item	Symbol	Conditions	Min.	Typ.	Max.	Unit	
Threshold current	I <sub>th</sub>			0.3	0.5	A	
Operating current	I <sub>op</sub>	P <sub>o</sub> = 1.0W		1.4	2.0	A	
Operating voltage	V <sub>op</sub>	P <sub>o</sub> = 1.0W		2.1	3.0	V	
Wavelength*1	λ <sub>p</sub>	P <sub>o</sub> = 1.0W	790		840	nm	
Monitor current	I <sub>mon</sub>	P <sub>o</sub> = 1.0W V <sub>R</sub> = 10V	0.3	1.5	6.0	mA	
Radiation angle (F. W. H. M.*)	Perpendicular	θ <sub>⊥</sub>	P <sub>o</sub> = 1.0W	20	30	40	degree
	Parallel			θ <sub>//</sub>	4	9	17
Positional accuracy	Position	ΔX, ΔY	P <sub>o</sub> = 1.0W			±50	μm
	Angle	Δφ <sub>⊥</sub>				±3	degree
Differential efficiency	η <sub>D</sub>	P <sub>o</sub> = 1.0W	0.5	0.9		W/A	

\* F. W. H. M. : Full Width at Half Maximum

**\*1 Wavelength Selection Classification**

Type	Wavelength (nm)
SLD323V-1	795 ± 5
SLD323V-2	810 ± 10
SLD323V-3	830 ± 10

Type	Wavelength (nm)
SLD323V-21	798 ± 3
SLD323V-24	807 ± 3
SLD323V-25	810 ± 3

**Handling Precautions**

Eye protection against laser beams

The optical output of laser diodes ranges from several mW to 3W. However the optical power density of the laser beam at the diode chip reaches 1MW/cm<sup>2</sup>. Unlike gas lasers, since laser diode beams are divergent, uncollimated laser diode beams are fairly safe at a laser diode. For observing laser beams, ALWAYS use safety goggles that block infrared rays. Usage of IR scopes, IR cameras and fluorescent plates is also recommended for monitoring laser beams safely.

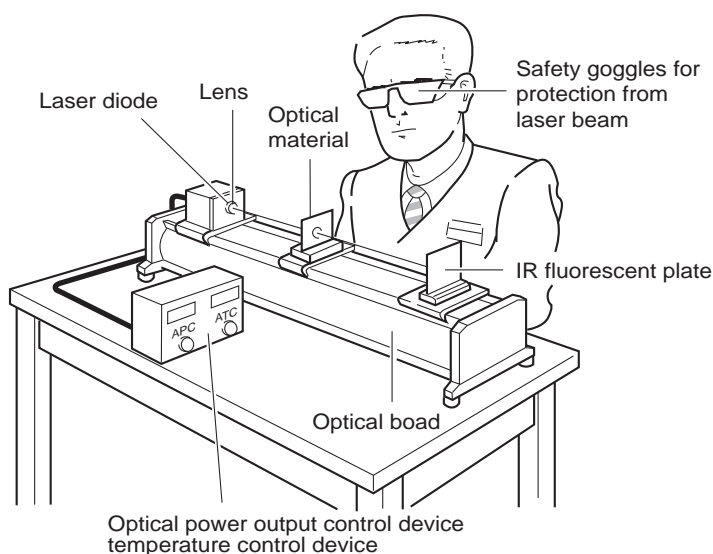

Example of Representative Characteristics

Optical power output vs. Forward current characteristics

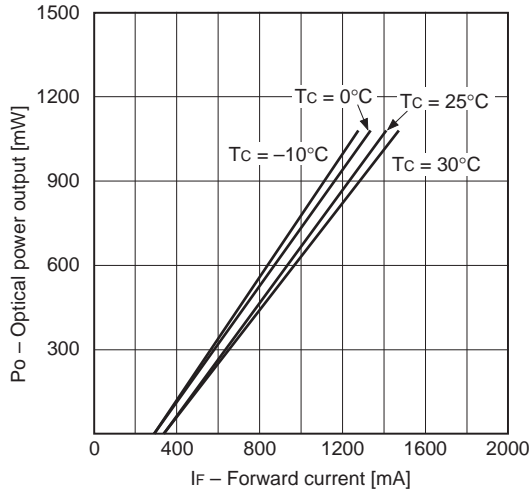

Optical power output vs. Monitor current characteristics

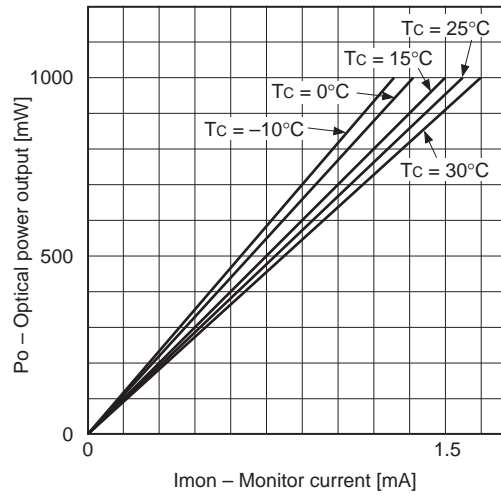

Threshold current vs. Temperature characteristics

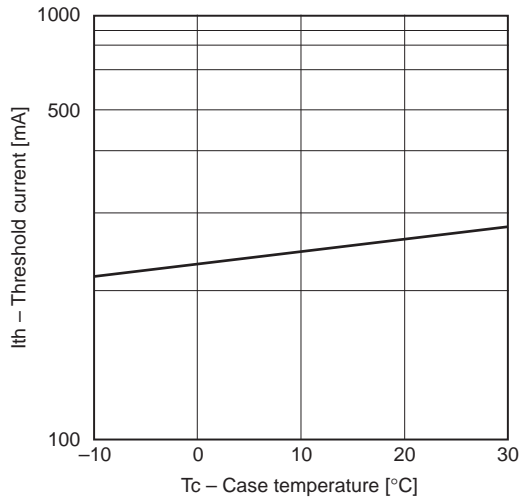

Power dependence of far field pattern (Parallel to junction)

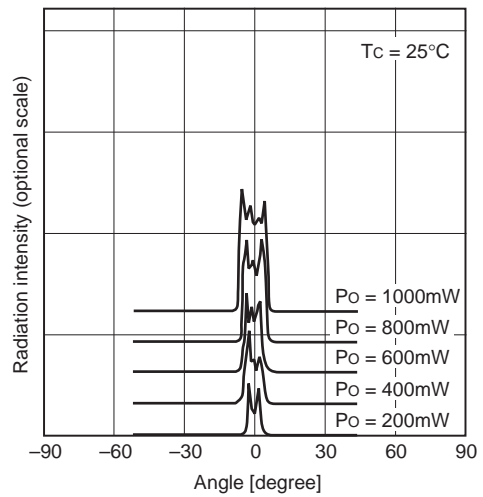

Power dependence of far field pattern (Perpendicular to junction)

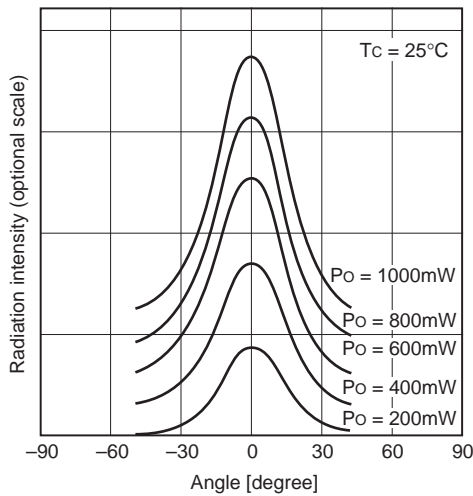

Temperature dependence of far field pattern (Parallel to junction)

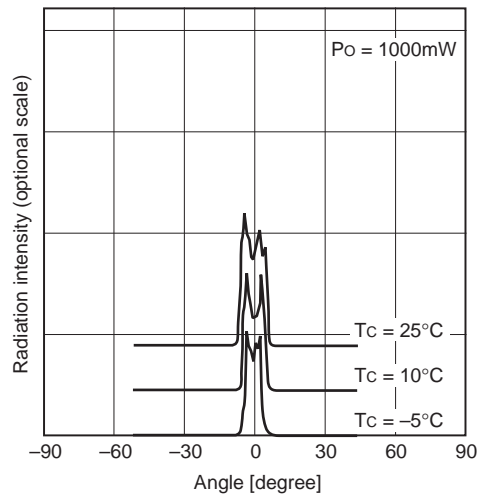

Temperature dependence of far field pattern  
(Perpendicular to junction)

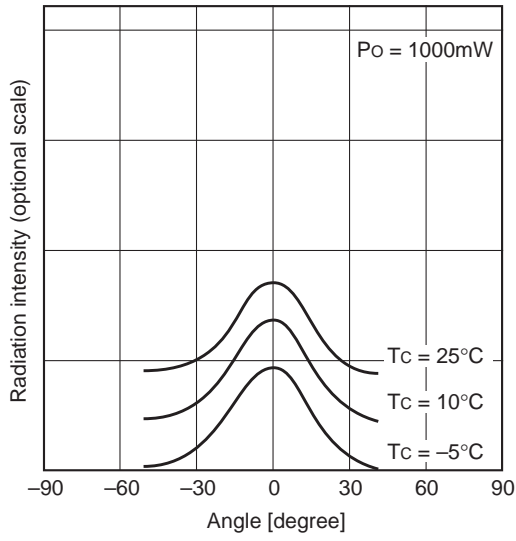

Dependence of wavelength

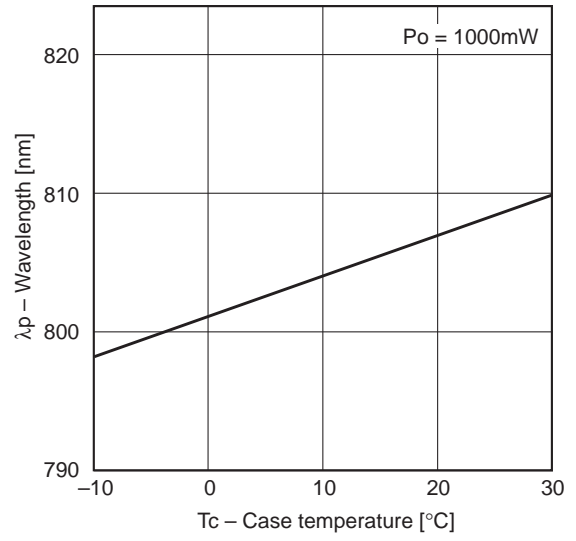

Differential efficiency vs. Temperature characteristics

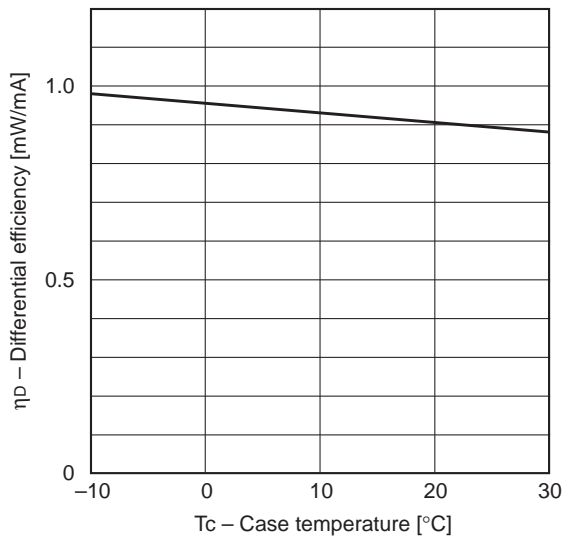

Power dependence of spectrum

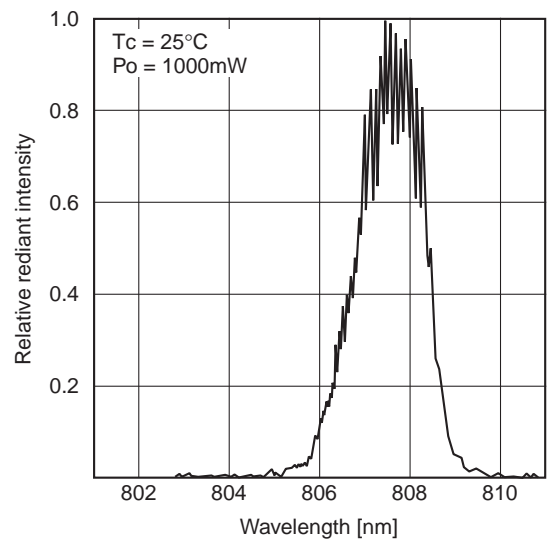
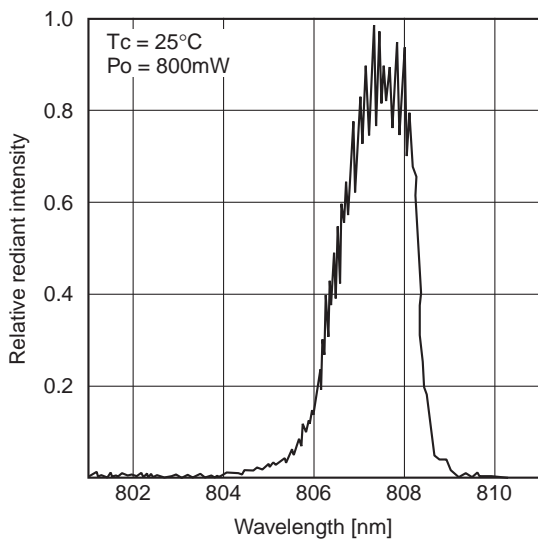
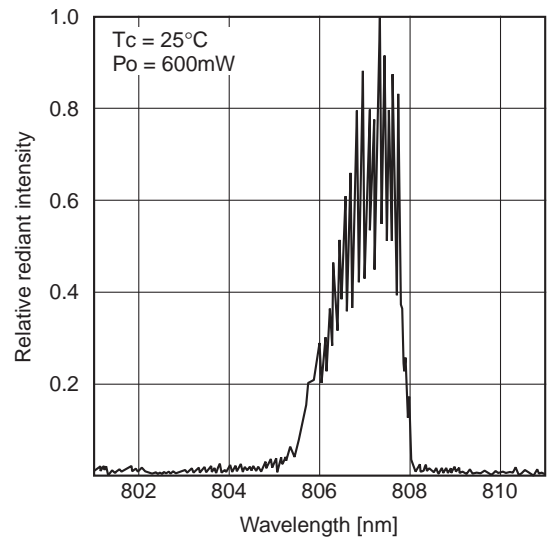
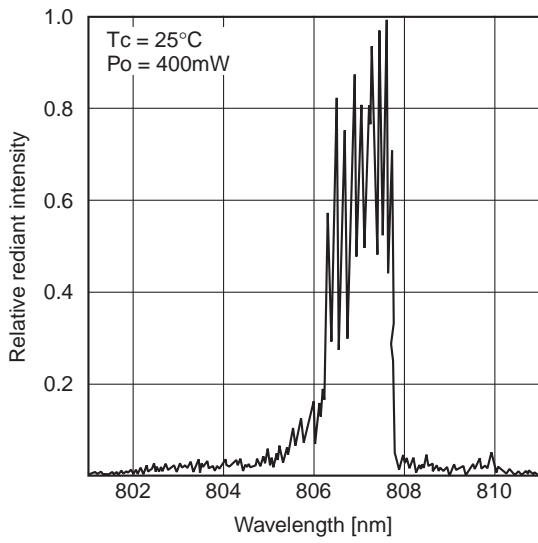

Temperature dependence of spectrum ( $P_o = 1.0W$ )

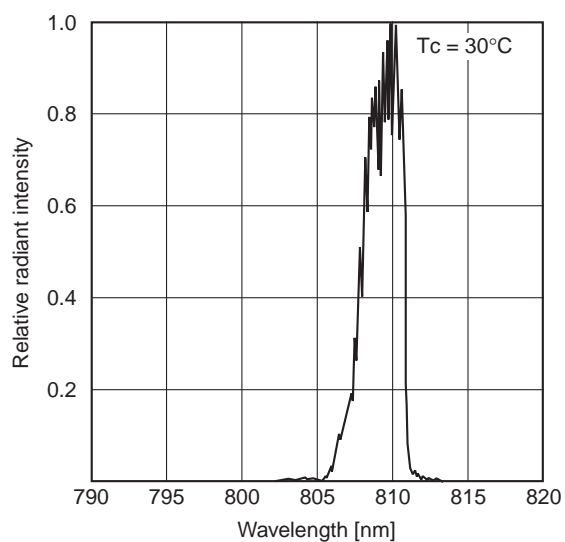
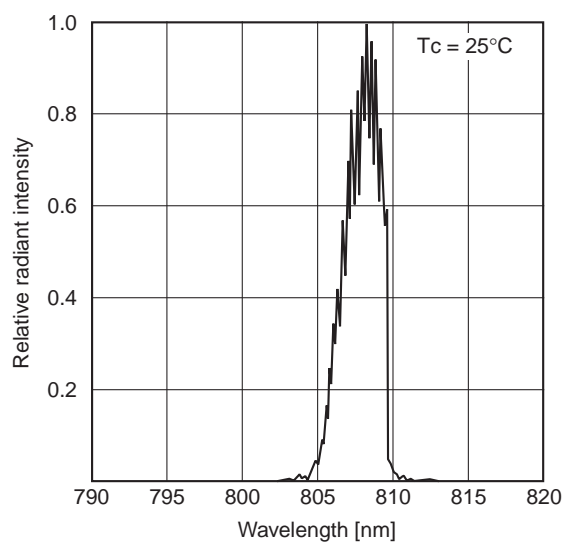
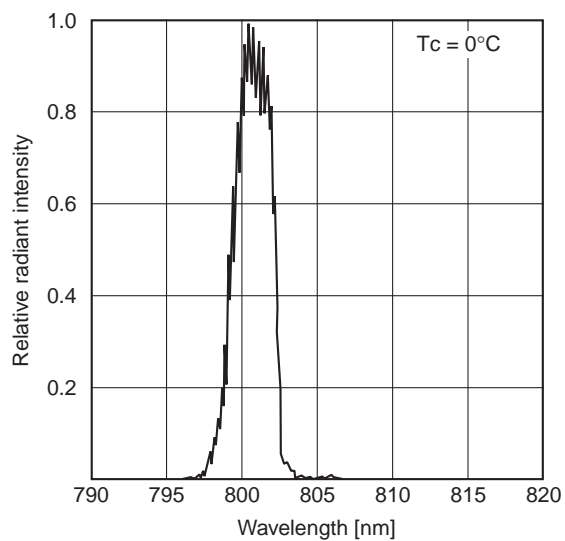
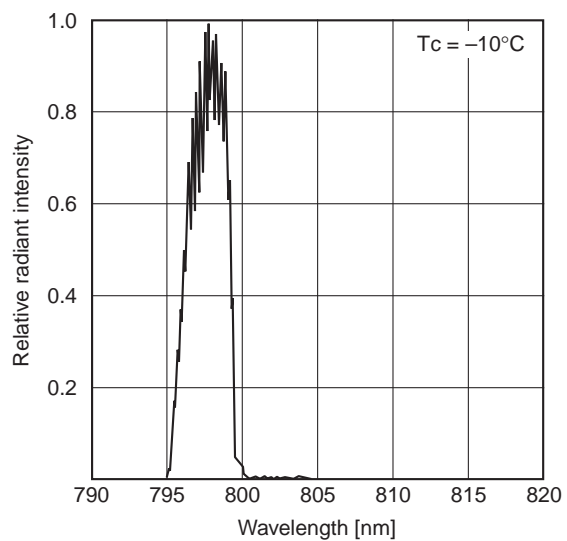

Package Outline

Unit: mm

M-248 (LO-11)

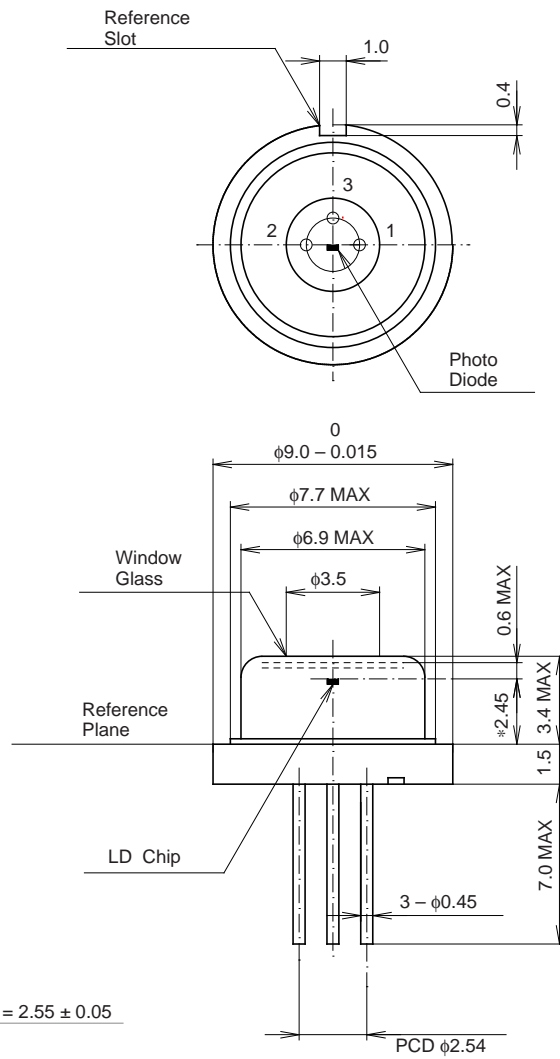

\*Optical Distance =  $2.55 \pm 0.05$

SONY CODE	M-248
EIAJ CODE	_____
JEDEC CODE	_____

PACKAGE WEIGHT	1.2g
----------------	------