

Features

- Plastic Package has Underwriters Laboratory Flammability Classification 94V-0
- Metal silicon junction, majority carrier conduction
- Guard ring for overvoltage protection
- Low power loss, high efficiency
- High current capability, Low forward voltage drop
- High surge capability
- For use in low voltage, high frequency inverters, free wheeling, and polarity protection applications
- Dual rectifier construction
- High temperature soldering guaranteed : 250°C/10 seconds, 0.25" (6.35mm) from case

Mechanical Data

- Case : JEDEC ITO-220 molded plastic body
- Terminals : Lead solderable per MIL-STD-750, Method 2026
- Polarity : As marked. No suffix indicates Common Cathode, suffix "A" indicates Common Anode
- Mounting Position : Any
- Weight : 0.08 ounce, 2.24 grams

ITO-220

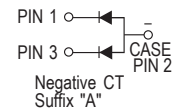
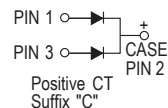
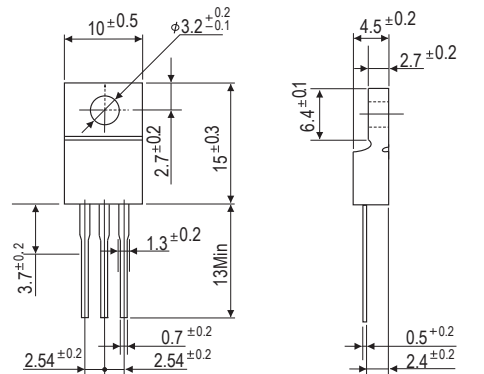

Dimensions in inches and (millimeters)

Maximum Ratings and Electrical Characteristics

(Ratings at 25°C ambient temperature unless otherwise specified, single phase, half wave, resistive or inductive load. For capacitive load, derate by 20%)

	Symbols	SBP1535	SBP1545	SBP1550	SBP1560	Units
Maximum repetitive peak reverse voltage	V_{RRM}	35	45	50	60	Volts
Maximum RMS voltage	V_{RMS}	25	32	35	42	Volts
Maximum DC blocking voltage	V_{DC}	35	45	50	60	Volts
Maximum average forward rectified current at $T_c=105^\circ\text{C}$ per diode/per device	$I_{(AV)}$	7.5 15.0				Amps Amps
Repetitive peak forward current(square wavr, 20KHZ) at $T_c=105^\circ\text{C}$ per diode	I_{FRM}	15.0				Amps
Peak forward surge current 8.3ms single half sine-wave superimposed on rated load (JEDEC method)	I_{FSM}	150.0				Amps
Maximum instantaneous forward voltage at 7.5A (Note 1)	V_F	0.65		0.75		Volts
Maximum instantaneous reverse current at rated DC blocking voltage (Note1)	$T_A=25^\circ\text{C}$	1.0				mA
	$T_A=125^\circ\text{C}$	15		50		
Typical thermal resistance (Note 2)	$R_{\theta JC}$	2.5				°C/W
Operating junction temperature range	T_J	-65 to +150				°C
Storage temperature range	T_{STG}	-65 to +175				°C

Notes:

- (1) Pulse test: 300µS pulse width, 1% duty cycle
- (2) Thermal resistance from junction to case



RATINGS AND CHARACTERISTIC CURVES SBP1535 THRU SBP1560

FIG.1-FORWARD CURRENT DERATING CURVE

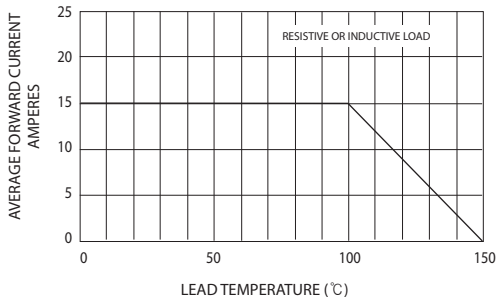

FIG.2-MAXIMUM NON-REPETITIVE PEAK FORWARD SURGE CURRENT

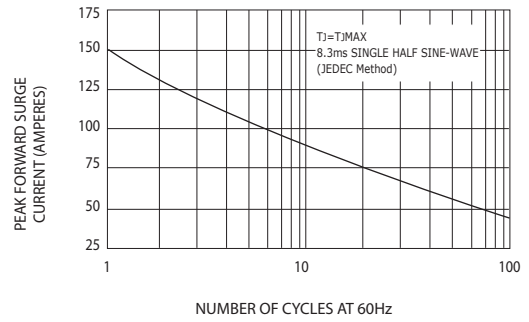

FIG.3-TYPICAL INSTANTANEOUS FORWARD CHARACTERISTICS

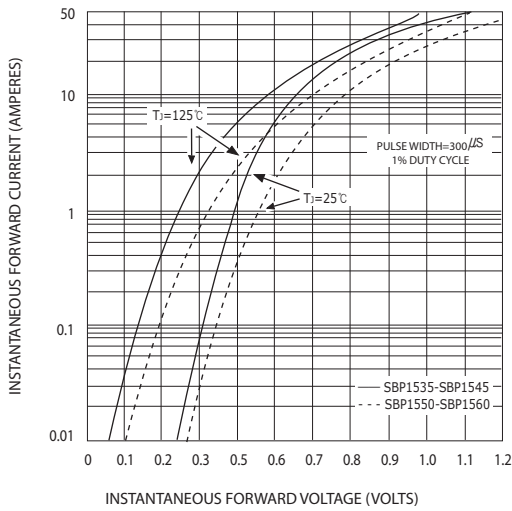

FIG.4-TYPICAL REVERSE CHARACTERISTICS

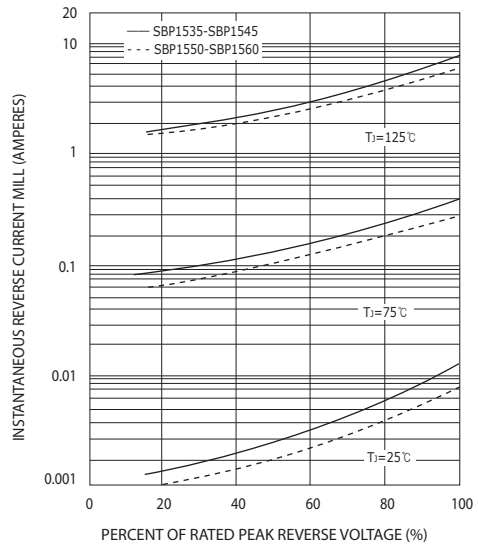

FIG.5-TYPICAL JUNCTION CAPACITANCE

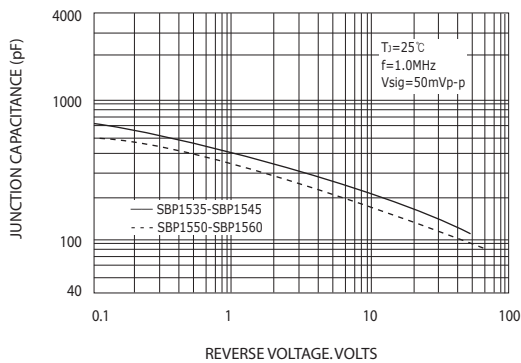

FIG.6-TYPICAL TRANSIENT THERMAL IMPEDANCE

