

Typical Applications

- TDMA/AMPS Cellular Systems
- CDMA/AMPS Cellular Systems
- PCS Systems
- Portable Battery-Powered Equipment

Product Description

The RF2643 is a complete upconverter, dual-power amplifier driver and attenuator designed for Cellular and PCS systems. It is designed to upconvert and amplify RF signals while providing 22dB of linear gain control range. It features digital control for the mixer and drivers. The device features balanced IF inputs, single-ended LO input and dual RF output for Cellular and PCS Systems respectively. The IC is manufactured on an advanced Silicon Bi-CMOS process and packaged in a 20-pin, 4mmx4mm, leadless chip carrier with an exposed die flag.

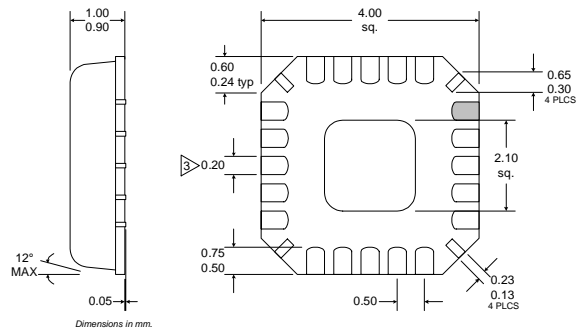

- NOTES:**
- 1 Shaded lead is Pin 1.
  - 2 Pin 1 identifier must exist on top surface of package by identification mark or feature on the package body. Exact shape and size is optional.
  - 3 Dimension applies to plated terminal: to be measured between 0.02 mm and 0.25 mm from terminal end.
  - 4 Package Warpage: 0.05 mm max.
  - 5 Die Thickness Allowable: 0.305 mm max.

**6**  
**MIXERS**

Optimum Technology Matching® Applied

- |  |                                   |                                      |
|--|-----------------------------------|--------------------------------------|
| <input type="checkbox"/> Si BJT                | <input type="checkbox"/> GaAs HBT | <input type="checkbox"/> GaAs MESFET |
| <input checked="" type="checkbox"/> Si Bi-CMOS | <input type="checkbox"/> SiGe HBT | <input type="checkbox"/> Si CMOS     |

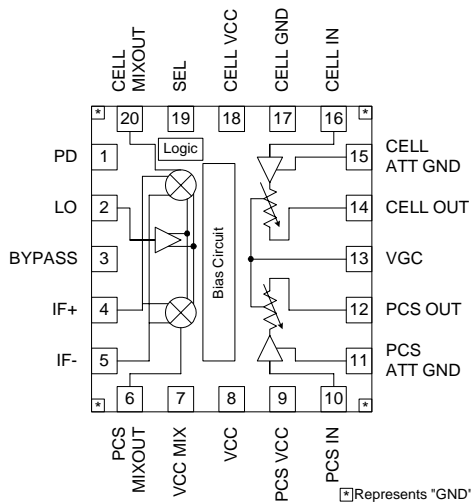

Functional Block Diagram

Package Style: LCC, 20-Pin, 4 x 4

Features

- Single Supply 3.0V Operation
- Power Down Control
- Gain Control Range of 22dB
- Driver Amplifier Select Pin (RF Output Select)
- High Linearity in Mixer and Driver Amp

Ordering Information

- |             |   |
|-------------|---|
| RF2643      | 3V Dual-Band Upconverter and Driver Amplifier |
| RF2643 PCBA | Fully Assembled Evaluation Board              |

RF Micro Devices, Inc.  
7628 Thorndike Road  
Greensboro, NC 27409, USA

Tel (336) 664 1233  
Fax (336) 664 0454  
<http://www.rfmd.com>

### Absolute Maximum Ratings

| Parameter                     | Rating       | Unit            |
|-------------------------------|--------------|-----------------|
| Supply Voltage                | -0.5 to +3.6 | V <sub>DC</sub> |
| Input RF Power                | +3           | dBm             |
| Operating Ambient Temperature | -30 to +80   | °C              |
| Storage Temperature           | -30 to +150  | °C              |



**Caution!** ESD sensitive device.

RF Micro Devices believes the furnished information is correct and accurate at the time of this printing. However, RF Micro Devices reserves the right to make changes to its products without notice. RF Micro Devices does not assume responsibility for the use of the described product(s).

6

MIXERS

| Parameter  | Specification |      |      | Unit | Condition                            |
|--|---------------|------|------|------|--------------------------------------|
|  | Min.          | Typ. | Max. |      |                                      |
| <b>Upconverter</b>   |               |      |      |      |                                      |
| <b>Both Bands</b>  |               |      |      |      |                                      |
| Unless stated otherwise, all data in this section is for both Cellular and PCS bands.<br>T=25°C, V <sub>CC</sub> =2.75V. |               |      |      |      |                                      |
| IF Frequency Range   | 100           |      | 250  | MHz  |                                      |
| LO Input Level   | -9            | -6   | -2   | dBm  |                                      |
| RF to LO Isolation   | 20            | 30   |      | dBm  |                                      |
| IF to RF Isolation   | 40            |      |      | dBm  |                                      |
| IF to LO Isolation   | 34            |      |      | dBm  |                                      |
| IF Input Impedance Differential  |               | 260  |      | Ω    |                                      |
| IF Input Return Loss Differential  | 10            |      |      | dB   |                                      |
| LO Input Impedance Single-Ended  |               | 50   |      | Ω    |                                      |
| LO Input Return Loss Single-Ended  | 10            |      |      | dB   |                                      |
| RF Output Impedance Single-Ended   |               | 50   |      | Ω    |                                      |
| RF Output Return Loss Single-Ended   | 10            |      |      | dB   |                                      |
| <b>Cellular Band</b>   |               |      |      |      |                                      |
| RF Output Frequency  | 824           |      | 849  | MHz  | RF=835MHz, LO=990MHz @ -3dBm         |
| LO Frequency Range   | 909           |      | 1099 | MHz  |                                      |
| IF-RF Conversion Gain  | -2            | 0    | 2    | dB   |                                      |
| Noise Figure   |               | 12   | 13   | dB   | Room Temp.                           |
|  |               | 13   | 14   |      | Over Temp.                           |
| Output IP3 (Linearity)   | 10.5          | 13.0 |      | dBm  | See Note 1 (end of parameter table). |
| Output P1dB  | -3            | -1   |      | dBm  |                                      |
| LO to RF Output Leakage  |               | -30  |      | dBm  |                                      |
| <b>PCS Band</b>  |               |      |      |      |                                      |
| RF Output Frequency  | 1850          |      | 1910 | MHz  | RF=1880MHz, LO=2030MHz @ -3dBm       |
| LO Frequency Range   | 1950          |      | 2160 | MHz  |                                      |
| IF-RF Conversion Gain  | -2            | 0    | 2    | dB   |                                      |
| Noise Figure   |               | 14.0 | 14.5 | dB   | Room Temp.                           |
|  |               | 15.0 | 16.5 |      | Over Temp.                           |
| Output IP3 (Linearity)   | 8.5           | 12.0 |      | dBm  | See Note 1 (end of parameter table). |
| Output P1dB  | -4            | -2   |      | dBm  |                                      |
| LO to RF Output Leakage  |               | -17  |      | dBm  |                                      |

| Parameter                                  | Specification |          |          | Unit     | Condition  |   |
|--|---------------|----------|----------|----------|--|---|
|  | Min.          | Typ.     | Max.     |          |  |   |
| <b>Amplifiers/Attenuators</b>              |               |          |          |          |  |   |
| <b>Both Bands</b>                          |               |          |          |          |  |   |
| Gain Control Range                         | 17            | 20       |          | dB       | Unless stated otherwise, all data in this section is for both Cellular and PCS bands.<br>T=25°C, V <sub>CC</sub> =2.75V. |   |
| Gain Control Voltage                       | 0.8           |          | 1.9      | V        |  |   |
| Gain Control Slope                         |               | 15       | 35       | dB/V     |  |   |
| Input Impedance<br>Single-Ended            |               | 50       |          | Ω        |  |   |
| Input Return Loss<br>Single-Ended          | 10            |          |          | dB       |  |   |
| Output Impedance<br>Single-Ended           |               | 50       |          | Ω        |  |   |
| Output Return Loss<br>Single-Ended         | 10            |          |          | dB       |  |   |
| RF Output Collector Current<br>Consumption |               | 10       |          | mA       |  |   |
| Upconverter Output to<br>Amplifier Input   | 35            | 40       |          | dB       |  | Any load.   |
| <b>Cellular Band</b>                       |               |          |          |          |  |   |
| RF Frequency Range                         | 824           |          | 849      | MHz      | Amplifier + Attenuator<br>Amplifier + Attenuator   |   |
| Maximum Gain                               | 5             | 7        | 9        | dB       |  |   |
| Noise Figure at Maximum Gain               |               |          | 2.5      | dB       |  |   |
| Noise Figure Increase with<br>Attenuation  |               |          | 0.75     | dB/dB    |  |   |
| Input IP3 (Linearity)                      | -1            | 1        |          | dBm      |  | @ all gain levels<br>See Note 1 (end of parameter table). |
| <b>PCS Band</b>                            |               |          |          |          |  |   |
| RF Frequency Range                         | 1850          |          | 1910     | MHz      | Amplifier + Attenuator<br>Amplifier + Attenuator   |   |
| Maximum Gain                               | 4             | 6        | 8        | dB       |  |   |
| Noise Figure at Maximum Gain               |               |          | 3.5      | dB       |  |   |
| Noise Figure Increase with<br>Attenuation  |               |          | 0.75     | dB/dB    |  |   |
| Input IP3 (Linearity)                      | -1            | 0        |          | dBm      |  | See Cellular Band Input IP3 Conditions.                   |
| <b>Control and Power</b>                   |               |          |          |          |  |   |
| <b>Consumption</b>                         |               |          |          |          |  |   |
| Operating Voltage                          | 2.7           |          | 3.0      | V        | HIGH (Device ON)<br>LOW (Device OFF)   |   |
| Power Down Control                         | 2.1           |          | 0.5      | V        |  |   |
| Power Down Pin Impedance                   | 20            |          |          | kΩ       | PCS (HIGH)<br>Cellular (LOW)   |   |
| Band-Select Control (BS)                   | 2.1           |          | 0.5      | V        |  |   |
| Band Select Pin Impedance                  | 20            |          |          | kΩ       | PD=LOW<br>Cellular, BS=LOW<br>PCS, BS=HIGH   |   |
| Device OFF Current                         |               |          | 10       | uA       |  |   |
| Total Current (PD=HIGH)                    |               | 30<br>33 | 37<br>42 | mA<br>mA |  |   |

NOTE 1: OIP3 was measured using a two-tone test. Each injected tone had an input power (at the RF output of the upconverter) of -18dBm with a frequency spacing of 100kHz.

| Pin | Function    | Description  | Interface Schematic |
|-----|-------------|--|---------------------|
| 1   | PD          | Power Down Control. When Logic "high" (greater than 2.1 V) the device is active and all circuits are operating. When logic "low" (less than 0.5V) the device is inactive and all circuits are turned off.  |                     |
| 2   | LO          | Single-ended LO input pin. This pin is internally DC biased and should be DC blocked if it is connected to a device with a DC level present. The single-ended input impedance is 50Ω.  |                     |
| 3   | BYPASS      | Bypass pin for internal bias circuitry. Bypass with 10nF capacitor.  |                     |
| 4   | IF+         | Balanced IF input pin. This pin is internally DC biased and should be DC blocked if connected to a device with a DC level present. The differential input impedance is 260Ω. For single ended input operation, one pin is used as an input and the other IF input is AC coupled to ground. |                     |
| 5   | IF-         | Same as pin 4, except complementary input.   |                     |
| 6   | PCS MIXOUT  | RF mixer output pin for the PCS system. PCS Mixout output impedance depends on the LC match and it is influenced by the bypass capacitor at VCC2.  |                     |
| 7   | VCC MIX     | Supply voltage pin for the mixer. External bypassing is required. The trace length between the pin and the bypass capacitors should be minimized. The ground side of the bypass capacitors should connect immediately to ground plane.   |                     |
| 8   | VCC         | Supply voltage pin for all the control and bias circuitry. A bias choke inductor and RF bypass capacitor is required.  |                     |
| 9   | PCS VCC     | Supply voltage pin for the PCS driver. This pin is an open collector and it will need a bias choke inductor and RF bypass. A parallel resistor to the inductor improves stability of the driver amplifier.   |                     |
| 10  | PCS IN      | Single-ended input for the PCS driver and attenuator. External matching is required. This pin is internally DC biased and should be DC blocked if it is connected to a device with a DC level present.   |                     |
| 11  | PCS ATT GND | PCS attenuator ground pin. This pin should be AC ground. The trace length between the pin and the bypass capacitors should be minimized. The value of the capacitor is chosen to resonate in the PCS band.   |                     |
| 12  | PCS OUT     | PCS RF output pin. External matching is required. This pin is internally DC biased and should be DC blocked if it is connected to a device with a DC level present.  |                     |

| Pin      | Function     | Description   | Interface Schematic |
|----------|--------------|---|---------------------|
| 13       | VGC          | Analog gain control for the driver amplifier. Valid control voltage ranges from $0.8V_{DC}$ to $1.9V_{DC}$ .  |                     |
| 14       | CELL OUT     | Cellular RF output pin. External matching is required. External matching is required. This pin is internally DC biased and should be DC blocked if it is connected to a device with a DC level present.                                       |                     |
| 15       | CELL ATT GND | Cell attenuator ground pin. This pin should be AC ground. The trace length between the pin and the bypass capacitors should be minimized. The value of the capacitor is chosen to resonate in the PCS band.                                   |                     |
| 16       | CELL IN      | Singled end input for the cellular driver and attenuator. External matching is required. This pin is internally DC biased and should be DC blocked if it is connected to a device with a DC level present.                                    |                     |
| 17       | CELL GND     | This pin should be choke to ground. The inductor is used to adjust the linearity of the cellular driver.  |                     |
| 18       | CELL VCC     | Supply voltage pin for the cell driver. This pin is an open collector and it will need a bias choke inductor and RF bypass. A parallel resistor to the inductor improves stability of the driver amplifier.                                   |                     |
| 19       | SEL          | Band select control pin for the drivers. When Logic "high" (greater than 2.1 V) the PCS band is active. When logic "low" (less than 0.5V) the Cellular Band is active.  |                     |
| 20       | CELL MIXOUT  | RF mixer output pin for the PCS system. PCS Mixout output impedance depends on the LC match and it is influenced by the bypass capacitor at VCC2.   |                     |
| Pkg Base | GND          | Ground connection. The backside of the package should be soldered to a top side ground pad, which is connected to the ground plane. Additional ground connections are offered at each corner of the package for flexibility in layout design. |                     |

**Application Schematic**

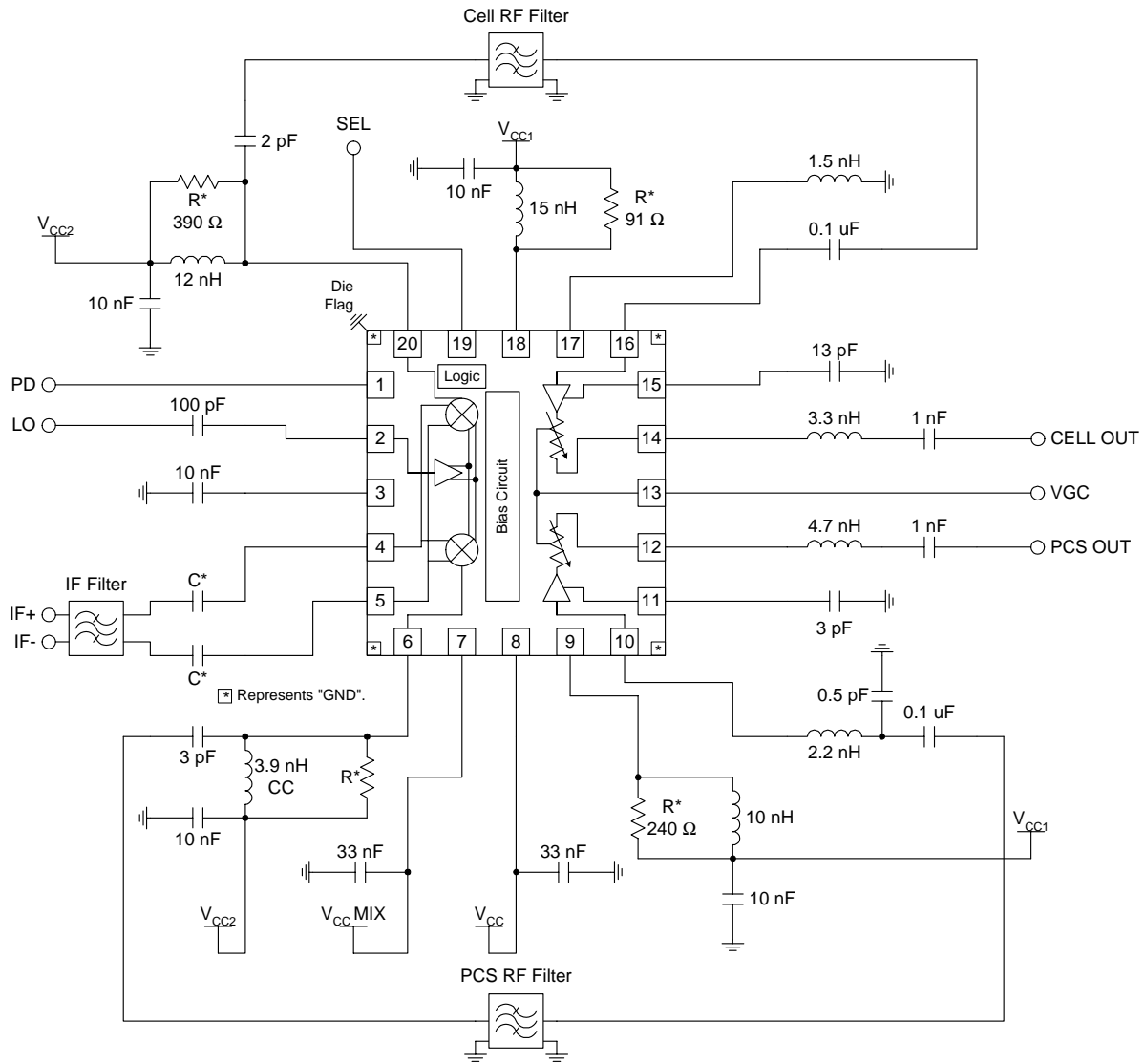

**NOTES:**

1. All components marked with "R\*" are De-Q resistors.
2. All components marked with "C\*" should be present, if IF SAW filter has a direct path to ground.

**6**  
**MIXERS**

Evaluation Board Schematic  
 IF = 155 MHz  
 (Download [Bill of Materials](http://www.rfmd.com) from www.rfmd.com.)

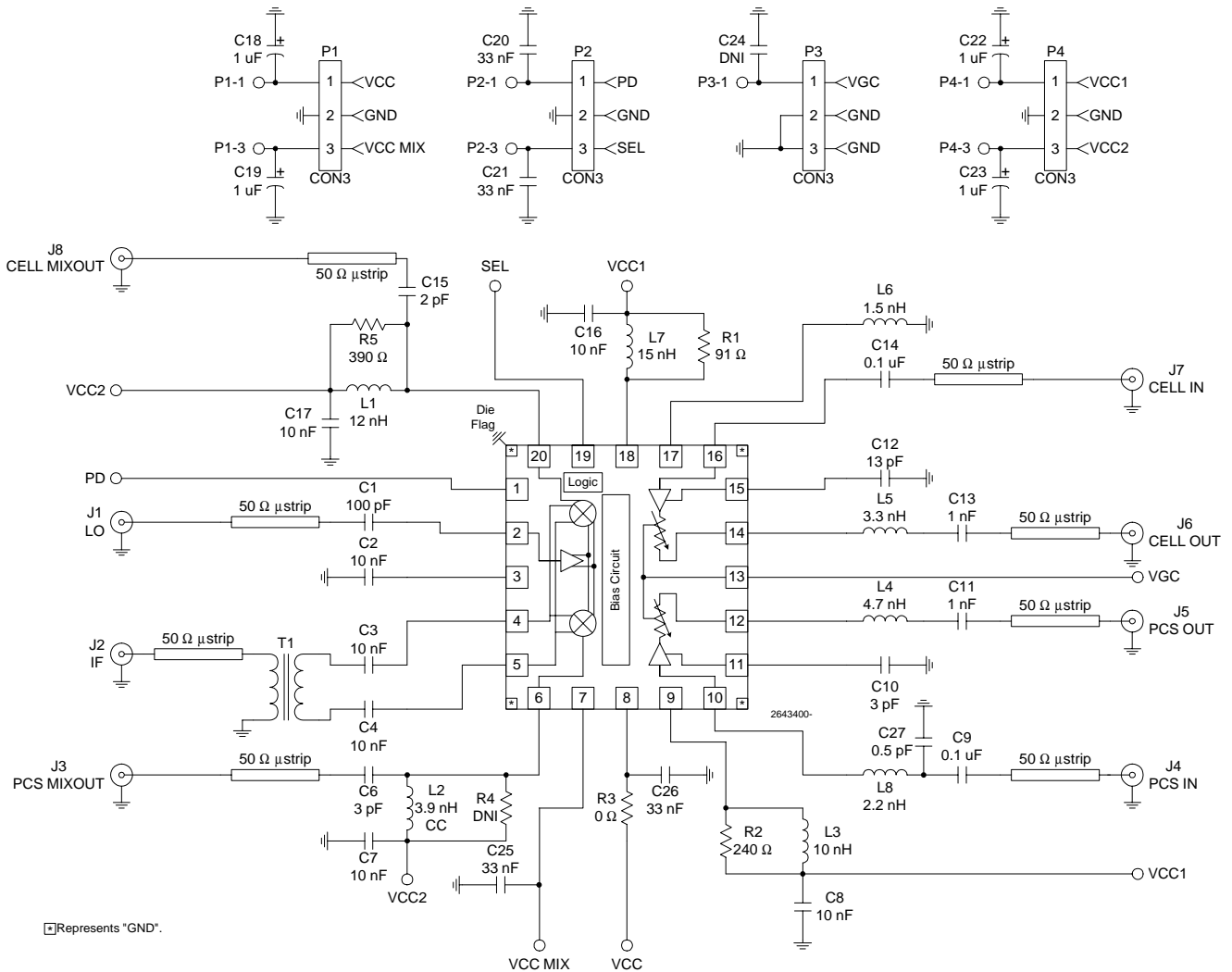

## Evaluation Board Layout Board Size 2.0" x 2.0"

Board Thickness 0.064", Board Material FR-4, Multi-Layer

Assembly

Top

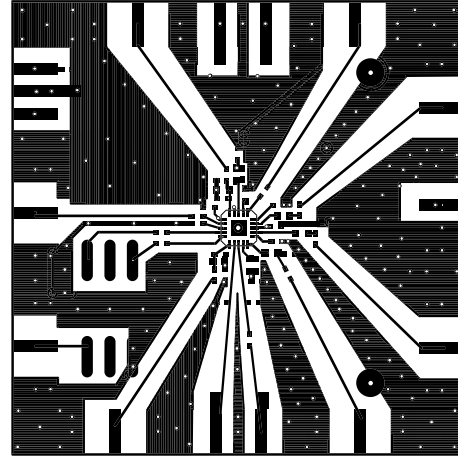
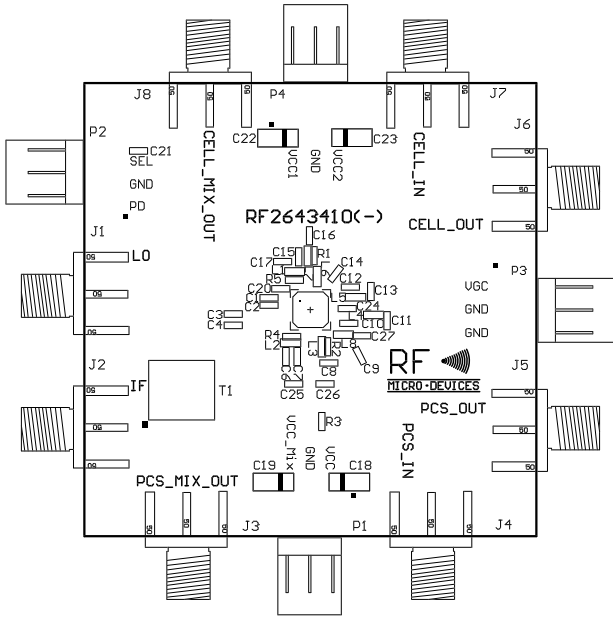

Inner 1 - Ground Plane 1

Inner 2 - Power Plane 1

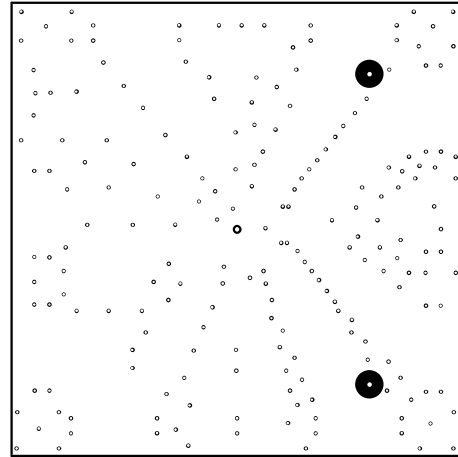
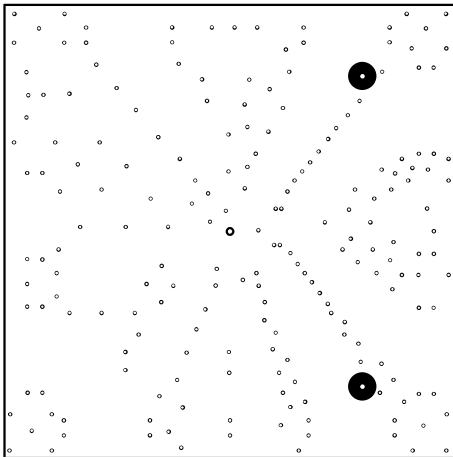

**6**  
MIXERS



Inner 3 - Ground Plane 2

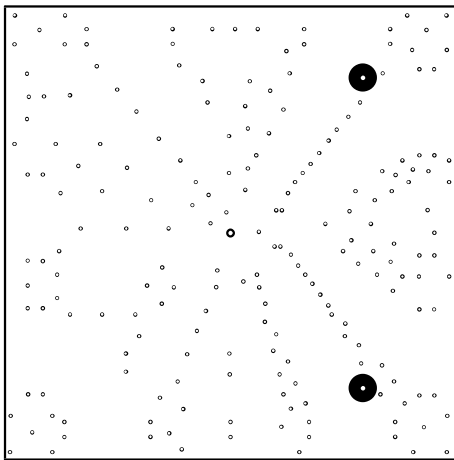

Inner 4 - Power Plane 2

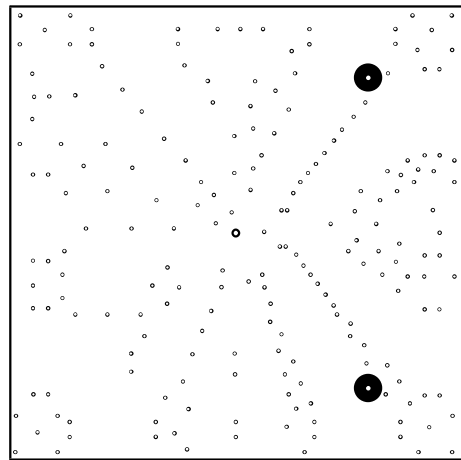

Back

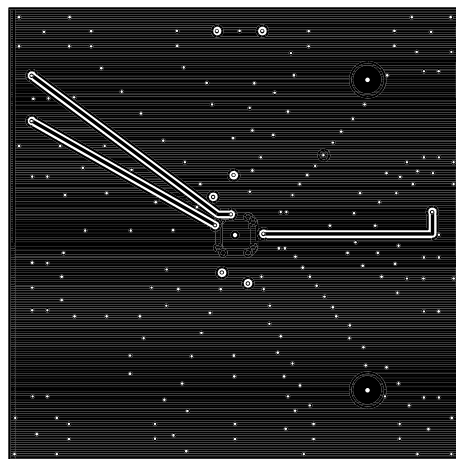

**Power Down Current**

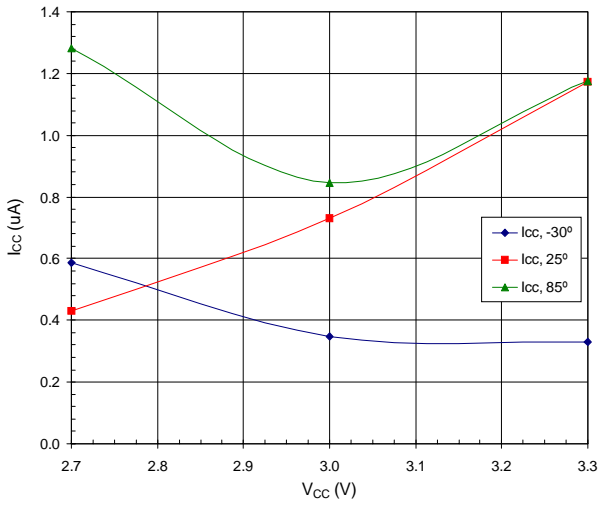

**Cellular Current**

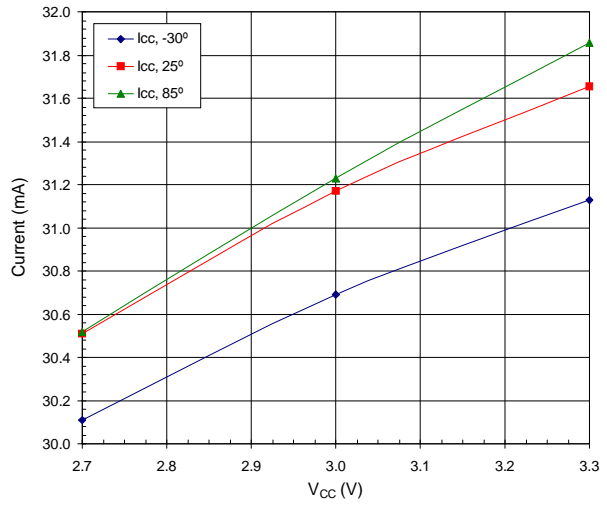

**Cellular Mixer Conversion Gain @ LO = -10 dBm**

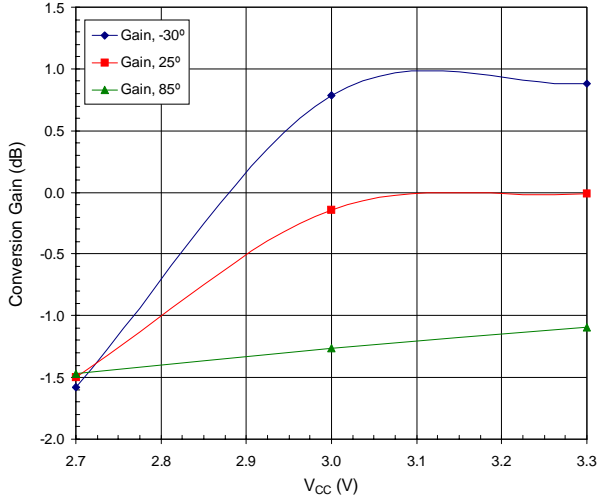

**Cellular Mixer Conversion Gain @ LO = -3 dBm**

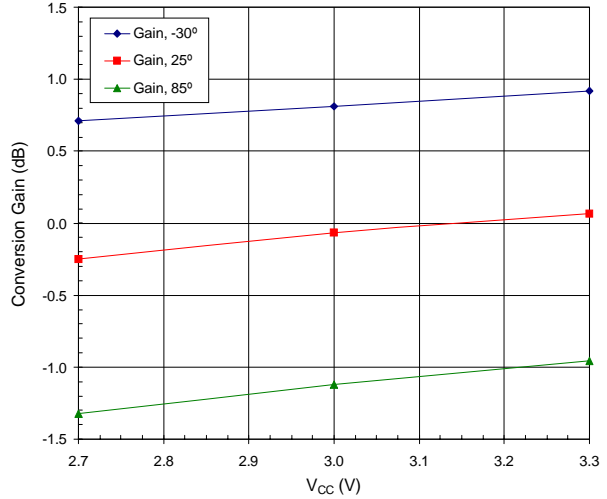

**Cellular LO to RF Leakage @ LO = -10 dBm**

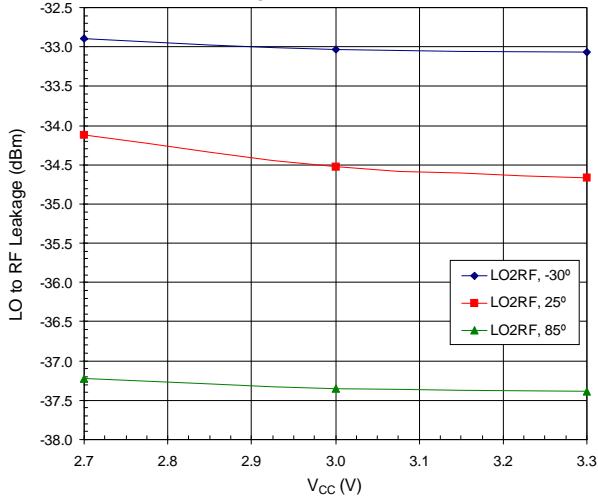

**Cellular LO to RF Leakage @ LO = -3 dBm**

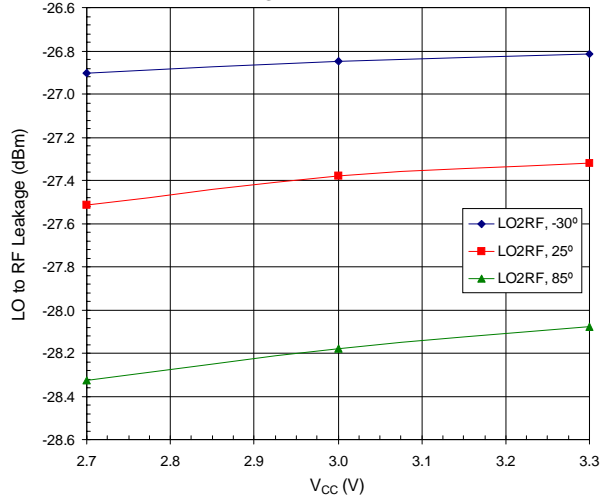

Cellular Mixer OIP3  
@ LO = -10 dBm

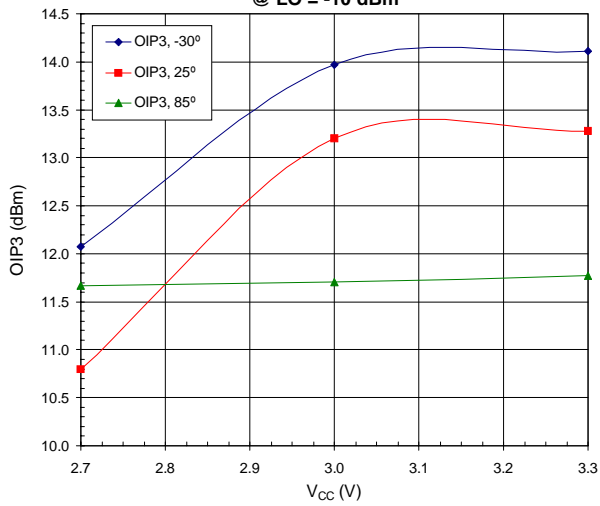

Cellular Mixer OIP3  
@ LO = -3 dBm

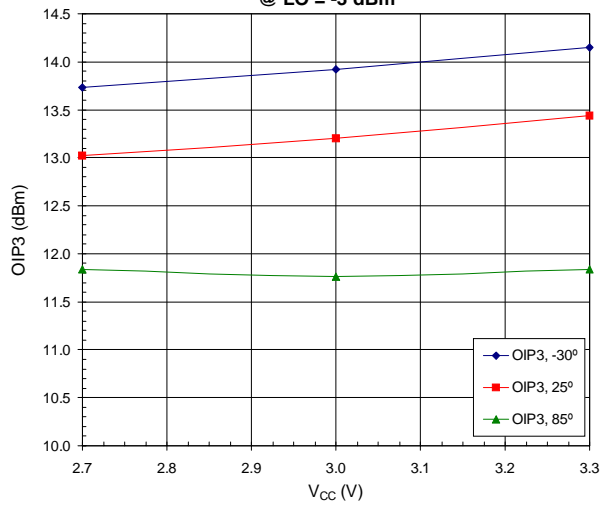

Cellular Mixer Noise Figure  
@ LO = -10 dBm

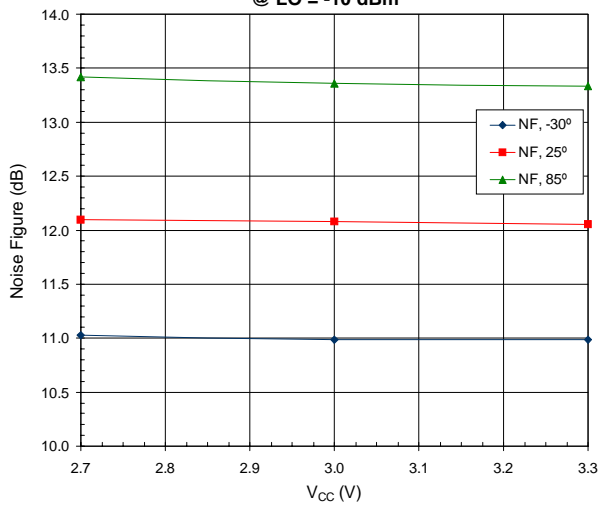

Cellular Mixer Noise Figure  
@ LO = -3 dBm

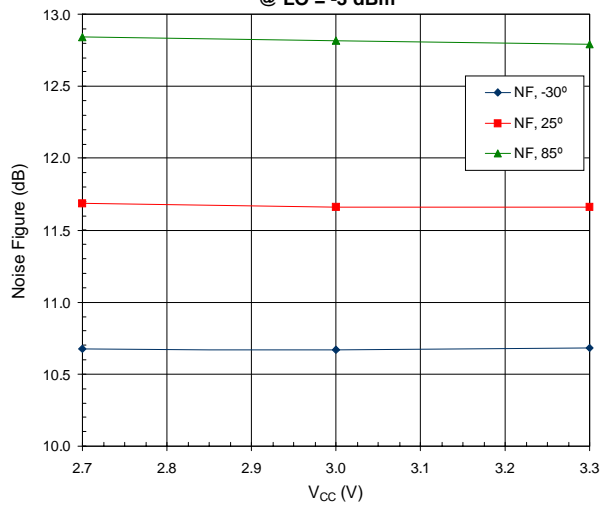

Cellular Mixer Gain  
@ 25°C

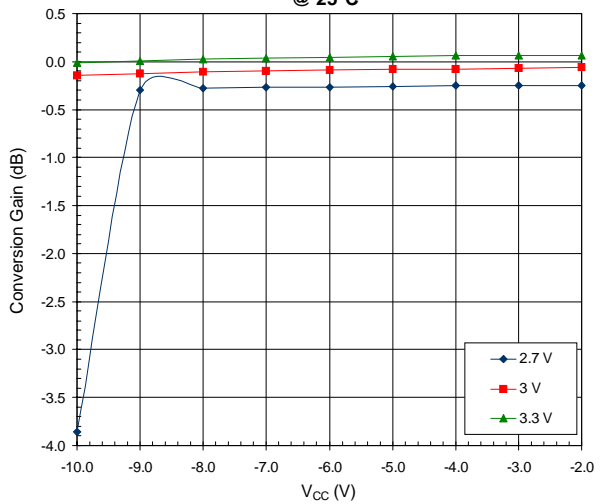

Cellular Mixer OIP3  
@ 25°C

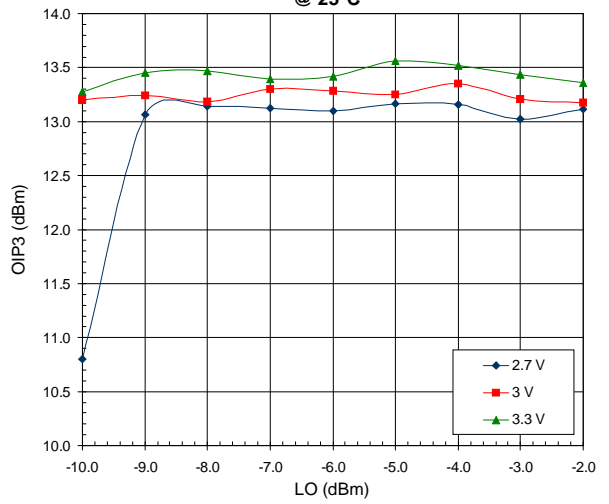

Cellular Mixer Noise Figure @ 25°C

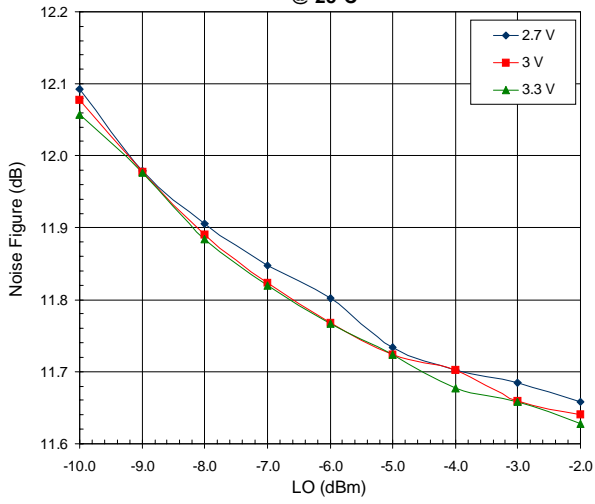

Cellular Gain Driver @ 25°C

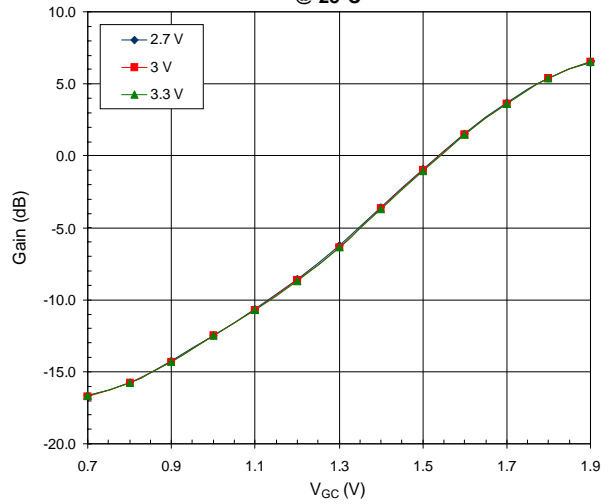

Cellular Driver IIP3 @ 25°C

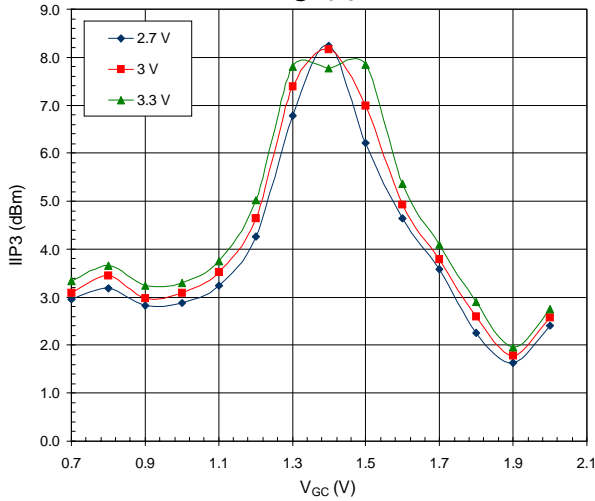

Cellular Noise Figure Driver @ 25°C

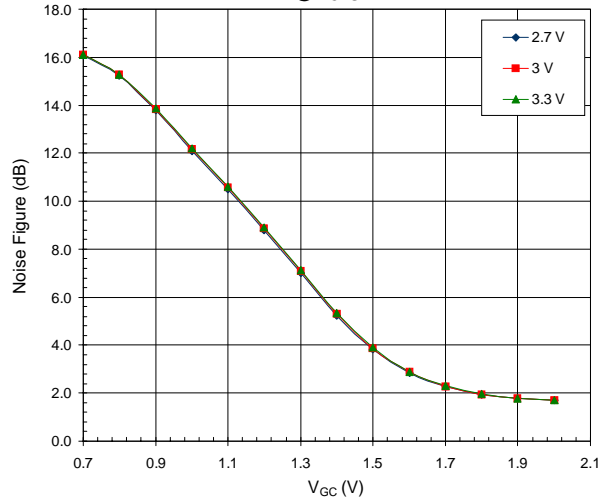

Cellular Gain Driver @ 2.7 V

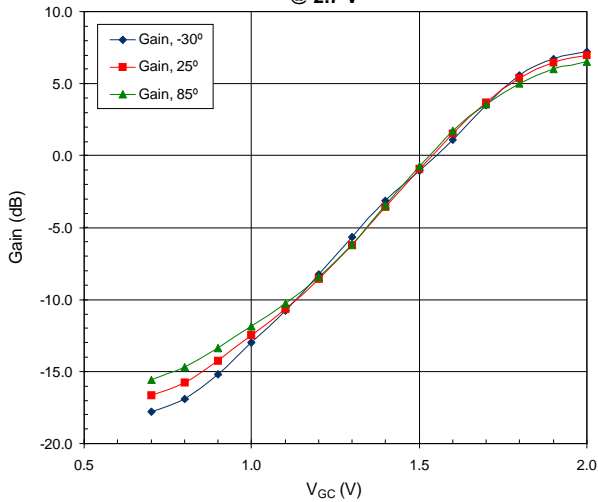

Cellular Driver IIP3 @ 2.7 V

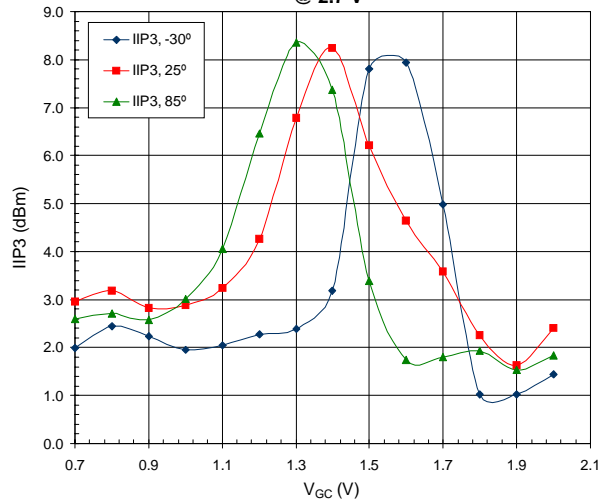

Cellular Driver Noise Figure  
@ 2.7 V

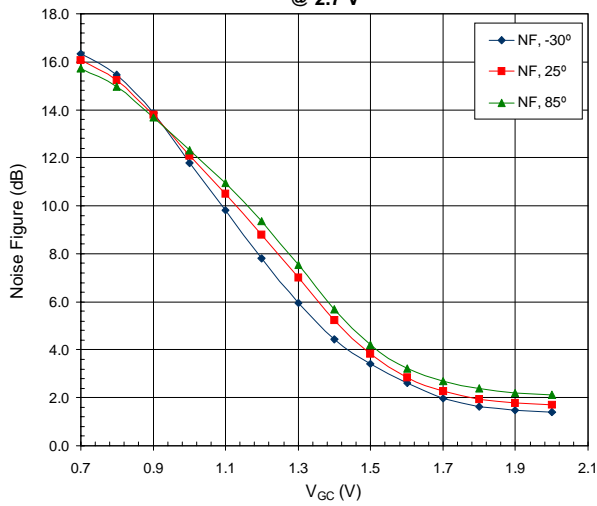

PCS Current

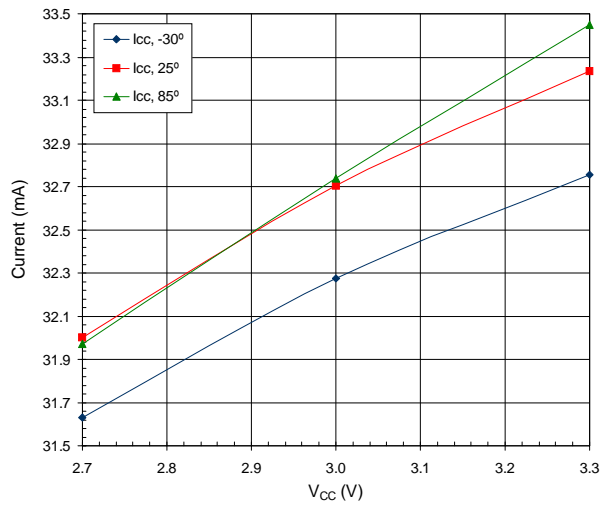

PCS Mixer Conversion Gain  
@ LO = -10 dBm

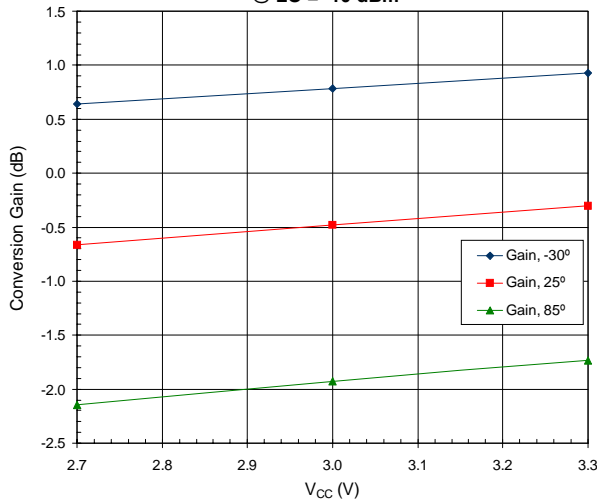

PCS Mixer Conversion  
@ LO = -3 dBm

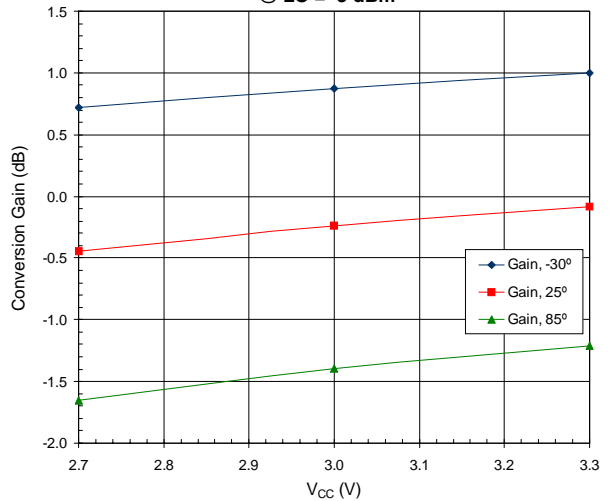

PCS LO to RF Leakage  
@ LO = -10 dBm

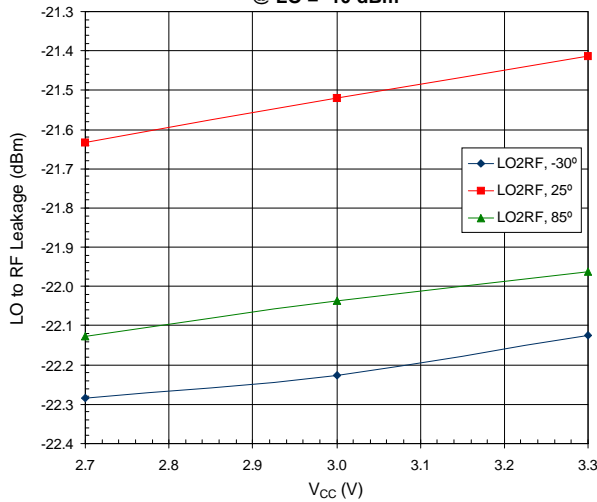

PCS LO to RF Leakage  
@ LO = -3 dBm

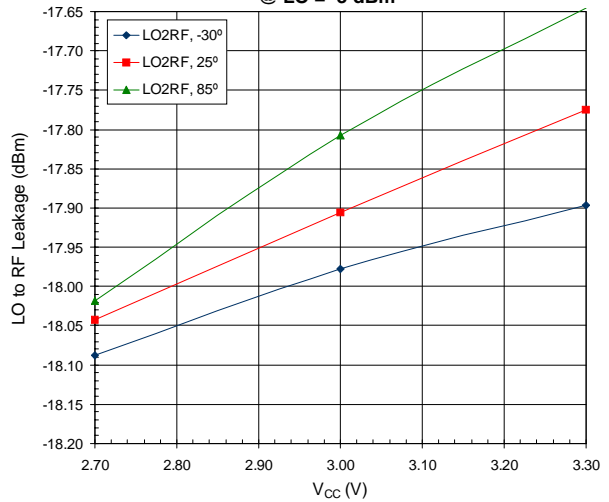

**PCS Mixer OIP3**  
@ LO = -10 dBm

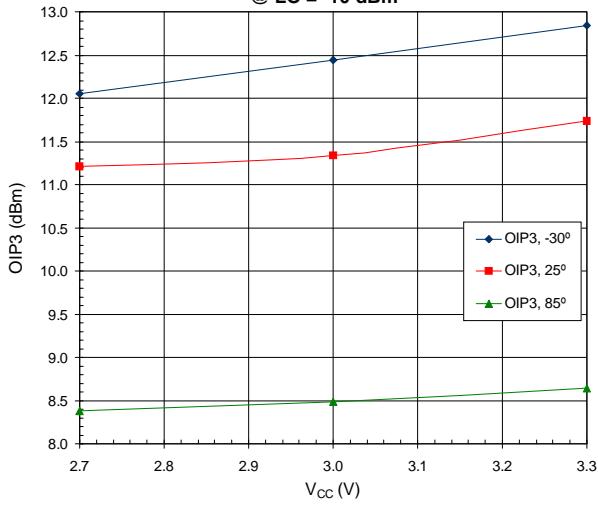

**PCS Mixer OIP3**  
@ LO = -3 dBm

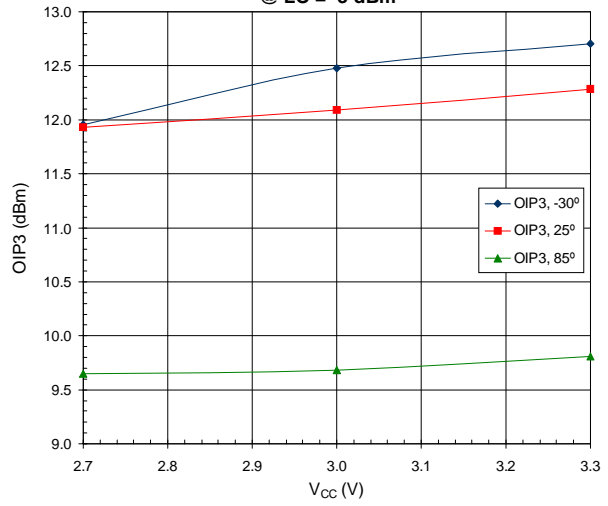

**PCS Mixer Noise Figure**  
@ LO = -10 dBm

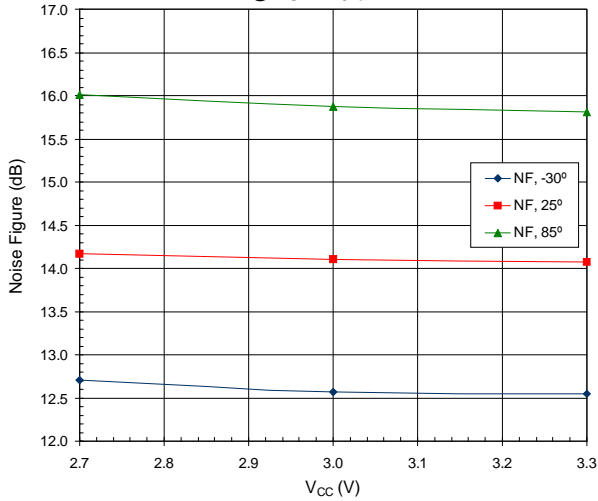

**PCS Mixer Noise Figure**  
@ LO = -3 dBm

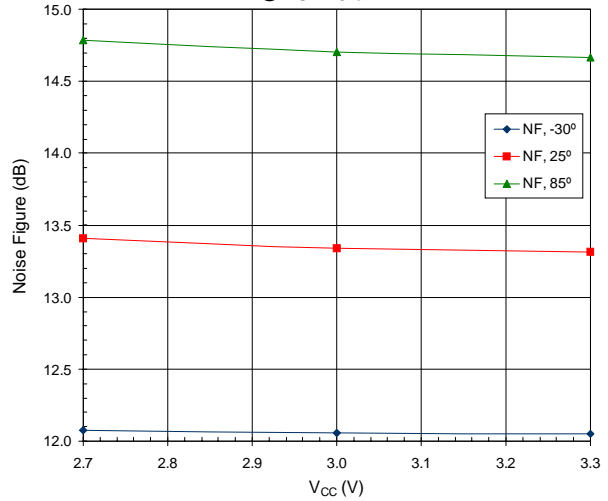

**PCS Mixer Conversion Gain**  
@ 25°C

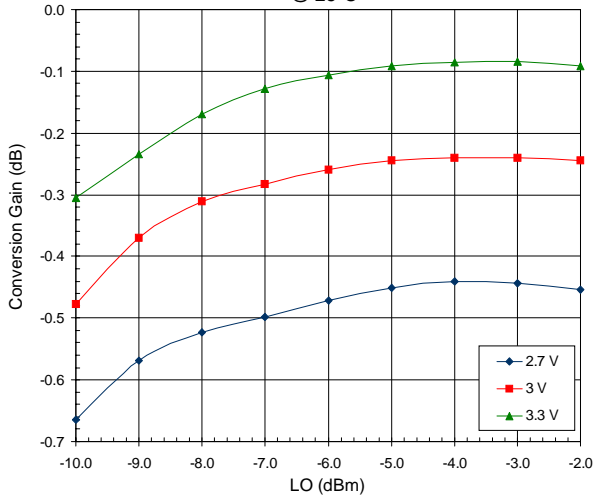

**PCS Mixer OIP3**  
@ 25°C

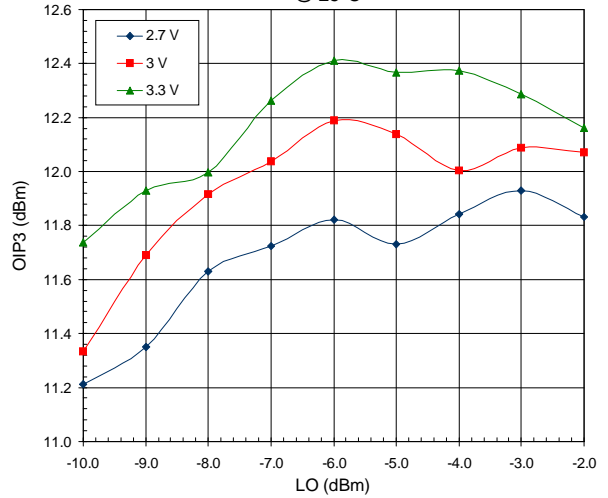

PCS Mixer Noise Figure @ 25°C

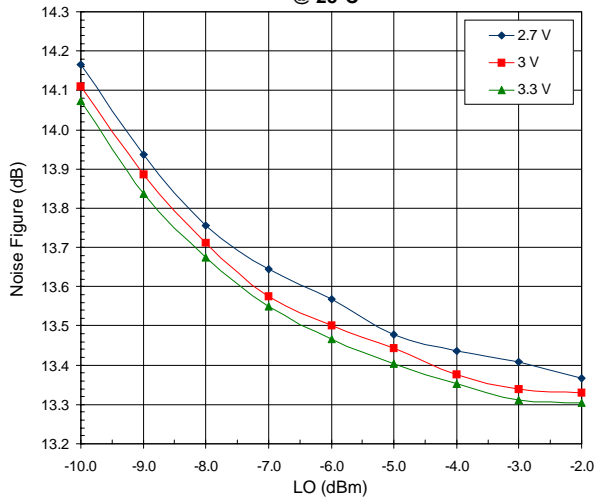

PCS Gain Driver @ 25°C

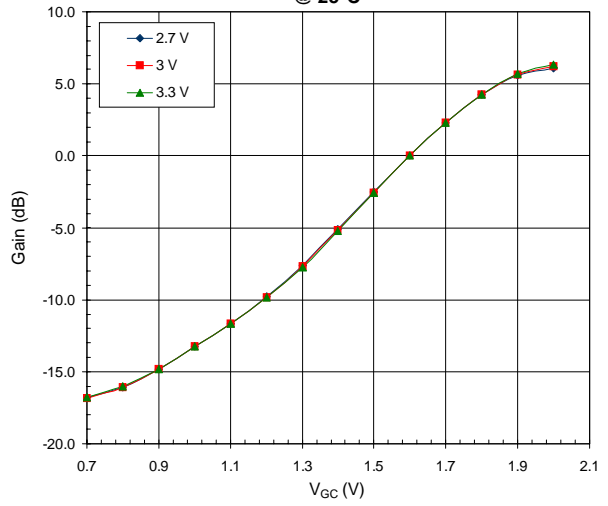

PCS IIP3 Driver @ 25°C

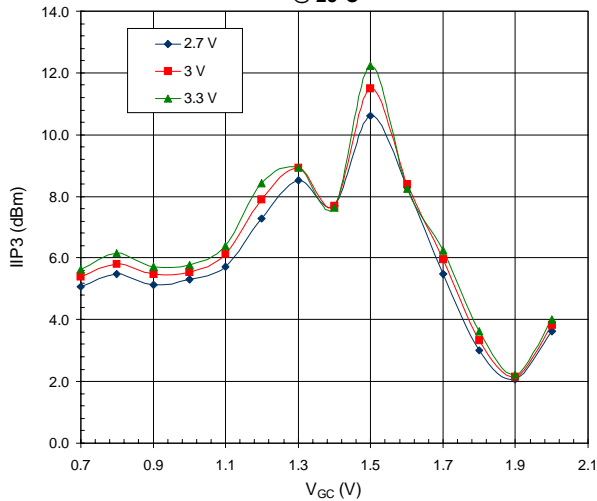

PCS Noise Figure Driver @ 25°C

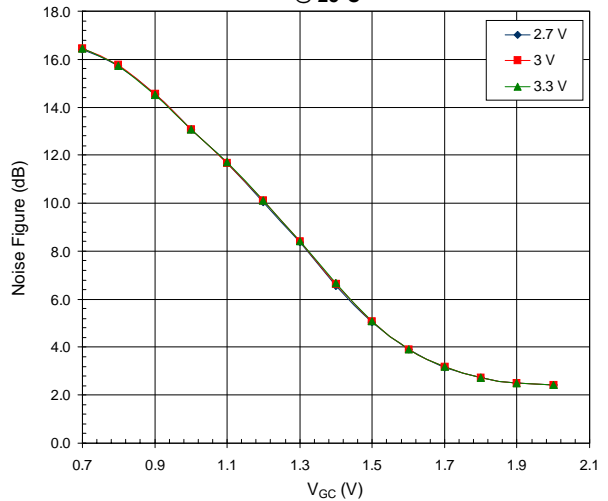

PCS Gain Driver @ 2.7 V

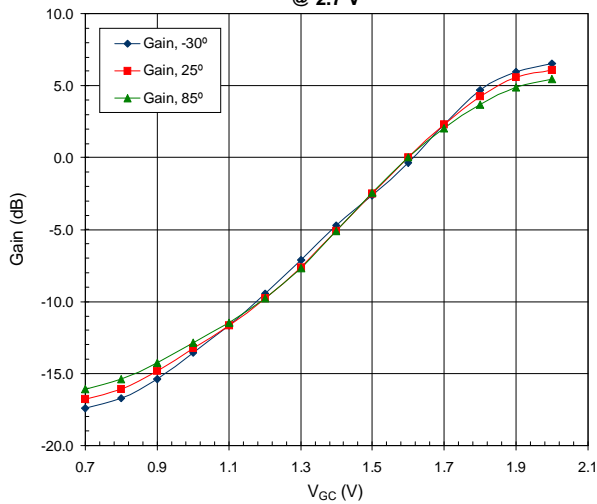

PCS IIP3 Driver @ 2.7 V

