

## ■ Features

- (1) For equipment designed to conform EMI regulations such as VCCI, CISPR, FCC, VDE, etc.
- (2) Attenuates conductive emission from power supply
- (3) Leakage current: 1mA max. (250V, 60Hz)
- (4) Compact and light weight

## ■ Safety standard

UL1283, CSA Std. C22. 2 No. 8

VDE0565 Teil. 3

(VDE0565 will transfer to EN133200 on and after July 23, 2003.)

## ■ Specifications

Item	Model	PBW-1201-33	PBW-1202-33	PBW-1203-33	PBW-1206-33
1	Rated voltage (AC, DC)	250V			
2	Rated current (AC, DC) (Note)	1A	2A	3A	6A
3	Test voltage (terminal to case, AC 1 minute)	1500V			
4	Isolation resistance (terminal to case, 500VDC)	100MΩ min.			
5	Leakage current	125V, 60Hz			
		250V, 60Hz			
6	DC resistance	1.2Ω max.	0.4Ω max.	0.25Ω max.	0.12Ω max.
7	Temperature rise	30°C max.			
8	Operating temperature range	-25 ~ +85°C			
9	Weight (typ)	60g	60g	60g	60g

(Note) : Value at Ta ≤ 55°C. Refer to the derating curve shown below at Ta > 55°C.

## ■ Circuit

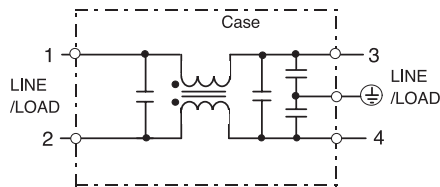

## ■ Derating

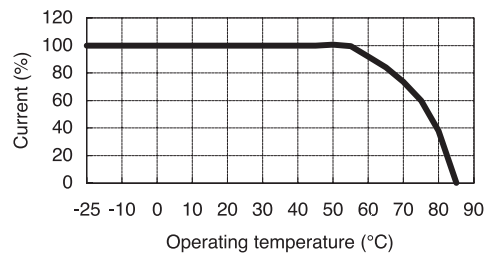

## ■ Outline drawings

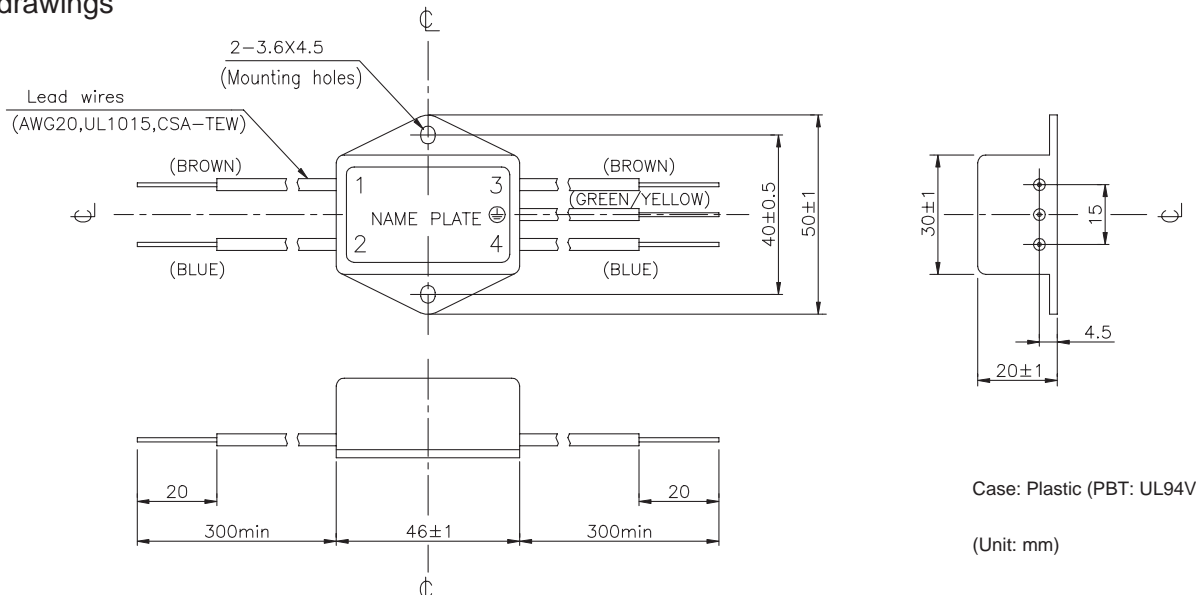

- Request customer specification for further details of specifications, outline, characteristics, etc. Read the instruction manual before usage.
- Contact us about delivery before ordering.

## CHARACTERISTICS

■ Typical Insertion Loss     ..... Symmetrical  
 ——— Asymmetrical

**PBW-1201-33**

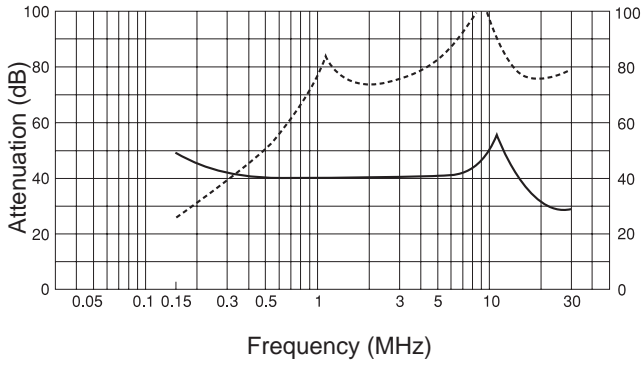

**PBW-1202-33**

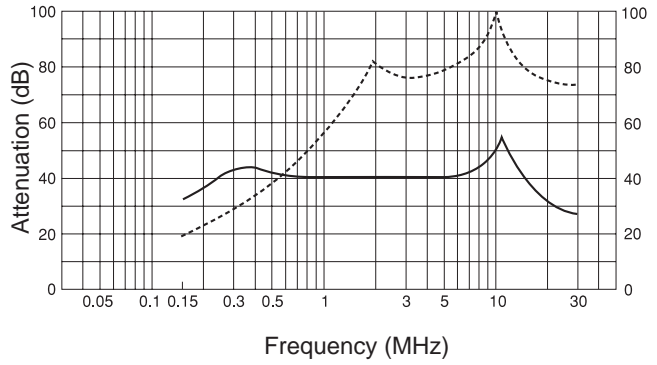

**PBW-1203-33**

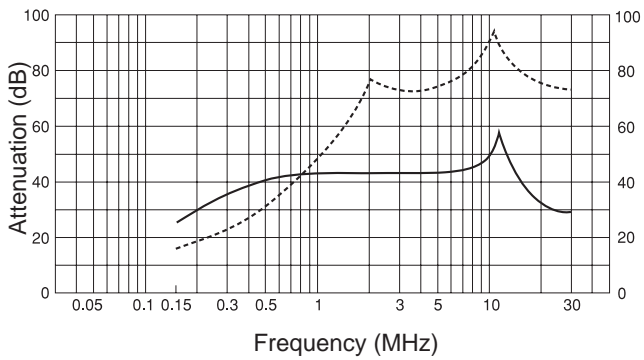

**PBW-1206-33**

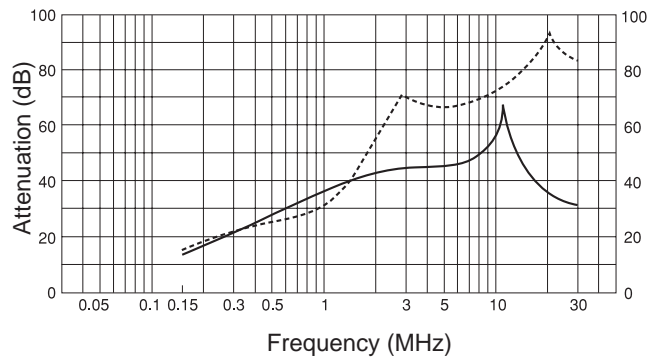

**Noise Filter**