

Silicon Hot-Carrier Diodes

Schottky Barrier Diodes

LMBD301LT1

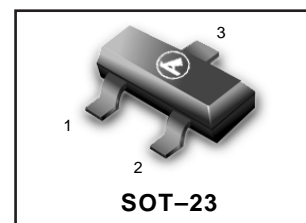

These devices are designed primarily for high-efficiency UHF and VHF detector applications. They are readily adaptable to many other fast switching RF and digital applications. They are supplied in an inexpensive plastic package for low-cost, high-volume consumer and industrial/commercial requirements. They are also available in a Surface Mount package.

- Extremely Low Minority Carrier Lifetime –15ps(Typ)
- Very Low Capacitance –1.5pF(Max)@V_R=15V
- Low Reverse Leakage –I_R=13 nAdc(Typ) LMBD301

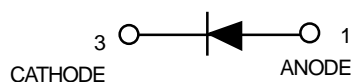

MAXIMUM RATINGS(T_J=125°C unless otherwise noted)

Rating	symbol	LBD301		LMBD301LT1	
		value	unit	value	unit
Reverse Voltage	V _R	30	Volts		
Forward Power Dissipation @TA=25 °C	P _F	280	mW	200	mW
		Derate above 25 °C	2.8	mW/°C	2.0
Operating Junction Temperature Range	T _J	-55 to +125		°C	
Storage Temperature Range	T _{stg}	-55 to +150		°C	

DEVICE MARKING

LMBD301LT1=4T

ELECTRICAL CHARACTERISTICS(T_A=25 °C unless otherwise noted)

Characteristic	Symbol	Min	Typ	Max	Unit
Reverse Breakdown Voltage(I _R =10μA)	V _{(BR)R}	30	—	—	Volts
Total Capacitance(V _R =15V,f=1.0MHz,)Figure1	C _T	—	0.9	1.5	pF
Reverse Leakage(V _R =25V)Figure3	I _R	—	13	200	nAdc
Forward Voltage(IF=1.0mAdc)Figure4	V _F	—	0.38	0.45	Vdc
Forward Voltage(IF=10mAdc)Figure4	V _F	—	0.52	0.6	Vdc

NOTE:LMBD301LT1 is also available in bulk packaging.Use LMBD301L as the device title to order this device in bulk.

LMBD301LT1

TYPICAL ELECTRICAL CHARACTERISTICS

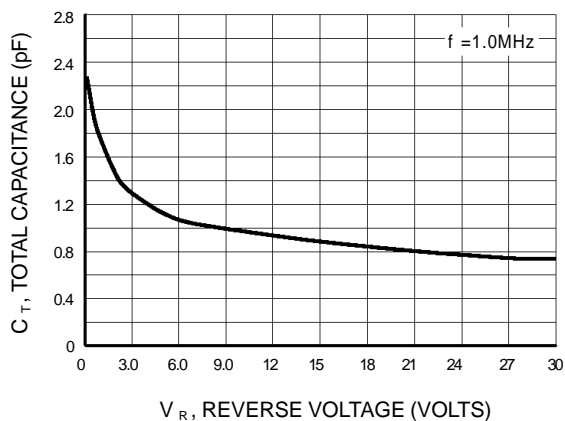

Figure 1. Total Capacitance

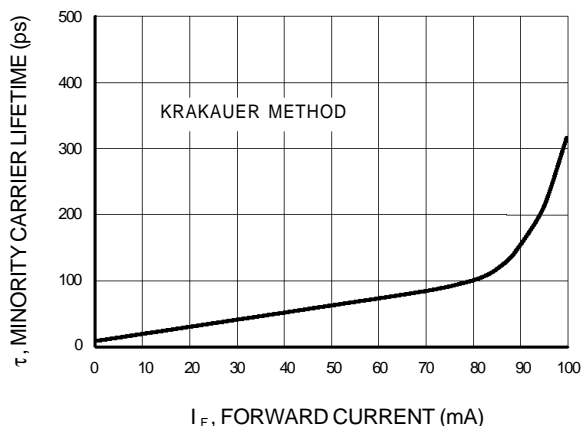

Figure 2. Minority Carrier Lifetime

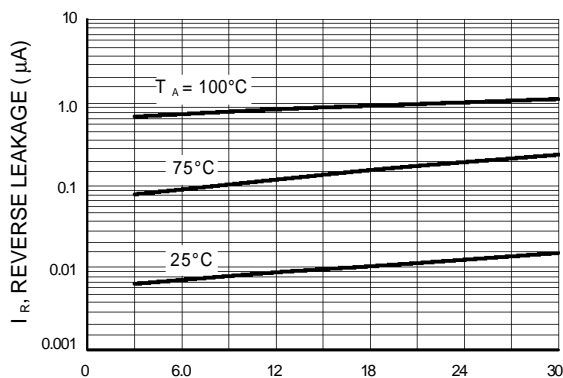

Figure 3. Reverse Leakage

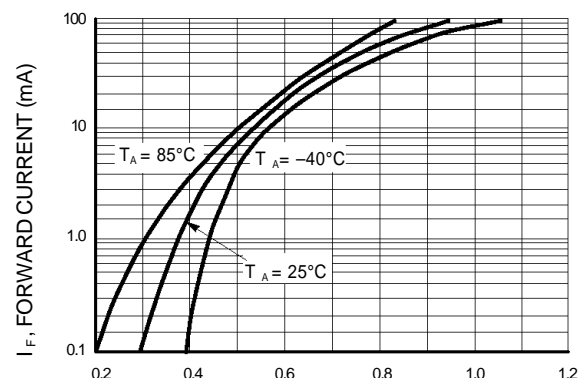

Figure 4. Forward Voltage

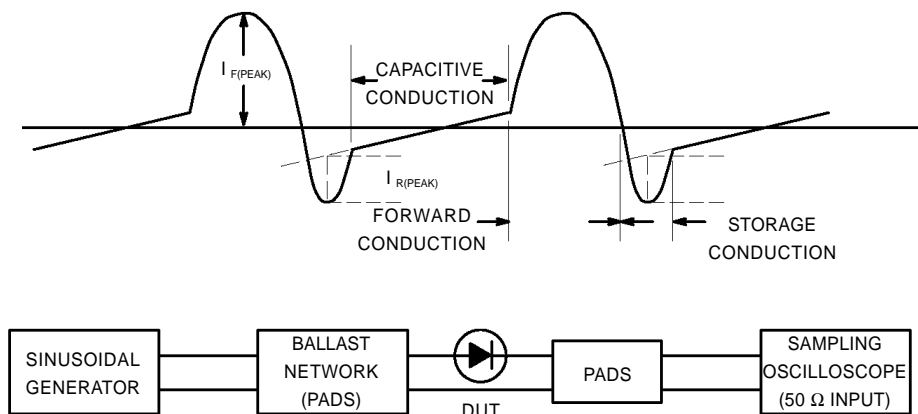
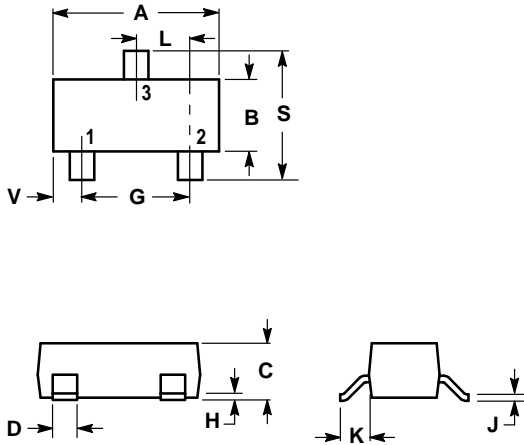

Figure 5. Krakauer Method of Measuring Lifetime

LMBD301LT1

SOT-23



NOTES:

1. DIMENSIONING AND TOLERANCING PER ANSI Y14.5M, 1982.
2. CONTROLLING DIMENSION: INCH.

DIM	INCHES		MILLIMETERS	
	MIN	MAX	MIN	MAX
A	0.1102	0.1197	2.80	3.04
B	0.0472	0.0551	1.20	1.40
C	0.0350	0.0440	0.89	1.11
D	0.0150	0.0200	0.37	0.50
G	0.0701	0.0807	1.78	2.04
H	0.0005	0.0040	0.013	0.100
J	0.0034	0.0070	0.085	0.177
K	0.0140	0.0285	0.35	0.69
L	0.0350	0.0401	0.89	1.02
S	0.0830	0.1039	2.10	2.64
V	0.0177	0.0236	0.45	0.60

- PIN 1. ANODE
 2. NO CONNECTION
 3. CATHODE

