

# PRODUCT SPECIFICATION

<b>COSMO</b> ELECTRONICS CORPORATION	<b>SOLID STATE RELAY:</b> <b>KSD215AC3</b>	<b>SHEET 1 OF 2</b>
---	---	---------------------

## 1. OUTSIDE DIMENSION : UNIT ( mm )

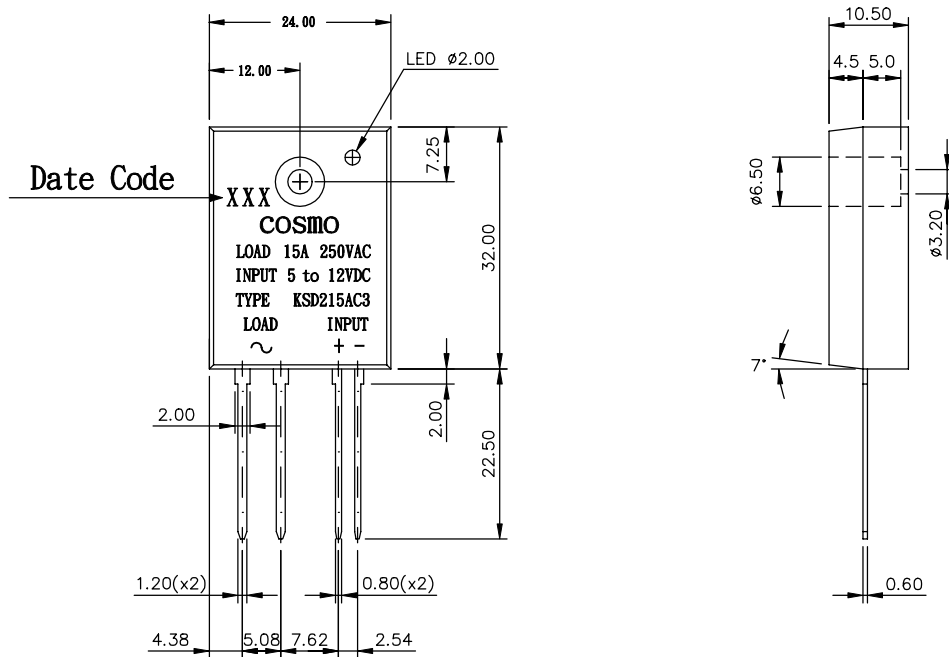

## 2. SCHEMATIC : TOP VIEW

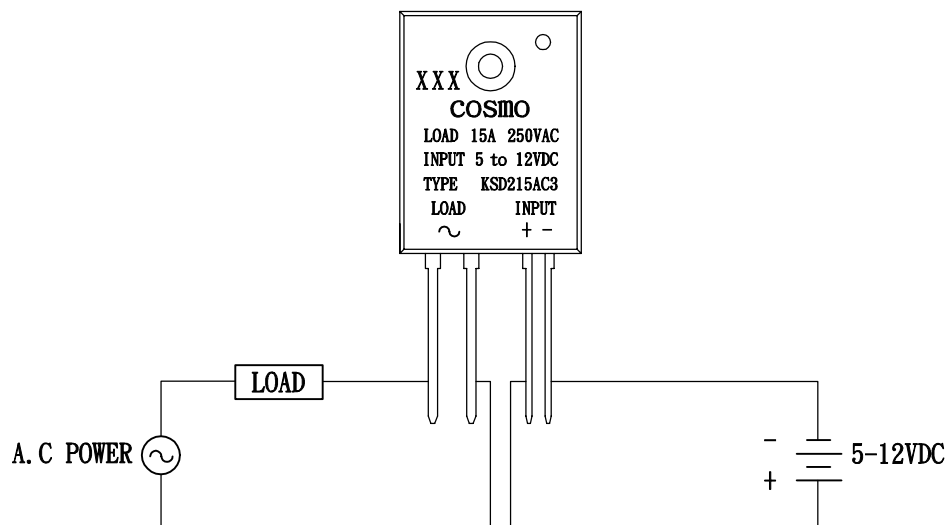

# PRODUCT SPECIFICATION

<b>COSMO</b> ELECTRONICS CORPORATION	SOLID STATE RELAY: <b>KSD215AC3</b>	SHEET 2 OF 2
---	--	--------------

## 3. Absolute Maximum Ratings

(Ta=25°C)

Parameter		Symbol	Rating	Unit
Input	Input signal voltage	V <sub>IN</sub>	5~12	VDC
	Drop-out voltage	V <sub>do</sub>	1	VDC
Output	RMS on-state current	I <sub>T</sub>	15	Arms
	Peak one cycle surge current	I <sub>surge</sub>	150	A
	Repetitive peak-off state voltage	V <sub>DRM</sub>	600	V
	Operating frequency	f	47~70	Hz
	Critical rate of rise of on-state current	di/dt	50	A/us
	Load supply voltage	V <sub>out</sub>	250	V <sub>rms</sub> AC
Isolation voltage input to output		V <sub>iso</sub>	4000	V <sub>rms</sub>
Operating temperature		T <sub>opr</sub>	-30~100	°C
Storage temperature		T <sub>stg</sub>	-30~125	°C
Soldering temperature 10sec		T <sub>sol</sub>	260	°C

## 4. Electrical Characteristics

(Ta=25°C)

Parameter		Symbol	Conditions	MIN	TYP	MAX	Unit
Input	Pick-up voltage	V <sub>pu</sub>	I <sub>t</sub> =1Arms			4	VDC
	Input current	I <sub>in</sub>	V <sub>in</sub> =5~12V	5		25	mA
Output	On-state voltage	V <sub>T</sub>	I <sub>T</sub> =1Arms			1.5	V <sub>rms</sub>
	Operating current	I <sub>op</sub>	V <sub>out</sub> =240v <sub>rms</sub>	50			mArms
	Leakage current	I <sub>leak</sub>	V <sub>out</sub> =240v <sub>rms</sub>			8	mArms
	Critical rate of rise of off-state voltage	dv/dt	See Note 1	50	200		V/us
	Zero-cross voltage	V <sub>ox</sub>	I <sub>in</sub> =7mA	50		35	VAC
	Load Voltage Rating	V <sub>out</sub>	I <sub>T</sub> =50mArms MIN			280	VAC
Minimum trigger current		I <sub>FT</sub>	V <sub>DRM</sub> =600V			25	mA
Isolation resistance input to output		R <sub>iso</sub>	DC500V	10 <sup>10</sup>			Ω
Turn-on time		T <sub>on</sub>	60Hz AC			8.3	ms
Turn-off time		T <sub>off</sub>	60Hz AC			8.3	ms
Thermal resistance (between junction and case)		R <sub>th</sub> (j-c)1			1.3		°C/W