

2A Low Dropout Regulator with Enable

Features

- Adjustable Output from 1.2V to 4.8V Using External Resistors
- 1.5V, 1.8V and 2.5V options by Setting ADJ Pin Below 0.2V
- Over current and over temperature protection
- 500mV dropout @2A
- Enable pin
- 10μA quiescent current in shutdown
- Output recovery mode in OTP
- Connect ADJ to GND for fixed output mode
- TO-252-5 Package

Applications

- Battery powered systems
- Motherboards
- Peripheral cards
- Set Top Boxes
- Notebook Computers

Ordering Information

ORDER NUMBER	ORDER NUMBER (Pb free)	MARKING	TEMP. RANGE	PACKAGE
G962-15ADJTJU	G962-15ADJTJUf	G962-15	-40°C ~ +85°C	TO-252-5
G962-18ADJTJU	G962-18ADJTJUf	G962-18	-40°C ~ +85°C	TO-252-5
G962-25ADJTJU	G962-25ADJTJUf	G962-25	-40°C ~ +85°C	TO-252-5

Note: TJ:TO-252-5

U : Tape & Reel

e.g. 18 denotes the 1.8V output voltage.

General Description

The G962 is a high performance positive voltage regulator designed for use in applications requiring very low dropout voltage at up to 2 Amps. Since it has superior dropout characteristics compared to regular LDOs, it can be used to supply 2.5V on motherboards or 1.5V, 1.8V on peripheral cards from the 3.3V supply thus allowing the elimination of costly heatsinks. An enable pin further reduces power dissipation while shut down. The G962 provides excellent regulation over variations in line, load and temperature.

The TO-252-5 is available with 1.5V, 1.8V and 2.5V internally preset outputs that are also adjustable using external resistors.

Pin Configuration

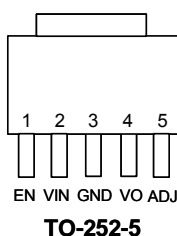

Typical Application Circuit

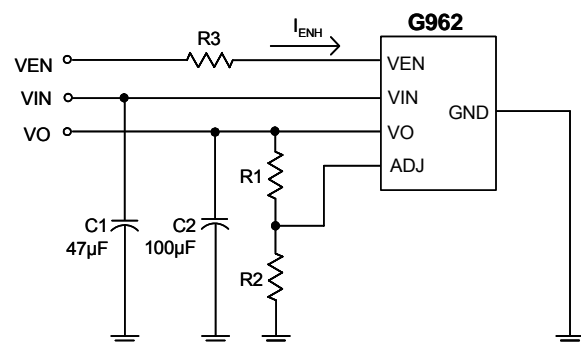

$$VO = \frac{1.2 (R1+R2)}{R2} \text{ Volts}$$

R2=12kΩ is recommended

R3 should be connected for current I_{ENH} restriction as $V_{EN} > V_{IN} + 0.3V$



Absolute Maximum Ratings	(Note 1)
Input Voltage.....	7V
V _{EN} Voltage.....	V _{IN} +0.3V
Power Dissipation Internally Limited	(Note 2)
Maximum Junction Temperature.....	150°C
Storage Temperature Range.....	-65°C ≤ T _J ≤ +150°C
Reflow Temperature (Soldering, 10 sec).....	260°C
Thermal Resistance Junction to Ambient, (θ _{JA})	
TO-252-5.....	95°C/W
Thermal Resistance Junction to Case, (θ _{JC})	
TO-252-5.....	8°C/W
ESD Rating (Human Body Model).....	2kV

Operation Conditions	(Note 1)
Input Voltage.....	2.2V ~7V
Temperature Range.....	-40°C ≤ T _A ≤ +85°C

Electrical Characteristics

V_{EN}=V_{IN}, V_{IN}=5V, I_O=0.5A, C_{IN}=4.7μF, C_{OUT}=10μF, T_A=T_J=25°C unless otherwise specified (Note 3)

PARAMETER	SYMBOL	CONDITION	MIN	TYP	MAX	UNIT
Output Voltage	V _O	V _{IN} =V _O +0.7V, I _O =10mA	-2	V _O	2	%
Line Regulation		V _O +0.7V ≤ V _{IN} ≤ 5.5V, I _O =10mA	---	0.2	2	%
Load Regulation		10mA ≤ I _O ≤ 2A	---	0.8	2	%
Quiescent Current	I _Q	V _{IN} =3.3V, V _{EN} =V _{IN}	---	1.7	2.5	mA
		V _{IN} =3.3V, V _{EN} =0V	---	16	35	μA
Ripple Rejection		f _i =120Hz, 1V _{P-P} , I _O =100mA	---	55	---	dB
Dropout Voltage	V _D	I _O =2A	---	0.7	0.85	V
Short Circuit Current			---	0.8	---	A
Over Temperature		(Note 4)	---	150	---	°C
V _{EN} Voltage High	V _{ENH}	Output Active	1.6	---	---	V
V _{EN} Voltage Low	V _{ENL}	Output Disabled	---	---	0.4	V
V _{EN} Bias Current Low	I _{ENL}	V _{EN} =0.4V	---	---	20	μA
ADJ Reference Voltage	V _{REF}	V _{IN} =2.2V, V _{ADJ} =V _{OUT} , I _O =10mA	1.176	1.2	1.224	V
ADJ Pin Threshold			---	0.2	---	V

Note 1: Absolute Maximum Ratings are limits beyond which damage to the device may occur. Operating Conditions are conditions under which the device functions but the specifications might not be guaranteed. For guaranteed specifications and test conditions see the Electrical Characteristics.

Note2: The maximum power dissipation is a function of the maximum junction temperature, T_{Jmax}; total thermal resistance, θ_{JA}, and ambient temperature T_A. The maximum allowable power dissipation at any ambient temperature is (T_{Jmax}-T_A)/θ_{JA}. If this dissipation is exceeded, the die temperature will rise above 150°C and IC will go into thermal shutdown.

Note3: Low duty pulse techniques are used during test to maintain junction temperature as close to ambient as possible.

Note4: The over temperature point is guarantee by design.

Definitions

Dropout Voltage

The input/output voltage differential at which the regulator output no longer maintains regulation against further reductions in input voltage. Measured when the output drops 2% below its nominal value, dropout voltage is affected by junction temperature, load current and minimum input supply requirements.

Line Regulation

The change in output voltage for a change in input voltage. The measurement is made under conditions of low dissipation or by using pulse techniques such that average chip temperature is not significantly affected.

Load Regulation

The change in output voltage for a change in load

current at constant chip temperature. The measurement is made under conditions of low dissipation or by using pulse techniques such that average chip temperature is not significantly affected.

Maximum Power Dissipation

The maximum total device dissipation for which the regulator will operate within specifications.

Quiescent Bias Current

Current which is used to operate the regulator chip and is not delivered to the load.

Output Capacitor for Stable Condition

The G962 can be stable for X5R MLCC capacitor larger than 10μF or POSCAP capacitor larger than 47μF.

Typical Characteristics

$V_{EN}=V_{IN}$, $=5V$, $I_O = 0.5A$, $C_{IN} = 4.7\mu F$, $C_{OUT} = 10\mu F$, $T_A = T_J = 25^\circ C$
 ($V_{OUT}=1.8V$)

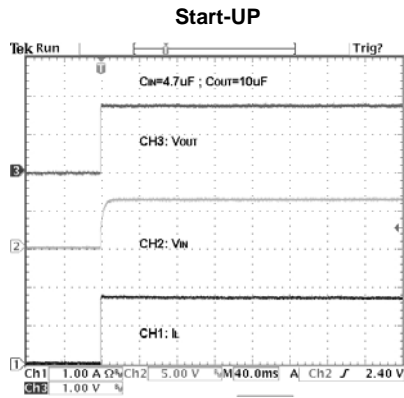
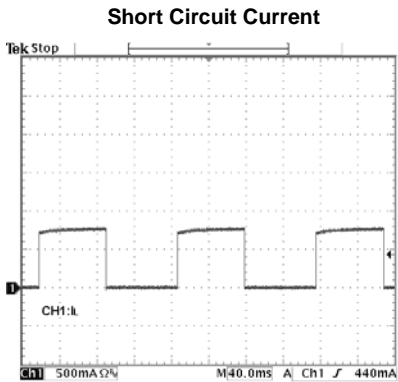
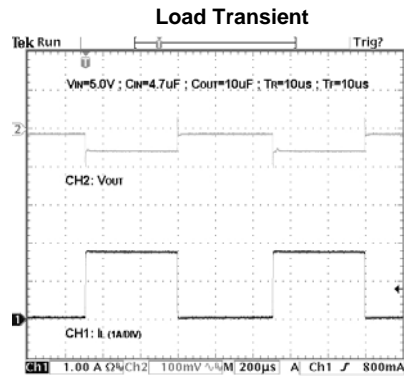
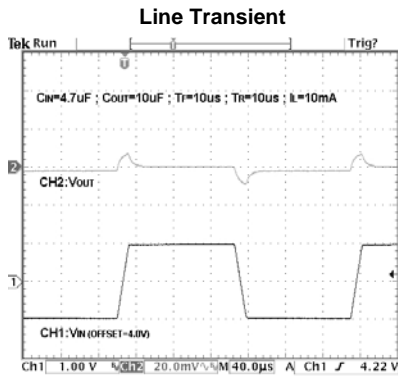

Overcurrent Protection Characteristics

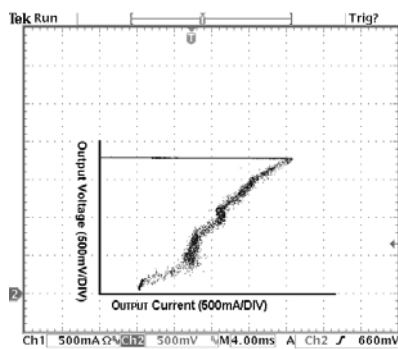

Ripple Rejection

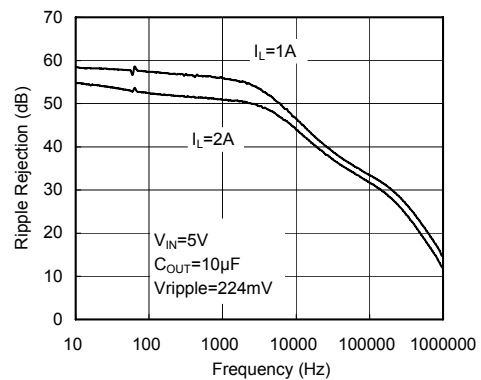

Typical Characteristics (continued)

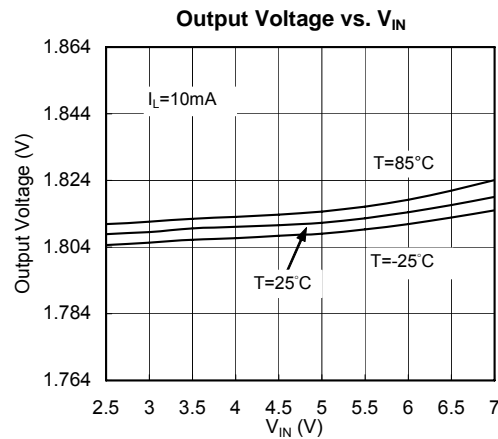
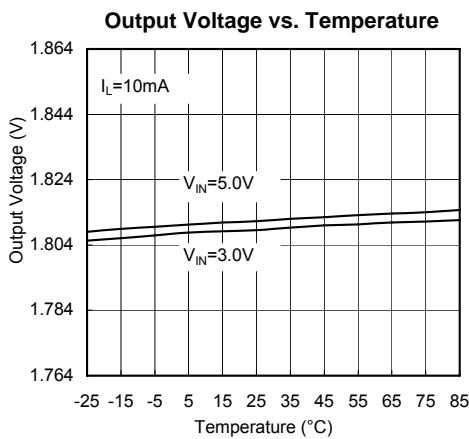
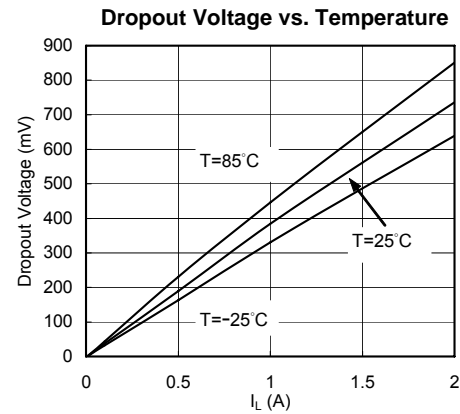
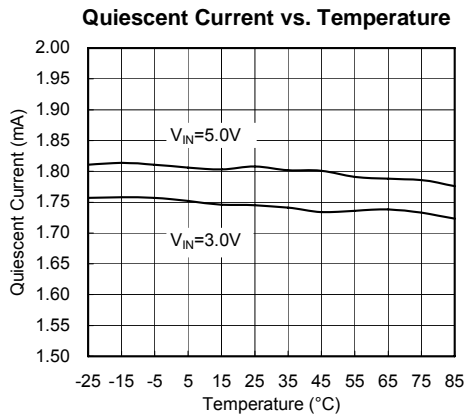
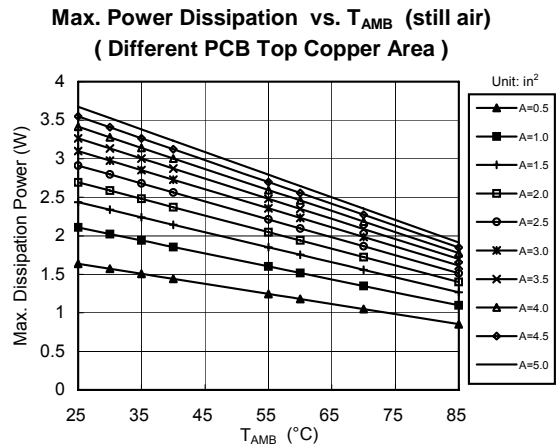
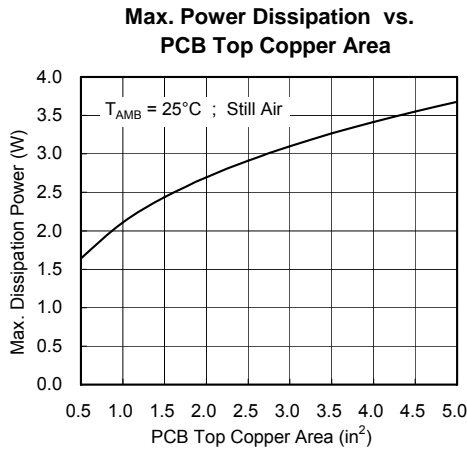

Recommend Minimum Footprint

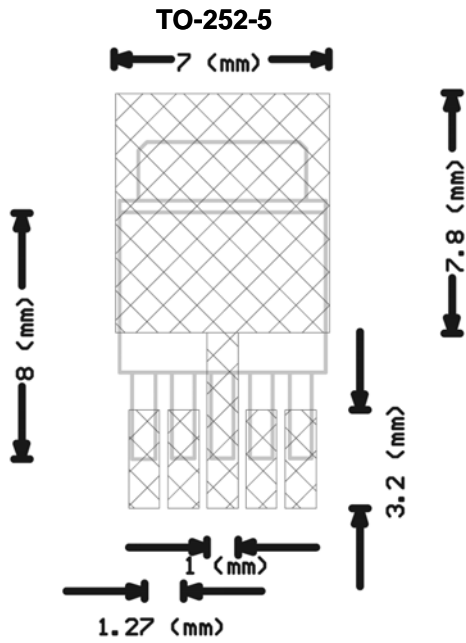

Package Information

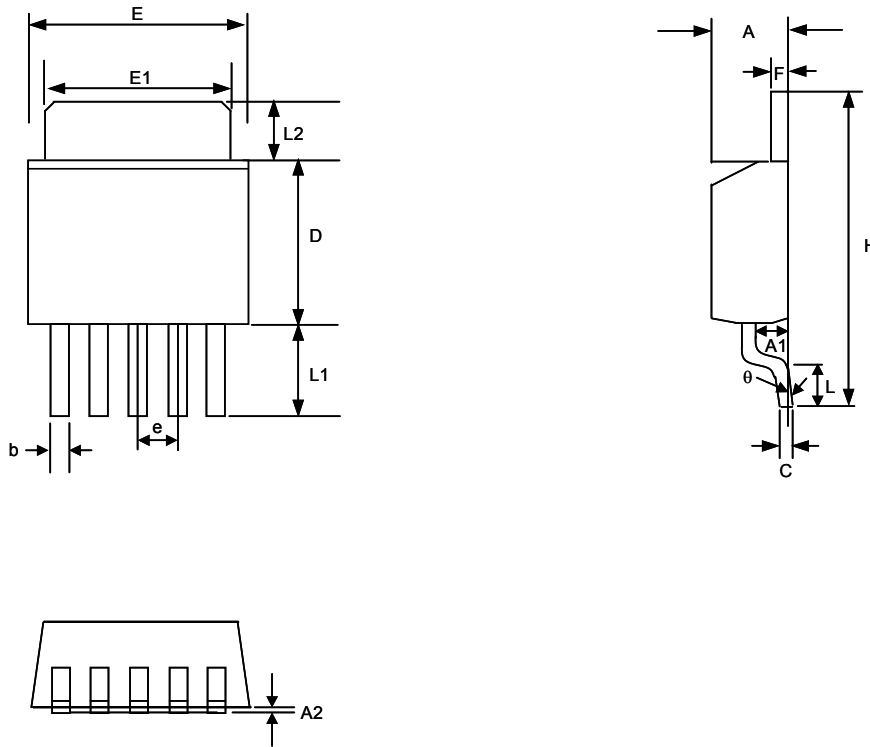

TO-252-5 (TJ) Package

SYMBOL	MILLIMETER		INCH	
	MIN.	MAX.	MIN.	MAX.
A	2.19	2.38	0.086	0.094
A1	0.89	1.27	0.035	0.050
b	0.64	0.89	0.025	0.035
C	0.46	0.58	0.018	0.023
D	5.36	5.61	0.211	0.221
E	6.35	6.73	0.250	0.265
E1	5.21	5.46	0.205	0.215
e	1.27BSC		0.050BSC	
F	0.46	0.58	0.018	0.023
L	1.40	1.78	0.055	0.070
L1	2.20	2.80	0.087	0.110
L2	1.52	2.03	0.060	0.080
H	9.40	10.40	0.370	0.410
θ	0°	4°	0°	4°

Taping Specification

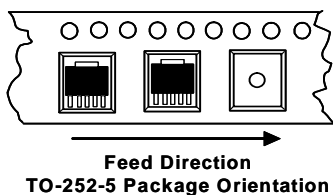

PACKAGE	Q'TY/REEL
TO-252-5	2,500 ea

GMT Inc. does not assume any responsibility for use of any circuitry described, no circuit patent licenses are implied and GMT Inc. reserves the right at any time without notice to change said circuitry and specifications.