

FIN1001 3.3V LVDS 1-Bit High Speed Differential Driver

General Description

This single driver is designed for high speed interconnects utilizing Low Voltage Differential Signaling (LVDS) technology. The driver translates LVTTTL signal levels to LVDS levels with a typical differential output swing of 350 mV which provides low EMI at ultra low power dissipation even at high frequencies. This device is ideal for high speed transfer of clock or data.

The FIN1001 can be paired with its companion receiver, the FIN1002, or with any other LVDS receiver.

Features

- Greater than 600Mbps data rate
- 3.3V power supply operation
- 0.5ns maximum differential pulse skew
- 1.5ns maximum propagation delay
- Low power dissipation
- Power-Off protection
- Meets or exceeds the TIA/EIA-644 LVDS standard
- Flow-through pinout simplifies PCB layout
- 5-Lead SOT23 package saves space

Ordering Code:

Order Number	Package Number	Package Description
FIN1001M5	MA05B	5-Lead SOT23, JEDEC MO-178, 1.6mm [250 Units on Tape and Reel]
FIN1001M5X	MA05B	5-Lead SOT23, JEDEC MO-178, 1.6mm [3000 Units on Tape and Reel]

Pin Descriptions

Pin Name	Description
D _{IN}	LVTTTL Data Input
D _{OUT+}	Non-inverting LVDS Driver Output
D _{OUT-}	Inverting LVDS Driver Output
V _{CC}	Power Supply
GND	Ground
NC	No Connect

Function Table

Input	Outputs	
D _{IN}	D _{OUT+}	D _{OUT-}
L	L	H
H	H	L

H = HIGH Logic Level L = LOW Logic Level

Connection Diagram

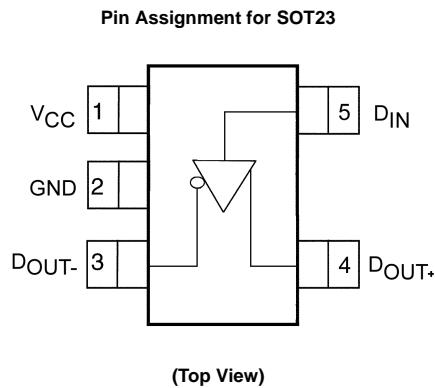

Absolute Maximum Ratings(Note 1)

Supply Voltage (V_{CC})	-0.5V to +4.6V
DC Input Voltage (D_{IN})	-0.5V to +6V
DC Output Voltage (D_{OUT})	-0.5V to +4.6V
Driver Short Circuit Current (I_{OSD})	Continuous
Storage Temperature Range (T_{STG})	-65°C to +150°C
Max Junction Temperature (T_J)	150°C
Lead Temperature (T_L) (Soldering, 10 seconds)	260°C
ESD (Human Body Model)	≥ 7500V
ESD (Machine Model)	≥ 400V

Recommended Operating Conditions

Supply Voltage (V_{CC})	3.0V to 3.6V
Input Voltage (V_{IN})	0 to V_{CC}
Operating Temperature (T_A)	-40°C to +85°C

Note 1: The "Absolute Maximum Ratings": are those values beyond which damage to the device may occur. The databook specifications should be met, without exception, to ensure that the system design is reliable over its power supply, temperature and output/input loading variables. Fairchild does not recommend operation of circuits outside databook specification.

DC Electrical Characteristics

Over supply voltage and operating temperature ranges, unless otherwise specified

Symbol	Parameter	Test Conditions	Min	Typ (Note 2)	Max	Units
V_{OD}	Output Differential Voltage	$R_L = 100 \Omega$, See Figure 1	250	350	450	mV
ΔV_{OD}	V_{OD} Magnitude Change from Differential LOW-to-HIGH				25	mV
V_{OS}	Offset Voltage		1.125	1.25	1.375	V
ΔV_{OS}	Offset Magnitude Change from Differential LOW-to-HIGH				25	mV
I_{OFF}	Power-Off Output Current	$V_{CC} = 0V$, $V_{OUT} = 0V$ or 3.6V			±20	µA
I_{OS}	Short Circuit Output Current	$V_{OUT} = 0V$		-5.5	-8	mA
		$V_{OD} = 0V$		±4	±8	
V_{IH}	Input HIGH Voltage		2.0		V_{CC}	V
V_{IL}	Input LOW Voltage		GND		0.8	V
I_{IN}	Input Current	$V_{IN} = 0V$ or V_{CC}			±20	µA
$I_{I(OFF)}$	Power-Off Input Current	$V_{CC} = 0V$, $V_{IN} = 0V$ or 3.6V			±20	µA
V_{IK}	Input Clamp Voltage	$I_{IK} = -18$ mA	-1.5	-0.8		V
I_{CC}	Power Supply Current	No Load, $V_{IN} = 0V$ or V_{CC}		4.5	8	mA
		$R_L = 100 \Omega$, $V_{IN} = 0V$ or V_{CC}		6.5	10	
C_{IN}	Input Capacitance	$V_{CC} = 3.3V$		3.2		pF
C_{OUT}	Output Capacitance	$V_{CC} = 0V$		3.3		pF

Note 2: All typical values are at $T_A = 25^\circ\text{C}$ and with $V_{CC} = 3.3V$.

AC Electrical Characteristics

Over supply voltage and operating temperature ranges, unless otherwise specified

Symbol	Parameter	Test Conditions	Min	Typ (Note 3)	Max	Units	
t_{PLHD}	Differential Propagation Delay LOW-to-HIGH	$R_L = 100 \Omega$, $C_L = 10\text{pF}$, See Figure 2 and Figure 3	0.5	0.98	1.5	ns	
t_{PHLD}	Differential Propagation Delay HIGH-to-LOW		0.5	0.93	1.5	ns	
t_{TLHD}	Differential Output Rise Time (20% to 80%)		0.4	0.5	1.0	ns	
t_{THLD}	Differential Output Fall Time (80% to 20%)		0.4	0.5	1.0	ns	
$t_{SK(P)}$	Pulse Skew $ t_{PLH} - t_{PHL} $				0.05	0.5	ns
$t_{SK(PP)}$	Part-to-Part Skew (Note 4)					1.0	ns

Note 3: All typical values are at $T_A = 25^\circ\text{C}$ and with $V_{CC} = 3.3V$.

Note 4: $t_{SK(PP)}$ is the magnitude of the difference in propagation delay times between any specified terminals of two devices switching in the same direction (either LOW-to-HIGH or HIGH-to-LOW) when both devices operate with the same supply voltage, same temperature, and have identical test circuits.

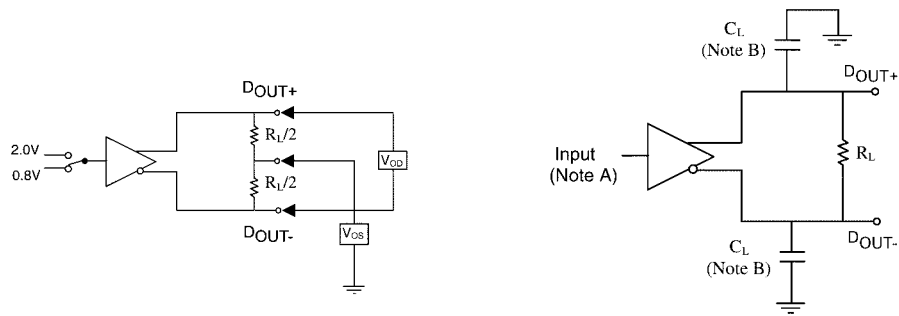

Note A: All input pulses have frequency = 10 MHz, t_r or $t_f = 2$ ns
Note B: C_L includes all probe and fixture capacitances

FIGURE 1. Differential Driver DC Test Circuit

FIGURE 2. Differential Driver Propagation Delay and Transition Time Test Circuit

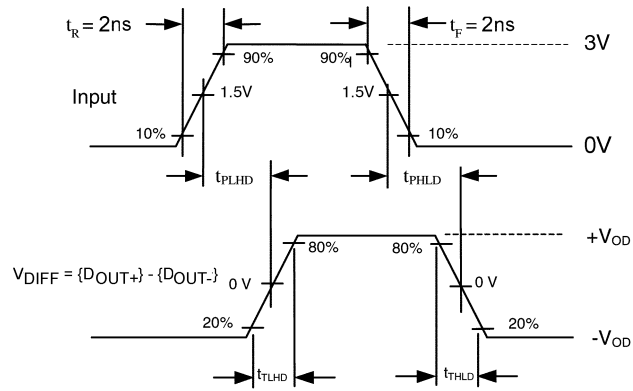

FIGURE 3. AC Waveforms

DC / AC Typical Performance Curves

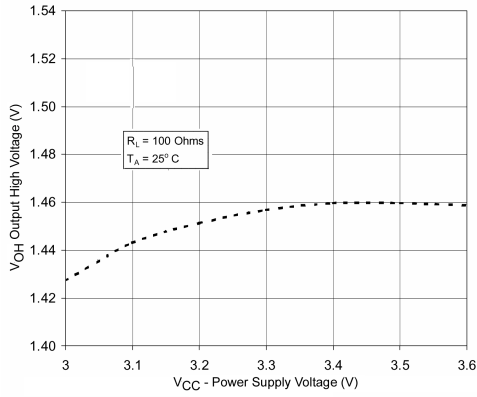

FIGURE 4. Output High Voltage vs. Power Supply Voltage

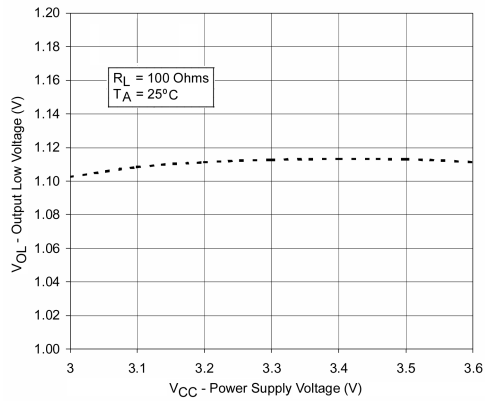

FIGURE 5. Output Low Voltage vs. Power Supply Voltage

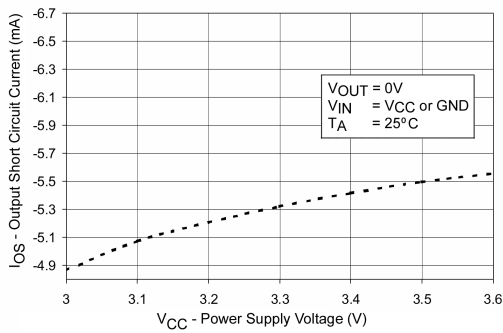

FIGURE 6. Output Short Circuit Current vs. Power Supply Voltage

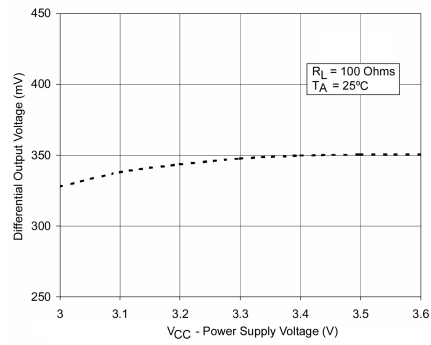

FIGURE 7. Differential Output Voltage vs. Power Supply Voltage

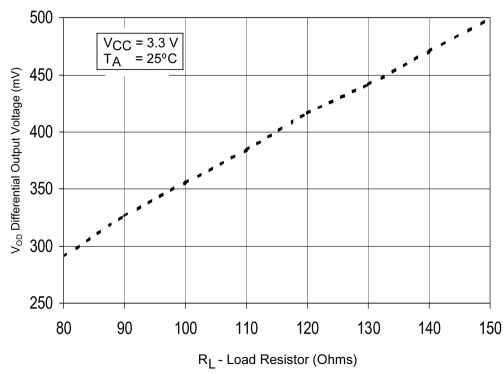

FIGURE 8. Differential Output Voltage vs. Load Resistor

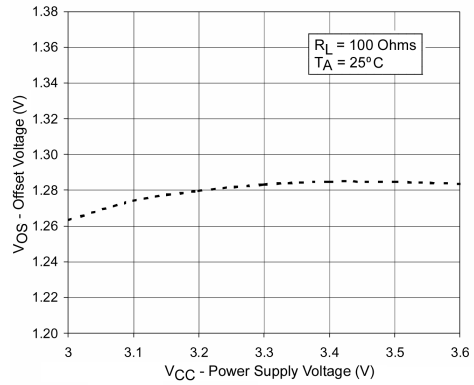

FIGURE 9. Offset Voltage vs. Power Supply Voltage

DC / AC Typical Performance Curves (Continued)

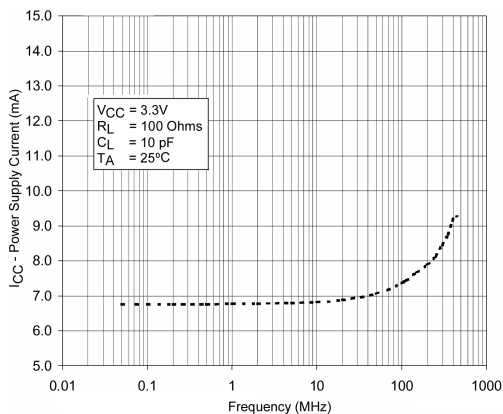

FIGURE 10. Power Supply Current vs. Frequency

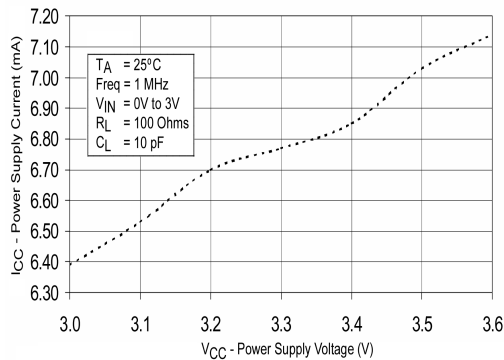

FIGURE 11. Power Supply Current vs. Power Supply Voltage

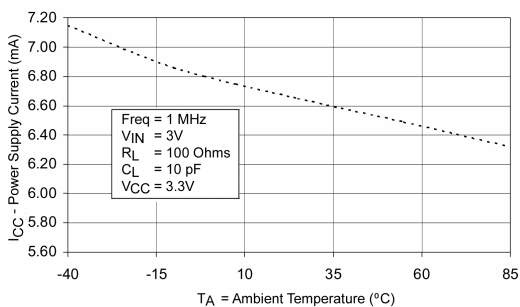

FIGURE 12. Power Supply Current vs. Ambient Temperature

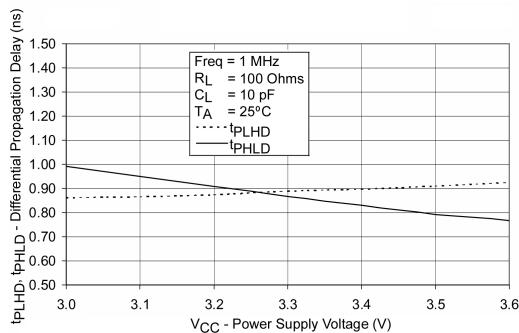

FIGURE 13. Differential Propagation Delay vs. Power Supply

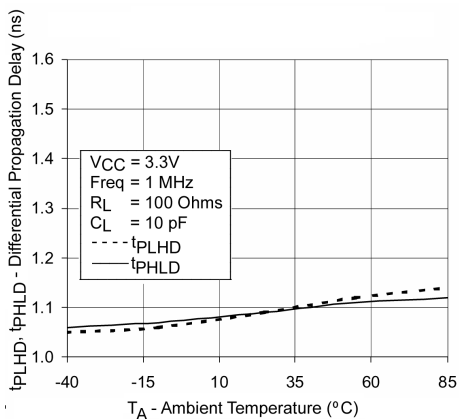

FIGURE 14. Differential Propagation Delay vs. Ambient Temperature

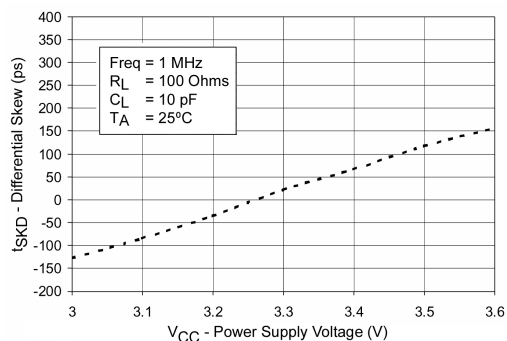

FIGURE 15. Differential Pulse Skew ($t_{PLH} - t_{PHL}$) vs. Power Supply Voltage

DC / AC Typical Performance Curves (Continued)

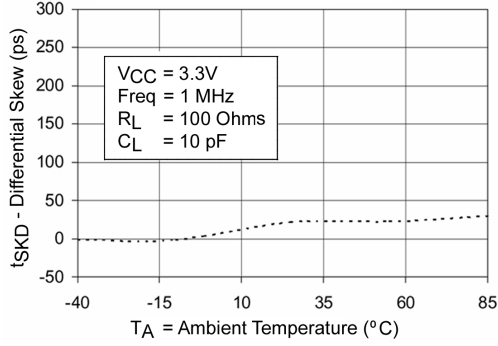

FIGURE 16. Differential Pulse Skew ($t_{PLH} - t_{PHL}$) vs. Ambient Temperature

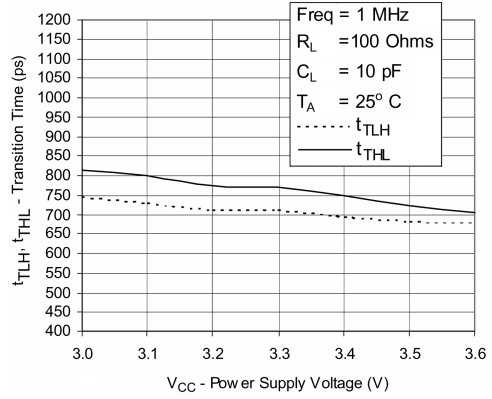

FIGURE 17. Transition Time vs. Power Supply Voltage

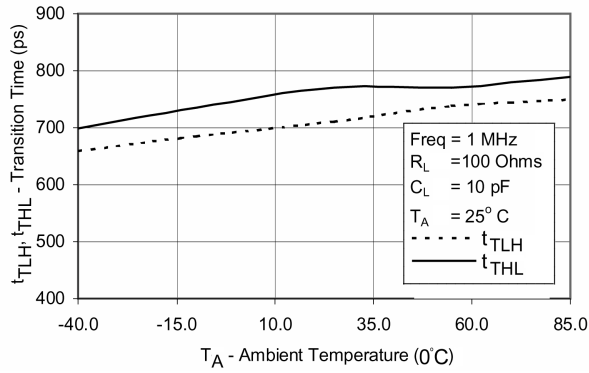
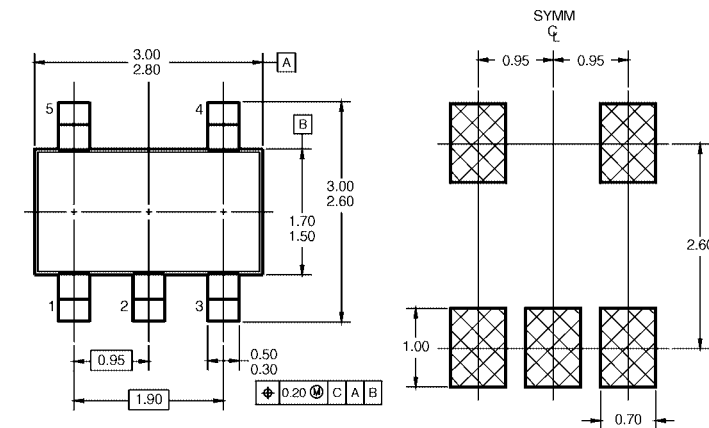
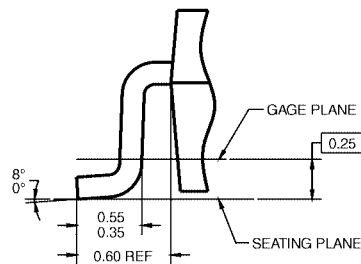
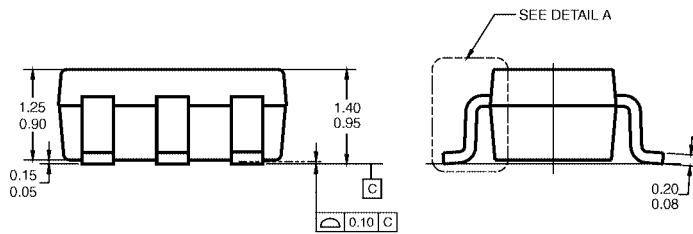

FIGURE 18. Transition Time vs. Ambient Temperature

Physical Dimensions inches (millimeters) unless otherwise noted



LAND PATTERN RECOMMENDATION



DETAIL A

NOTES: UNLESS OTHERWISE SPECIFIED
 A) THIS PACKAGE CONFORMS TO JEDEC MO-178, ISSUE B, VARIATION AA, DATED JANUARY 1999.
 B) ALL DIMENSIONS ARE IN MILLIMETERS.

MA05BRevC

**5-Lead SOT23, JEDEC MO-178, 1.6mm
 Package Number MA05B**

Fairchild does not assume any responsibility for use of any circuitry described, no circuit patent licenses are implied and Fairchild reserves the right at any time without notice to change said circuitry and specifications.

LIFE SUPPORT POLICY

FAIRCHILD'S PRODUCTS ARE NOT AUTHORIZED FOR USE AS CRITICAL COMPONENTS IN LIFE SUPPORT DEVICES OR SYSTEMS WITHOUT THE EXPRESS WRITTEN APPROVAL OF THE PRESIDENT OF FAIRCHILD SEMICONDUCTOR CORPORATION. As used herein:

1. Life support devices or systems are devices or systems which, (a) are intended for surgical implant into the body, or (b) support or sustain life, and (c) whose failure to perform when properly used in accordance with instructions for use provided in the labeling, can be reasonably expected to result in a significant injury to the user.
2. A critical component in any component of a life support device or system whose failure to perform can be reasonably expected to cause the failure of the life support device or system, or to affect its safety or effectiveness.

www.fairchildsemi.com