

1.4GHz Current Feedback Amplifiers with Enable

The EL5166 and EL5167 amplifiers are of the current feedback variety and exhibit a very high bandwidth of 1.4GHz at $A_V = +1$ and 800MHz at $A_V = +2$. This makes these amplifiers ideal for today's high speed video and monitor applications, as well as a number of RF and IF frequency designs.

With a supply current of just 8.5mA and the ability to run from a single supply voltage from 5V to 12V, these amplifiers offer very high performance for little power consumption.

The EL5166 also incorporates an enable and disable function to reduce the supply current to 13 μ A typical per amplifier. Allowing the CE pin to float or applying a low logic level will enable the amplifier.

The EL5167 is offered in the 5-pin SOT-23 package and the EL5166 is available in the 6-pin SOT-23 as well as the industry-standard 8-pin SO packages. Both operate over the industrial temperature range of -40°C to +85°C.

Features

- Gain-of-1 bandwidth = 1.4GHz/gain-of-2 bandwidth = 800MHz
- 6000V/ μ s slew rate
- Single and dual supply operation from 5V to 12V
- Low noise = 1.5nV/ \sqrt Hz
- 8.5mA supply current
- Fast enable/disable (EL5166 only)
- 600MHz family - (EL5164 and EL5165)
- 400MHz family - (EL5162 and EL5163)
- 200MHz family - (EL5160 and EL5161)
- Pb-free plus anneal available (RoHS compliant)

Applications

- Video amplifiers
- Cable drivers
- RGB amplifiers
- Test equipment
- Instrumentation
- Current to voltage converters

Pinouts

**EL5166
(8-PIN SO)
TOP VIEW**

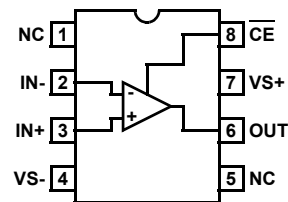

**EL5166
(6-PIN SOT-23)
TOP VIEW**

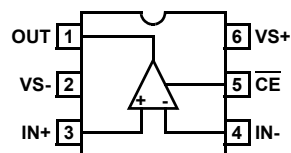

**EL5167
(5-PIN SOT-23, SC-70)
TOP VIEW**

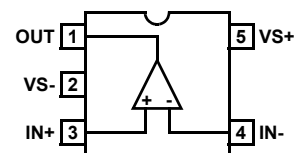

Ordering Information

PART NUMBER	PACKAGE	TAPE & REEL	PKG. DWG. #
EL5166IS	8-Pin SO	-	MDP0027
EL5166IS-T7	8-Pin SO	7"	MDP0027
EL5166IS-T13	8-Pin SO	13"	MDP0027
EL5166ISZ (See Note)	8-Pin SO (Pb-free)	-	MDP0027
EL5166ISZ-T7 (See Note)	8-Pin SO (Pb-free)	7"	MDP0027
EL5166ISZ-T13 (See Note)	8-Pin SO (Pb-free)	13"	MDP0027
EL5166IW-T7	6-Pin SOT-23	7" (3K pcs)	MDP0038
EL5166IW-T7A	6-Pin SOT-23	7" (250 pcs)	MDP0038
EL5166IWZ-T7 (See Note)	6-Pin SOT-23 (Pb-free)	7" (3K pcs)	MDP0038
EL5166IWZ-T7A (See Note)	6-Pin SOT-23 (Pb-free)	7" (250 pcs)	MDP0038
EL5167IC-T7	5-Pin SC-70	7" (3K pcs)	P5.049
EL5167IC-T7A	5-Pin SC-70	7" (250 pcs)	P5.049
EL5167ICZ-T7 (See Note)	5-Pin SC-70 (Pb-free)	7" (3K pcs)	P5.049
EL5167ICZ-T7A (See Note)	5-Pin SC-70 (Pb-free)	7" (250 pcs)	P5.049
EL5167IW-T7	5-Pin SOT-23	7" (3K pcs)	MDP0038
EL5167IW-T7A	5-Pin SOT-23	7" (250 pcs)	MDP0038
EL5167IWZ-T7 (See Note)	5-Pin SOT-23 (Pb-free)	7" (3K pcs)	MDP0038
EL5167IWZ-T7A (See Note)	5-Pin SOT-23 (Pb-free)	7" (250 pcs)	MDP0038

NOTE: Intersil Pb-free products employ special Pb-free material sets; molding compounds/die attach materials and 100% matte tin plate termination finish, which are RoHS compliant and compatible with both SnPb and Pb-free soldering operations. Intersil Pb-free products are MSL classified at Pb-free peak reflow temperatures that meet or exceed the Pb-free requirements of IPC/JEDEC J STD-020.

EL5166, EL5167

Absolute Maximum Ratings (T_A = 25°C)

Supply Voltage between V _{S+} and V _{S-} 12.6V	Power Dissipation See Curves
Slewrates between V _{S+} and V _{S-} 1V/μs	Pin Voltages V _{S-} -0.5V to V _{S+} +0.5V
Maximum Continuous Output Current 50mA	Storage Temperature -65°C to +150°C
I _{OUT} ±200mA	Ambient Operating Temperature -40°C to +85°C
I into V _{IN+} , V _{IN-} , Enable Pins ±4mA	Die Junction Temperature 125°C

CAUTION: Stresses above those listed in "Absolute Maximum Ratings" may cause permanent damage to the device. This is a stress only rating and operation of the device at these or any other conditions above those indicated in the operational sections of this specification is not implied.

IMPORTANT NOTE: All parameters having Min/Max specifications are guaranteed. Typical values are for information purposes only. Unless otherwise noted, all tests are at the specified temperature and are pulsed tests, therefore: T_J = T_C = T_A

Electrical Specifications V_{S+} = +5V, V_{S-} = -5V, R_F = 392Ω for A_V = 1, R_F = 250Ω for A_V = 2, R_L = 150Ω, T_A = 25°C Unless Otherwise Specified.

PARAMETER	DESCRIPTION	CONDITIONS	MIN	TYP	MAX	UNIT
AC PERFORMANCE						
BW	-3dB Bandwidth	A _V = +1		1400		MHz
		A _V = +2		800		MHz
BW1	0.1dB Bandwidth	A _V = +2		100		MHz
SR	Slew Rate	V _O = -2.5V to +2.5V, A _V = +2	4000	6000		V/μs
t _S	0.1% Settling Time	V _{OUT} = -2.5V to +2.5V, A _V = -1		8		ns
e _N	Input Voltage Noise			1.7		nV/√Hz
i _{IN-}	IN- Input Current Noise			19		pA/√Hz
i _{IN+}	IN+ Input Current Noise			50		pA/√Hz
dG	Differential Gain Error (Note 1)	A _V = +2		0.01		%
dP	Differential Phase Error (Note 1)	A _V = +2		0.03		°
DC PERFORMANCE						
V _{OS}	Offset Voltage		-5	-0.5	5	mV
T _C V _{OS}	Input Offset Voltage Temperature Coefficient	Measured from T _{MIN} to T _{MAX}		3.52		μV/°C
R _{OL}	Transimpedance		0.5	1.1	2.5	MΩ
INPUT CHARACTERISTICS						
CMIR	Common Mode Input Range (guaranteed by CMRR test)		±3	±3.3		V
CMRR	Common Mode Rejection Ratio		52	57	66	dB
-ICMR	- Input Current Common Mode Rejection		-1	0.7	1	μA/V
+I _{IN}	+ Input Current		-25	0.7	25	μA
-I _{IN}	- Input Current		-25	8.5	25	μA
R _{IN}	Input Resistance		50	130	250	kΩ
C _{IN}	Input Capacitance			1.5		pF
OUTPUT CHARACTERISTICS						
V _O	Output Voltage Swing	R _L = 150Ω to GND	±3.6	±3.8	±4.1	V
		R _L = 1kΩ to GND	±3.8	±4.0	±4.2	V
I _{OUT}	Output Current	R _L = 10Ω to GND	±110	±160	±200	mA

EL5166, EL5167

Electrical Specifications $V_{S+} = +5V$, $V_{S-} = -5V$, $R_F = 392\Omega$ for $A_V = 1$, $R_F = 250\Omega$ for $A_V = 2$, $R_L = 150\Omega$, $T_A = 25^\circ C$
 Unless Otherwise Specified. (Continued)

PARAMETER	DESCRIPTION	CONDITIONS	MIN	TYP	MAX	UNIT
SUPPLY						
I_{SON}	Supply Current - Enabled	No load, $V_{IN} = 0V$	7.5	8.5	9.3	mA
I_{SOFF+}	Supply Current - Disabled	No load, $V_{IN} = 0V$	1	4	25	μA
I_{SOFF-}	Supply Current - Disabled	No load, $V_{IN} = 0V$	-25	-14	-1	μA
PSRR	Power Supply Rejection Ratio	DC, $V_S = \pm 4.75V$ to $\pm 5.25V$	70	50		dB
-IPSR	- Input Current Power Supply Rejection	DC, $V_S = \pm 4.75V$ to $\pm 5.25V$	-0.5	0.2	1	$\mu A/V$
ENABLE (EL5166 ONLY)						
t_{EN}	Enable Time			170		ns
t_{DIS}	Disable Time			1.25		μs
I_{IHCE}	\overline{CE} Pin Input High Current	$\overline{CE} = V_{S+}$		0	-1	μA
I_{ILCE}	\overline{CE} Pin Input Low Current	$\overline{CE} = V_{S-}$	1	13	25	μA
V_{IHCE}	\overline{CE} Input High Voltage for Power-down		$V_{S+} - 1$			V
V_{ILCE}	\overline{CE} Input Low Voltage for Power-down				$V_{S+} - 3$	V

NOTE:

- Standard NTSC test, AC signal amplitude = 286mV, $f = 3.58MHz$.

Typical Performance Curves

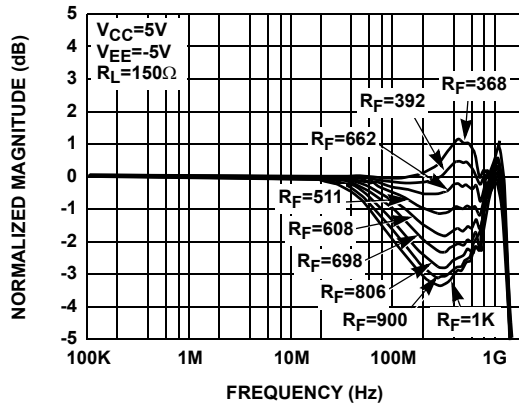

FIGURE 1. FREQUENCY RESPONSE AS THE FUNCTION OF R_F

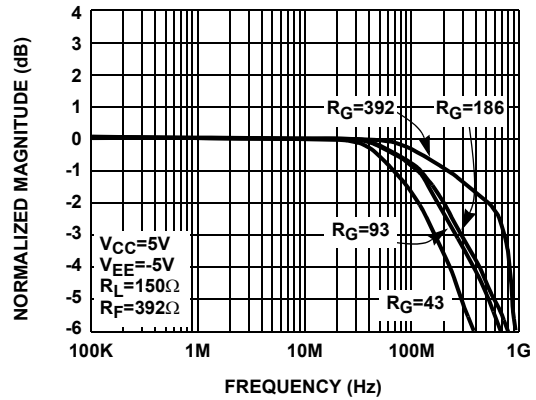

FIGURE 2. FREQUENCY RESPONSE AS THE FUNCTION OF THE GAIN

Typical Performance Curves (Continued)

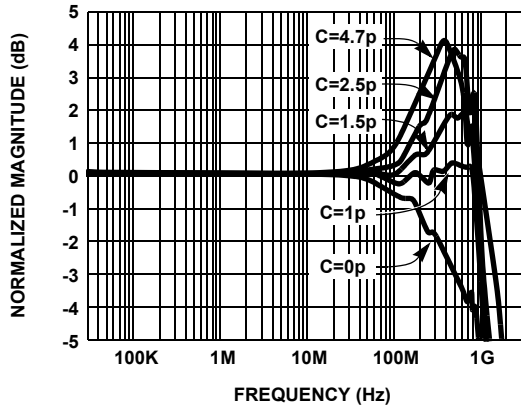

FIGURE 3. FREQUENCY RESPONSE vs C_{IN}

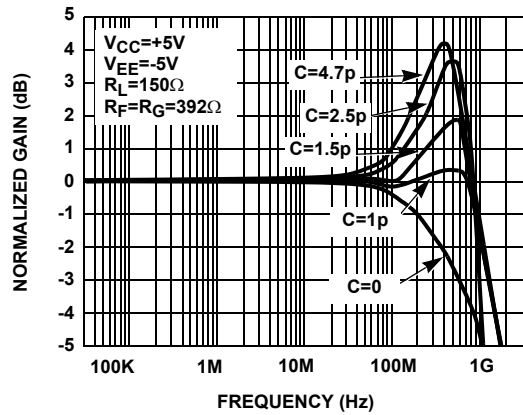

FIGURE 4. NON-INVERTING FREQUENCY RESPONSE FOR VARIOUS C_{IN} (6-PIN SOT-23)

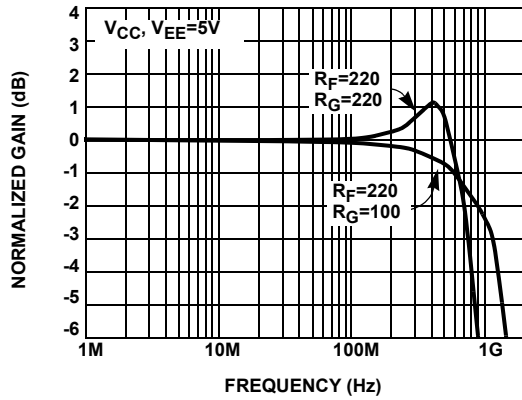

FIGURE 5. INVERTING FREQUENCY RESPONSE FOR GAIN OF 1 AND 2

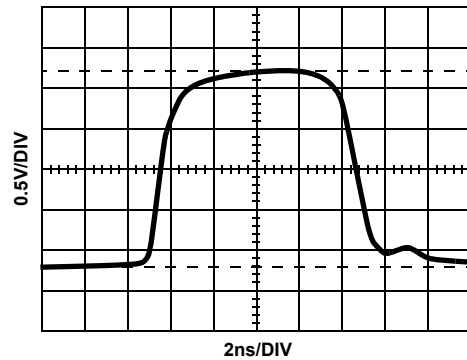

FIGURE 6. RISE AND FALL TIME (6-PIN SOT-23)

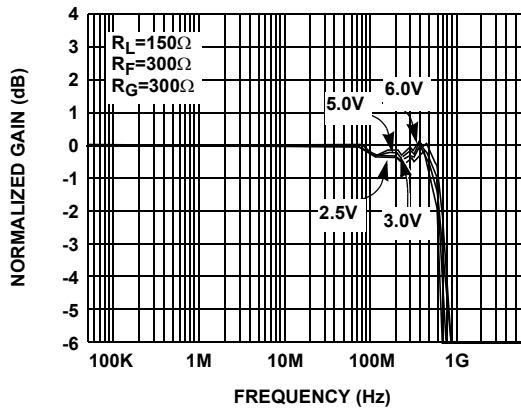

FIGURE 7. FREQUENCY RESPONSE AS THE FUNCTION OF THE POWER SUPPLY VOLTAGE

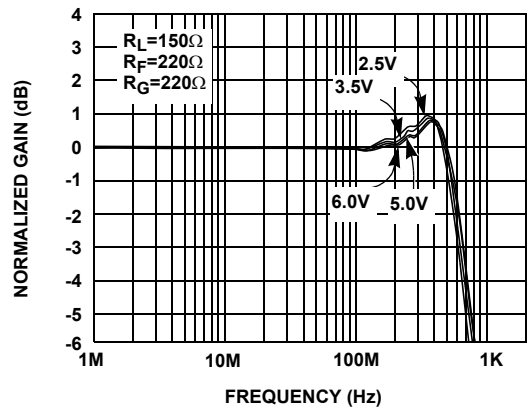

FIGURE 8. INVERTING AMPLIFIER, FREQUENCY RESPONSE AS THE FUNCTION OF V_{CC} , V_{EE} GAIN - 1

Typical Performance Curves (Continued)

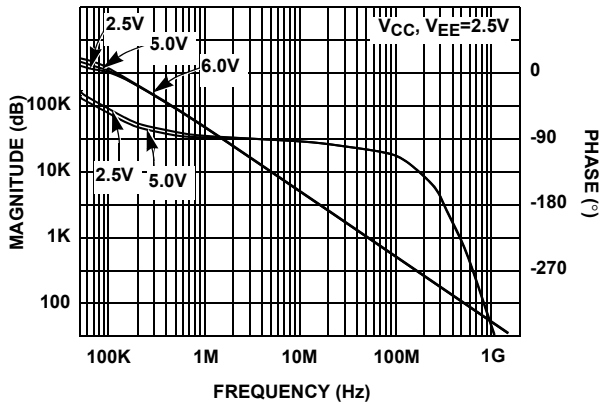

FIGURE 9. TRANSIMPEDANCE MAGNITUDE AND PHASE AS THE FUNCTION OF THE FREQUENCY

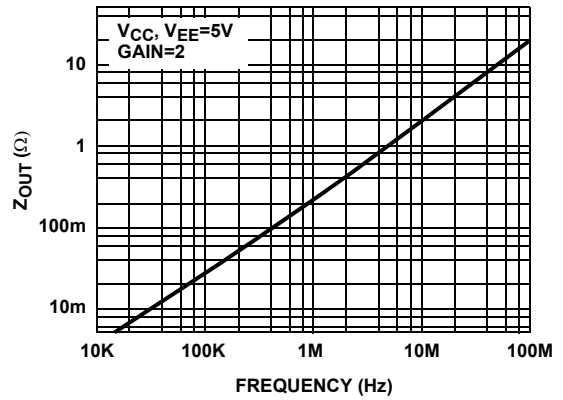

FIGURE 10. CLOSED LOOP OUTPUT IMPEDANCE vs FREQUENCY (6-PIN SOT-23)

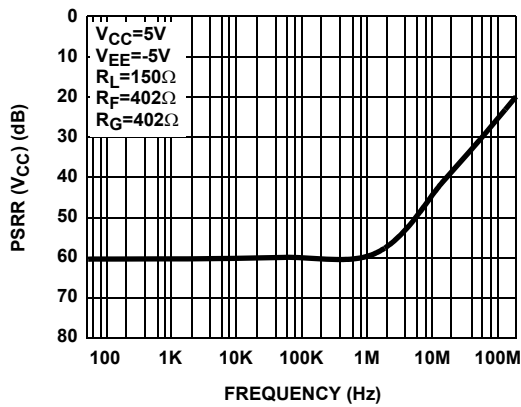

FIGURE 11. PSRR +5V

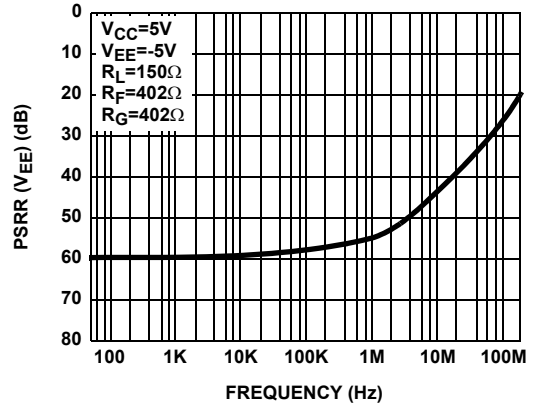

FIGURE 12. PSRR -5V

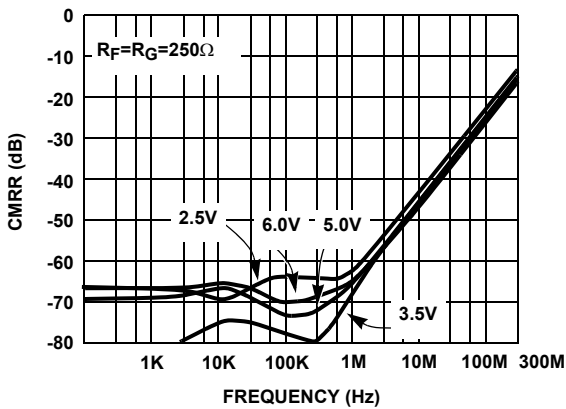

FIGURE 13. COMMON MODE REJECTION AS THE FUNCTION OF THE FREQUENCY AND POWER SUPPLY VOLTAGE

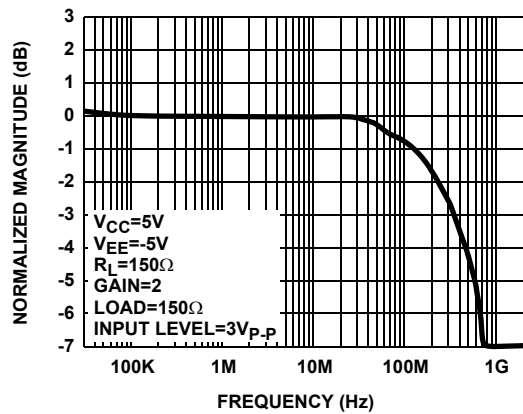

FIGURE 14. LARGE SIGNAL RESPONSE

Typical Performance Curves (Continued)

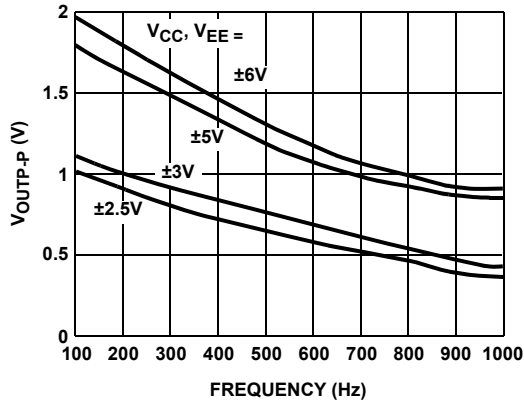

FIGURE 15. T_{OUT} vs FREQUENCY AND V_{CC} , V_{EE}

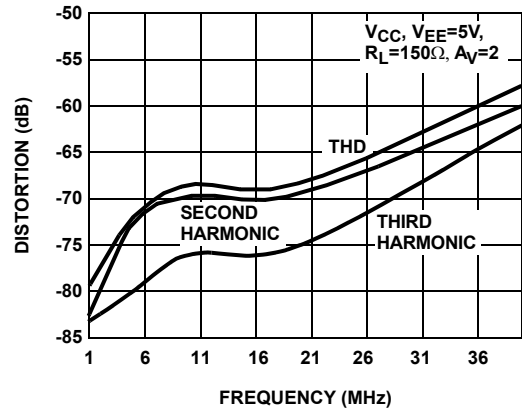

FIGURE 16. DISTORTION vs FREQUENCY

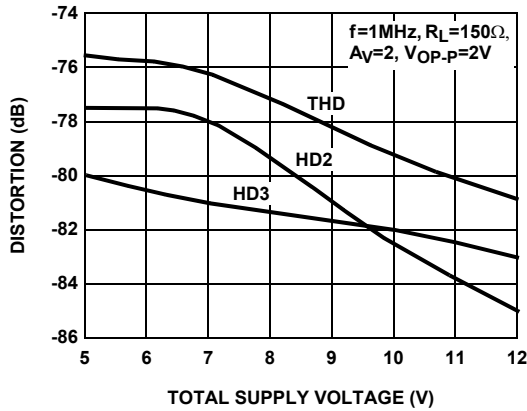

FIGURE 17. HARMONIC DISTORTION vs SUPPLY VOLTAGE

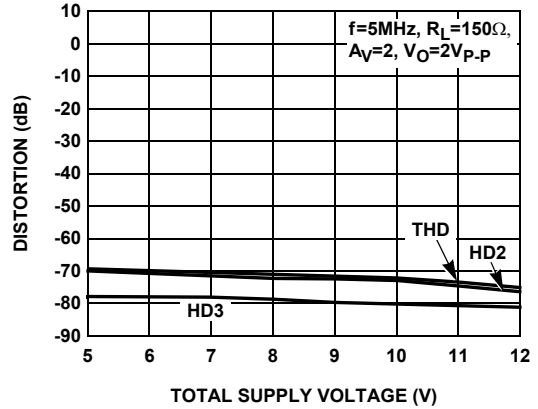

FIGURE 18. HARMONIC DISTORTION vs SUPPLY VOLTAGE

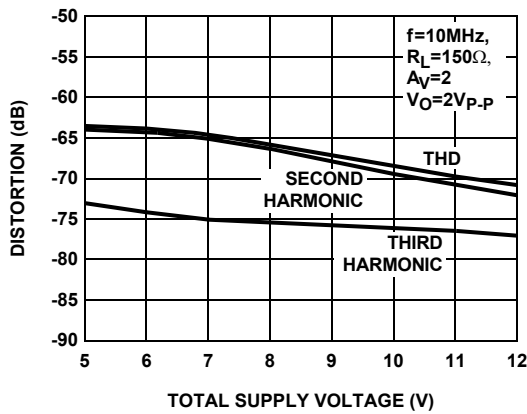

FIGURE 19. DISTORTION vs POWER SUPPLY VOLTAGE

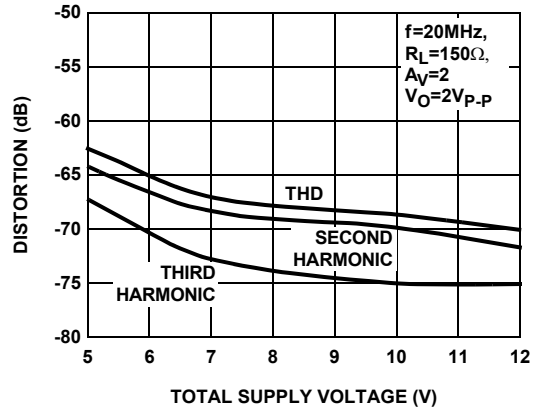

FIGURE 20. DISTORTION vs POWER SUPPLY VOLTAGE (EL5166)

Typical Performance Curves (Continued)

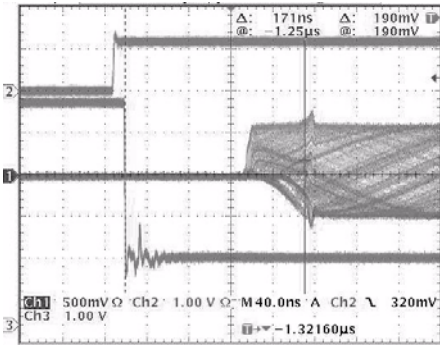

FIGURE 21. TURN ON TIME (EL5166)

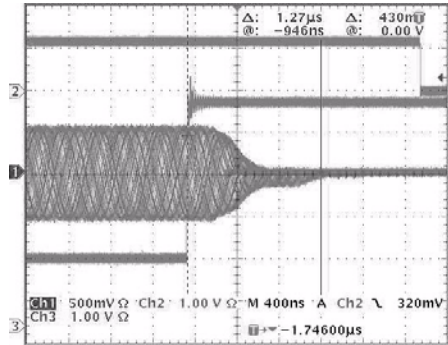

FIGURE 22. TURN OFF TIME (EL5166)

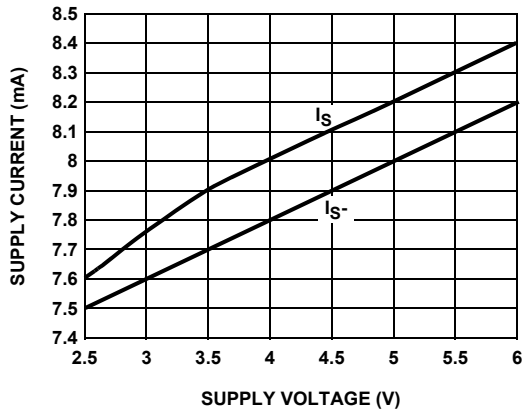

FIGURE 23. SUPPLY CURRENT vs SUPPLY VOLTAGE (EL5166)

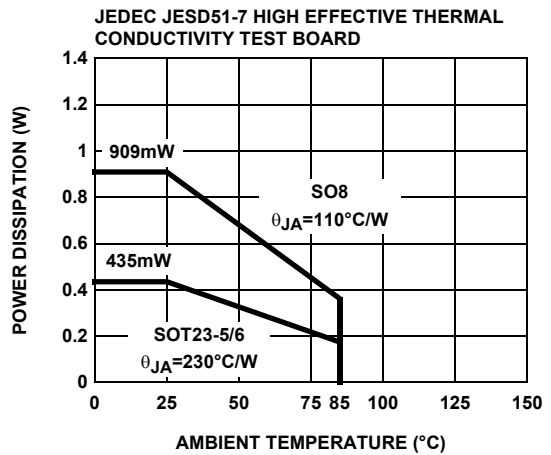

FIGURE 24. PACKAGE POWER DISSIPATION vs AMBIENT TEMPERATURE

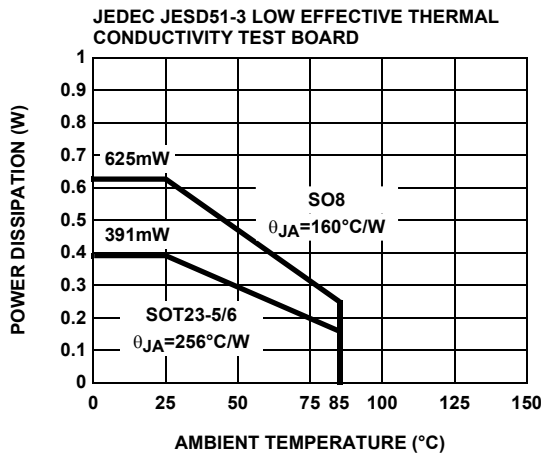
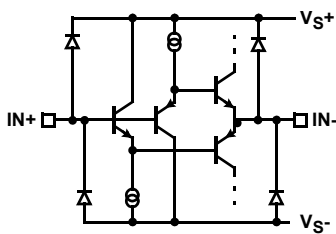
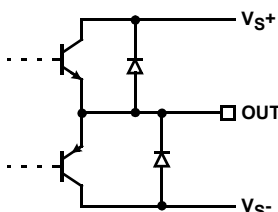
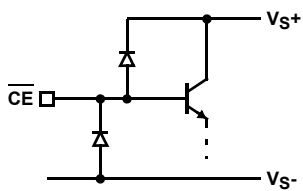

FIGURE 25. PACKAGE POWER DISSIPATION vs AMBIENT TEMPERATURE

Pin Descriptions

8-PIN SO	6-PIN SOT-23	5-PIN SOT-23	PIN NAME	FUNCTION	EQUIVALENT CIRCUIT
1, 5			NC	Not connected	
2	4	4	IN-	Inverting input	 <p style="text-align: center;">CIRCUIT 1</p>
3	3	3	IN+	Non-inverting input	(See circuit 1)
4	2	2	VS-	Negative supply	
6	1	1	OUT	Output	 <p style="text-align: center;">CIRCUIT 2</p>
7	6	5	VS+	Positive supply	
8	5		$\overline{\text{CE}}$	Chip enable	 <p style="text-align: center;">CIRCUIT 3</p>

Applications Information

Product Description

The EL5166 and EL5167 are current-feedback operational amplifiers that offers a wide -3dB bandwidth of 1.4GHz and a low supply current of 8.5mA per amplifier. The EL5166 and EL5167 work with supply voltages ranging from a single 5V to 10V and they are also capable of swinging to within 1V of either supply on the output. Because of their current-feedback topology, the EL5166 and EL5167 do not have the normal gain-bandwidth product associated with voltage-feedback operational amplifiers. Instead, their -3dB bandwidth remains relatively constant as closed-loop gain is increased. This combination of high bandwidth and low power, together with aggressive pricing make the EL5166 and EL5167 ideal choices for many low-power/high-bandwidth applications such as portable, handheld, or battery-powered equipment.

Power Supply Bypassing and Printed Circuit Board Layout

As with any high frequency device, good printed circuit board layout is necessary for optimum performance. Low impedance ground plane construction is essential. Surface mount components are recommended, but if leaded components are used, lead lengths should be as short as possible. The power supply pins must be well bypassed to reduce the risk of oscillation. The combination of a 4.7 μ F tantalum capacitor in parallel with a 0.01 μ F capacitor has been shown to work well when placed at each supply pin.

For good AC performance, parasitic capacitance should be kept to a minimum, especially at the inverting input. (See the Capacitance at the Inverting Input section) Even when ground plane construction is used, it should be removed from the area near the inverting input to minimize any stray capacitance at that node. Carbon or Metal-Film resistors are acceptable with the Metal-Film resistors giving slightly less peaking and bandwidth because of additional series inductance. Use of sockets, particularly for the SO package, should be avoided if possible. Sockets add parasitic inductance and capacitance which will result in additional peaking and overshoot.

Disable/Power-Down

The EL5166 amplifier can be disabled placing its output in a high impedance state. When disabled, the amplifier supply current is reduced to 13 μ A. The EL5166 is disabled when its \overline{CE} pin is pulled up to within 1V of the positive supply. Similarly, the amplifier is enabled by floating or pulling its \overline{CE} pin to at least 3V below the positive supply. For ± 5 V supply, this means that an EL5166 amplifier will be enabled when \overline{CE} is 2V or less, and disabled when \overline{CE} is above 4V. Although the logic levels are not standard TTL, this choice of logic voltages allows the EL5166 to be enabled by tying \overline{CE} to ground, even in 5V single supply applications. The \overline{CE} pin can be driven from CMOS outputs.

Capacitance at the Inverting Input

Any manufacturer's high-speed voltage- or current-feedback amplifier can be affected by stray capacitance at the inverting input. For inverting gains, this parasitic capacitance has little effect because the inverting input is a virtual ground. But for non-inverting gains, this capacitance (in conjunction with the feedback and gain resistors) creates a pole in the feedback path of the amplifier. This pole, if low enough in frequency, has the same destabilizing effect as a zero in the forward open-loop response. The use of large value feedback and gain resistors exacerbates the problem by further lowering the pole frequency (increasing the possibility of oscillation).

The EL5166 and EL5167 frequency responses are optimized with the resistor values in Figure 3. With the high bandwidth of these amplifiers, these resistor values might cause stability problems when combined with parasitic capacitance, thus ground plane is not recommended around the inverting input pin of the amplifier.

Feedback Resistor Values

The EL5166 and EL5167 have been designed and specified at a gain of +2 with R_F approximately 392 Ω . This value of feedback resistor gives 800MHz of -3dB bandwidth at $A_V = 2$ with about 0.5dB of peaking. Since the EL5166 and EL5167 are current-feedback amplifiers, it is also possible to change the value of R_F to get more bandwidth. As seen in the curve of Frequency Response for Various R_F and R_G , bandwidth and peaking can be easily modified by varying the value of the feedback resistor.

Because the EL5166 and EL5167 are current-feedback amplifiers, their gain-bandwidth product is not a constant for different closed-loop gains. This feature actually allows the EL5166 and EL5167 to maintain reasonable constant -3dB bandwidth for different gains. As gain is increased, bandwidth decreases slightly while stability increases. Since the loop stability is improving with higher closed-loop gains, it becomes possible to reduce the value of R_F below the specified 250 Ω and still retain stability, resulting in only a slight loss of bandwidth with increased closed-loop gain.

Supply Voltage Range and Single-Supply Operation

The EL5166 and EL5167 have been designed to operate with supply voltages having a span of greater than 5V and less than 10V. In practical terms, this means that the EL5166 and EL5167 will operate on dual supplies ranging from ± 2.5 V to ± 5 V. With single-supply, they will operate from 5V to 10V.

As supply voltages continue to decrease, it becomes necessary to provide input and output voltage ranges that can get as close as possible to the supply voltages. The EL5166 and EL5167 have an input range which extends to within 1.8V of either supply. So, for example, on ± 5 V supplies, the EL5166 and EL5167 have an input range

which spans $\pm 3.2V$. The output range of the EL5166 and EL5167 is also quite large, extending to within 1V of the supply rail. On a $\pm 5V$ supply, the output is therefore capable of swinging from $-4V$ to $+4V$.

Video Performance

For good video performance, an amplifier is required to maintain the same output impedance and the same frequency response as DC levels are changed at the output. This is especially difficult when driving a standard video load of 150Ω , because of the change in output current with DC level. Previously, good differential gain could only be achieved by running high idle currents through the output transistors (to reduce variations in output impedance.) These currents were typically comparable to the entire 8.5mA supply current of each EL5166 and EL5167 amplifier. Special circuitry has been incorporated in the EL5166 and EL5167 to reduce the variation of output impedance with current output. This results in dG and dP specifications of 0.01% and 0.03°, while driving 150Ω at a gain of 2.

Output Drive Capability

In spite of their low 8.5mA of supply current, the EL5166 and EL5167 are capable of providing a minimum of $\pm 110mA$ of output current. With so much output drive, the EL5166 and EL5167 are capable of driving 50Ω loads to both rails, making them an excellent choice for driving isolation transformers in telecommunications applications.

Driving Cables and Capacitive Loads

When used as a cable driver, double termination is always recommended for reflection-free performance. For those applications, the back-termination series resistor will decouple the EL5166 and EL5167 from the cable and allow extensive capacitive drive. However, other applications may have high capacitive loads without a back-termination resistor. In these applications, a small series resistor (usually between 5Ω and 50Ω) can be placed in series with the output to eliminate most peaking. The gain resistor (R_G) can then be chosen to make up for any gain loss which may be created by this additional resistor at the output. In many cases it is also possible to simply increase the value of the feedback resistor (R_F) to reduce the peaking.

Current Limiting

The EL5166 and EL5167 have no internal current-limiting circuitry. If the output is shorted, it is possible to exceed the Absolute Maximum Rating for output current or power dissipation, potentially resulting in the destruction of the device.

Power Dissipation

With the high output drive capability of the EL5166 and EL5167, it is possible to exceed the $125^\circ C$ Absolute Maximum junction temperature under certain very high load current conditions. Generally speaking when R_L falls below

about 25Ω , it is important to calculate the maximum junction temperature (T_{JMAX}) for the application to determine if power supply voltages, load conditions, or package type need to be modified for the EL5166 and EL5167 to remain in the safe operating area. These parameters are calculated as follows:

$$T_{JMAX} = T_{MAX} + (\theta_{JA} \times n \times PD_{MAX})$$

where:

T_{MAX} = Maximum ambient temperature

θ_{JA} = Thermal resistance of the package

n = Number of amplifiers in the package

PD_{MAX} = Maximum power dissipation of each amplifier in the package

PD_{MAX} for each amplifier can be calculated as follows:

$$PD_{MAX} = (2 \times V_S \times I_{SMAX}) + \left[(V_S - V_{OUTMAX}) \times \frac{V_{OUTMAX}}{R_L} \right]$$

where:

V_S = Supply voltage

I_{SMAX} = Maximum supply current of 1A

V_{OUTMAX} = Maximum output voltage (required)

R_L = Load resistance

Typical Application Circuits

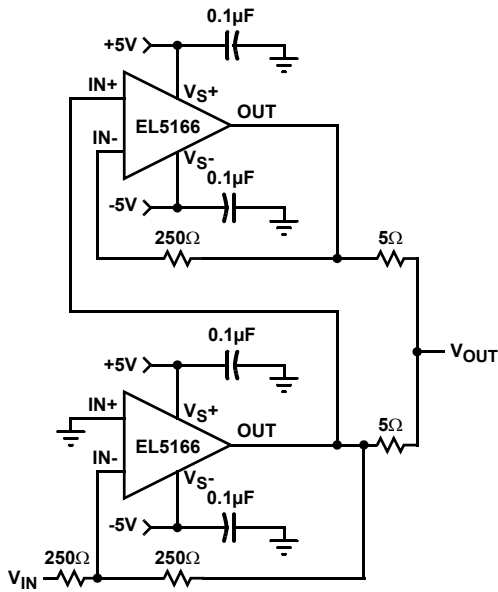

FIGURE 26. INVERTING 200mA OUTPUT CURRENT DISTRIBUTION AMPLIFIER

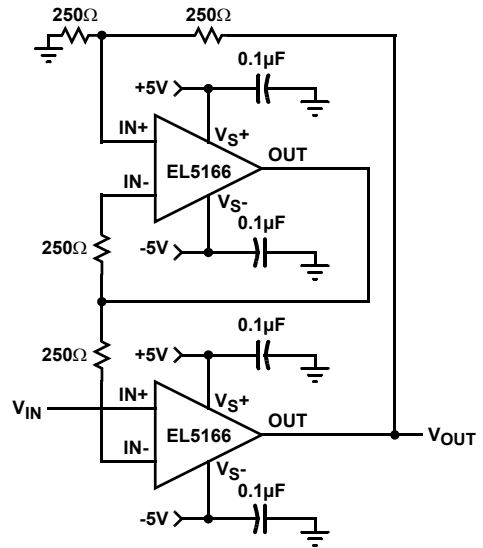

FIGURE 27. FAST-SETTLING PRECISION AMPLIFIER

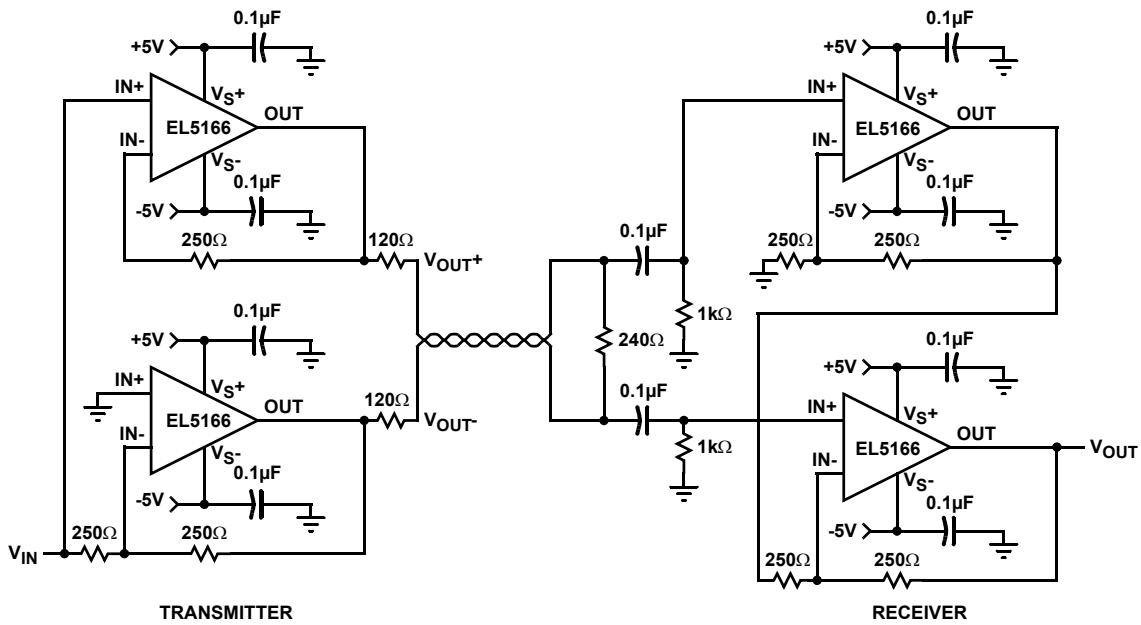
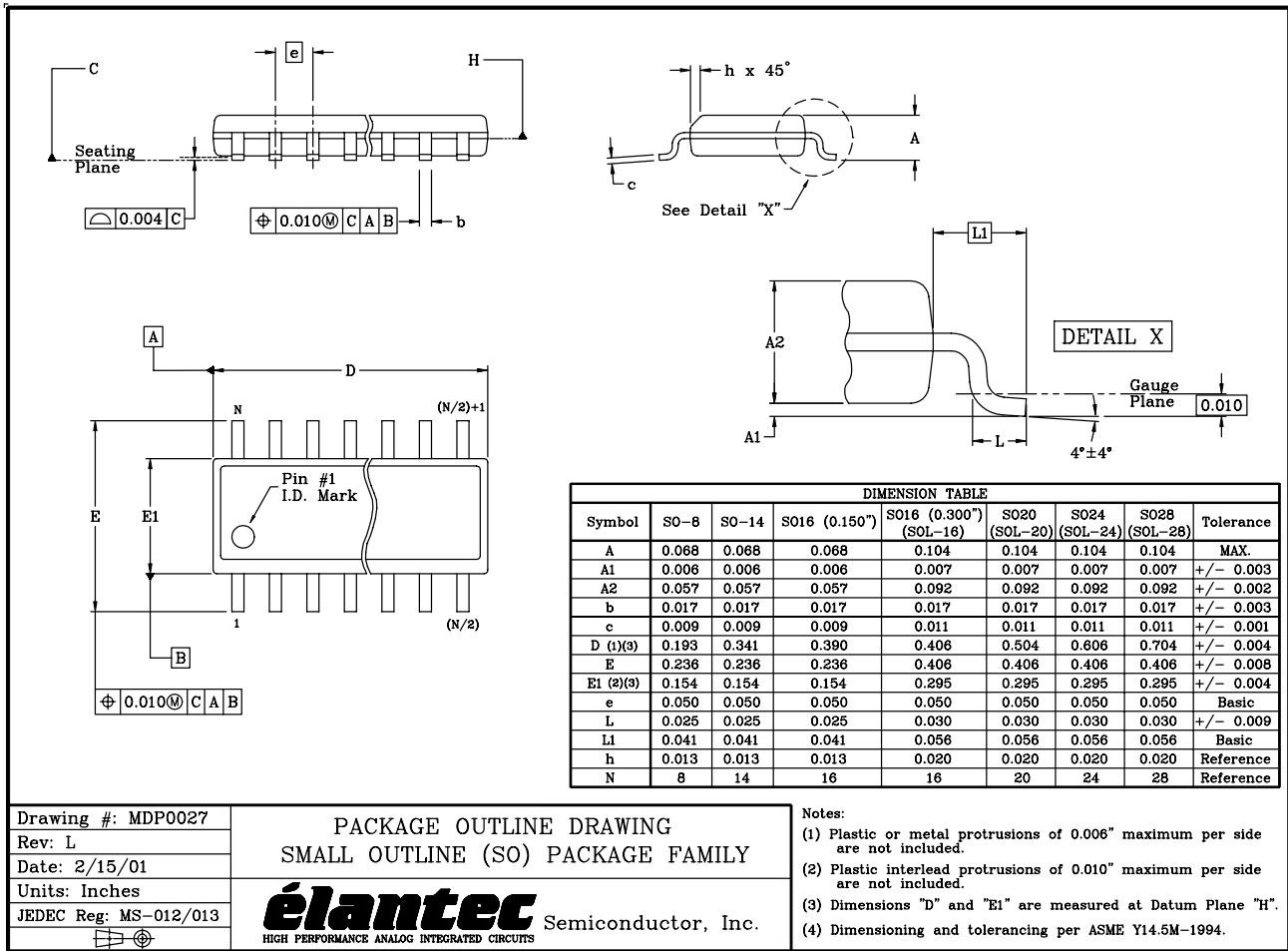

FIGURE 28. DIFFERENTIAL LINE DRIVER/RECEIVER

SO Package Outline Drawing



Drawing #: MDP0027
 Rev: L
 Date: 2/15/01
 Units: Inches
 JEDEC Reg: MS-012/013

PACKAGE OUTLINE DRAWING
 SMALL OUTLINE (SO) PACKAGE FAMILY

élantec Semiconductor, Inc.
 HIGH PERFORMANCE ANALOG INTEGRATED CIRCUITS

Notes:
 (1) Plastic or metal protrusions of 0.006" maximum per side are not included.
 (2) Plastic interlead protrusions of 0.010" maximum per side are not included.
 (3) Dimensions "D" and "E1" are measured at Datum Plane "H".
 (4) Dimensioning and tolerancing per ASME Y14.5M-1994.

SOT-23 Package Outline Drawing

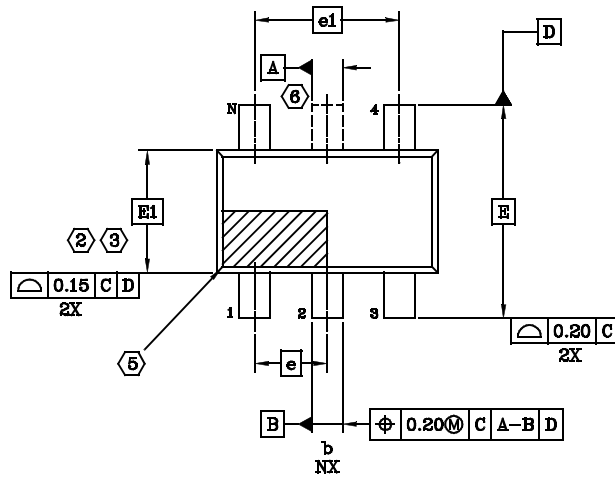

DIMENSION TABLE			
Symbol	SOT23-5	SOT23-6	Tolerance
A	1.45	1.45	MAX.
A1	0.10	0.10	+/- 0.05
A2	1.14	1.14	+/- 0.15
b	0.40	0.40	+/- 0.05
c	0.14	0.14	+/- 0.06
D	2.90	2.90	Basic
E	2.80	2.80	Basic
E1	1.60	1.60	Basic
e	0.95	0.95	Basic
e1	1.90	1.90	Basic
L	0.45	0.45	+/- 0.10
L1	0.80	0.80	Reference
N	5	6	Reference

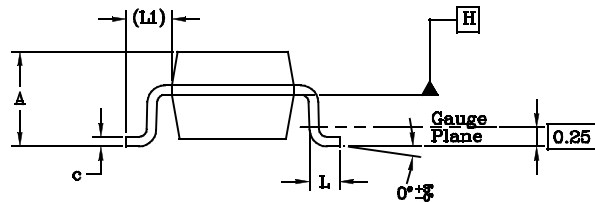
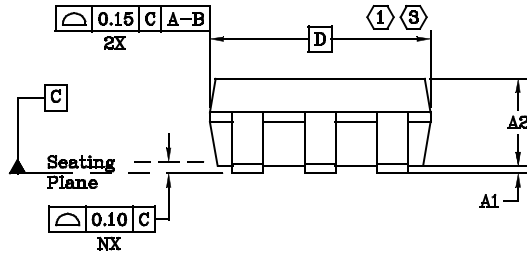

Notes:

- ① Plastic or metal protrusions of 0.25 mm maximum per side are not included.
- ② Plastic interlead protrusions of 0.25 mm maximum per side are not included.
- ③ This dimension is measured at Datum Plane "H".
- ④ Dimensioning and tolerancing per ASME Y14.5M-1994.
- ⑤ Index area - Pin #1 LD. will be located within the indicated zone (SOT23-6 only).
- ⑥ SOT23-5 version has no center lead (shown as a dashed line).

Drawing #: MDP0038
 Rev: E
 Date: 3/13/00
 Units: mm
 JEDEC Reg: MO-178

PACKAGE OUTLINE DRAWING
 SOT-23 PACKAGE FAMILY

elantec Semiconductor, Inc.
 HIGH PERFORMANCE ANALOG INTEGRATED CIRCUITS

SC-70 Package Outline Drawing

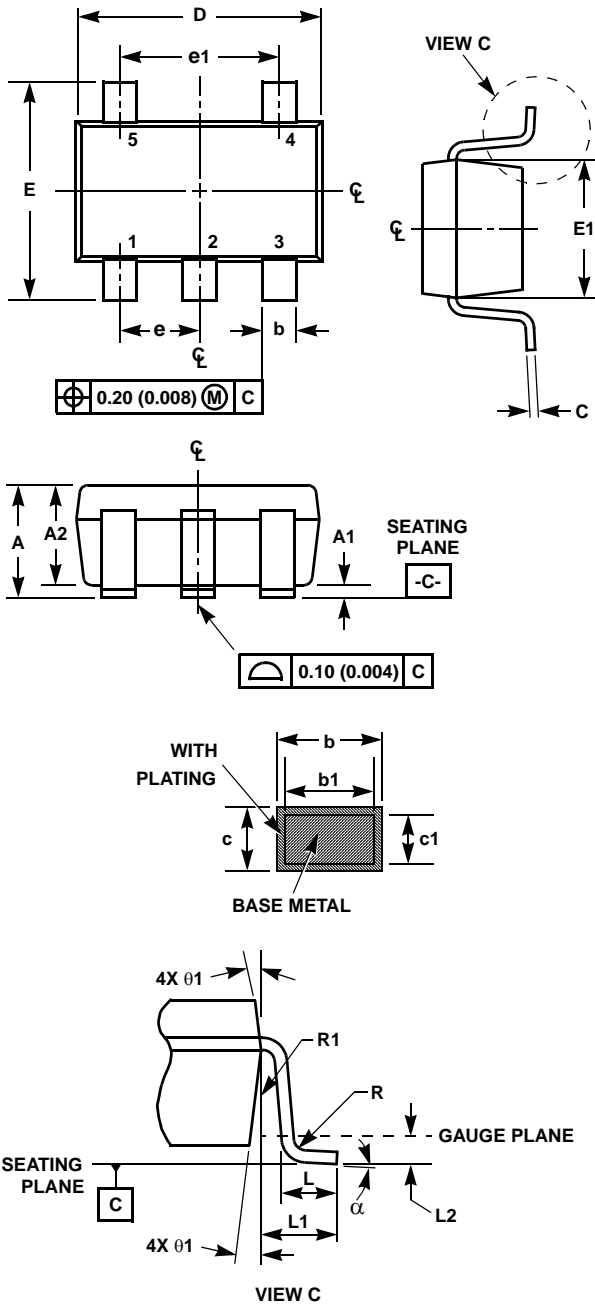

P5.049

5 LEAD SMALL OUTLINE TRANSISTOR PLASTIC PACKAGE

SYMBOL	INCHES		MILLIMETERS		NOTES
	MIN	MAX	MIN	MAX	
A	0.031	0.043	0.80	1.10	-
A1	0.000	0.004	0.00	0.10	-
A2	0.031	0.039	0.80	1.00	-
b	0.006	0.012	0.15	0.30	-
b1	0.006	0.010	0.15	0.25	
c	0.003	0.009	0.08	0.22	6
c1	0.003	0.009	0.08	0.20	6
D	0.073	0.085	1.85	2.15	3
E	0.071	0.094	1.80	2.40	-
E1	0.045	0.053	1.15	1.35	3
e	0.0256 Ref		0.65 Ref		-
e1	0.0512 Ref		1.30 Ref		-
L	0.010	0.018	0.26	0.46	4
L1	0.017 Ref.		0.420 Ref.		-
L2	0.006 BSC		0.15 BSC		
α	0°	8°	0°	8°	-
N	5		5		5
R	0.004	-	0.10	-	
R1	0.004	0.010	0.15	0.25	

Rev. 2 9/03

NOTES:

1. Dimensioning and tolerances per ASME Y14.5M-1994.
2. Package conforms to EIAJ SC70 and JEDEC MO-203AA.
3. Dimensions D and E1 are exclusive of mold flash, protrusions, or gate burrs.
4. Footlength L measured at reference to gauge plane.
5. "N" is the number of terminal positions.
6. These Dimensions apply to the flat section of the lead between 0.08mm and 0.15mm from the lead tip.
7. Controlling dimension: MILLIMETER. Converted inch dimensions are for reference only.

NOTE: The package drawing shown here may not be the latest version. To check the latest revision, please refer to the Intersil website at <<http://www.intersil.com/design/packages/index.asp>>

All Intersil U.S. products are manufactured, assembled and tested utilizing ISO9000 quality systems. Intersil Corporation's quality certifications can be viewed at www.intersil.com/design/quality

Intersil products are sold by description only. Intersil Corporation reserves the right to make changes in circuit design, software and/or specifications at any time without notice. Accordingly, the reader is cautioned to verify that data sheets are current before placing orders. Information furnished by Intersil is believed to be accurate and reliable. However, no responsibility is assumed by Intersil or its subsidiaries for its use; nor for any infringements of patents or other rights of third parties which may result from its use. No license is granted by implication or otherwise under any patent or patent rights of Intersil or its subsidiaries.

For information regarding Intersil Corporation and its products, see www.intersil.com