

BFG424W

NPN 25 GHz wideband transistor

Rev. 01 — 21 March 2006

Product data sheet

1. Product profile

1.1 General description

NPN double polysilicon wideband transistor with buried layer for low voltage applications in a plastic, 4-pin dual-emitter SOT343R package.

CAUTION



This device is sensitive to ElectroStatic Discharge (ESD). Therefore care should be taken during transport and handling.

1.2 Features

- Very high power gain
- Low noise figure
- High transition frequency
- Emitter is thermal lead
- Low feedback capacitance

1.3 Applications

- Radio Frequency (RF) front end wideband applications such as:
 - ◆ analog and digital cellular telephones
 - ◆ cordless telephones (Cordless Telephone (CT), Personal Handy-phone System (PHS), Digital Enhanced Cordless Telecommunications (DECT), etc.)
 - ◆ radar detectors
 - ◆ pagers
 - ◆ Satellite Antenna TeleVison (SATV) tuners
 - ◆ high frequency oscillators e.g. Dielectric Resonator Oscillator (DRO) for Low Noise Block (LNB)

1.4 Quick reference data

Table 1: Quick reference data

Symbol	Parameter	Conditions	Min	Typ	Max	Unit
V_{CBO}	collector-base voltage	open emitter	-	-	10	V
V_{CEO}	collector-emitter voltage	open base	-	-	4.5	V
I_C	collector current		-	25	30	mA
P_{tot}	total power dissipation	$T_{sp} \leq 103\text{ }^\circ\text{C}$	1]	-	135	mW

PHILIPS

Table 1: Quick reference data ...continued

Symbol	Parameter	Conditions	Min	Typ	Max	Unit
h_{FE}	DC current gain	$I_C = 25 \text{ mA}; V_{CE} = 2 \text{ V}; T_j = 25 \text{ }^\circ\text{C}$	50	80	120	
C_{CBS}	collector-base capacitance	$V_{CB} = 2 \text{ V}; f = 1 \text{ MHz}$	-	105	-	fF
f_T	transition frequency	$I_C = 25 \text{ mA}; V_{CE} = 2 \text{ V}; f = 2 \text{ GHz}; T_{amb} = 25 \text{ }^\circ\text{C}$	-	25	-	GHz
$G_{p(max)}$	maximum power gain	$I_C = 25 \text{ mA}; V_{CE} = 2 \text{ V}; f = 2 \text{ GHz}; T_{amb} = 25 \text{ }^\circ\text{C}$	[2]	-	22	dB
NF	noise figure	$I_C = 2 \text{ mA}; V_{CE} = 2 \text{ V}; f = 2 \text{ GHz}; \Gamma_S = \Gamma_{opt}$	-	1.2	-	dB

[1] T_{sp} is the temperature at the soldering point of the emitter pins.

[2] $G_{p(max)}$ is the maximum power gain, if $K > 1$. If $K < 1$ then $G_{p(max)}$ = Maximum Stable Gain (MSG), see [Figure 8](#).

2. Pinning information

Table 2: Pinning

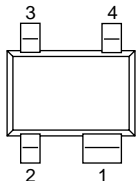
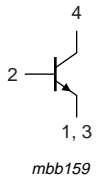
Pin	Description	Simplified outline	Symbol
1	emitter		
2	base		
3	emitter		
4	collector		

3. Ordering information

Table 3: Ordering information

Type number	Package		
	Name	Description	Version
BFG424W	-	plastic surface mounted package; reverse pinning; 4 leads	SOT343R

4. Marking

Table 4: Marking

Type number	Marking code [1]
BFG424W	ND*

[1] * = p: made in Hong Kong.

5. Limiting values

Table 5: Limiting values

In accordance with the Absolute Maximum Rating System (IEC 60134).

Symbol	Parameter	Conditions	Min	Max	Unit
V_{CBO}	collector-base voltage	open emitter	-	10	V
V_{CEO}	collector-emitter voltage	open base	-	4.5	V
V_{EBO}	emitter-base voltage	open collector	-	1	V
I_C	collector current		-	30	mA
P_{tot}	total power dissipation	$T_{sp} \leq 103\text{ }^\circ\text{C}$	[1]	135	mW
T_{stg}	storage temperature		-65	+150	$^\circ\text{C}$
T_j	junction temperature		-	150	$^\circ\text{C}$

[1] T_{sp} is the temperature at the soldering point of the emitter pins.

6. Thermal characteristics

Table 6: Thermal characteristics

Symbol	Parameter	Conditions	Typ	Unit
$R_{th(j-sp)}$	thermal resistance from junction to solder point	$T_{sp} \leq 103\text{ }^\circ\text{C}$	[1] 340	K/W

[1] T_{sp} is the temperature at the soldering point of the emitter pins.

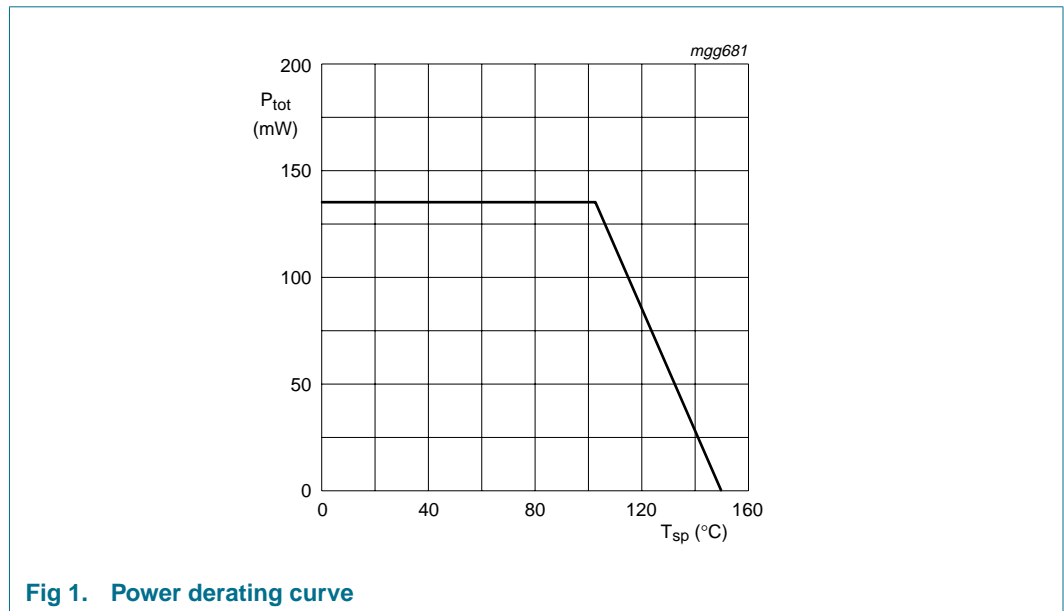

Fig 1. Power derating curve

7. Characteristics

Table 7: Characteristics

$T_j = 25\text{ °C}$; unless otherwise specified.

Symbol	Parameter	Conditions	Min	Typ	Max	Unit
$V_{(BR)CBO}$	collector-base breakdown voltage	$I_C = 2.5\ \mu\text{A}$; $I_E = 0\ \text{mA}$	10	-	-	V
$V_{(BR)CEO}$	collector-emitter breakdown voltage	$I_C = 1\ \text{mA}$; $I_B = 0\ \text{mA}$	4.5	-	-	V
$V_{(BR)EBO}$	open-collector emitter-base breakdown voltage	$I_E = 2.5\ \mu\text{A}$; $I_C = 0\ \text{mA}$	1	-	-	V
I_{CBO}	collector-base cut-off current	$I_E = 0\ \text{mA}$; $V_{CB} = 4.5\ \text{V}$	-	-	15	nA
h_{FE}	DC current gain	$I_C = 25\ \text{mA}$; $V_{CE} = 2\ \text{V}$	50	80	120	
C_{CES}	collector-emitter capacitance	$V_{CB} = 2\ \text{V}$; $f = 1\ \text{MHz}$	-	385	-	fF
C_{EBS}	emitter-base capacitance	$V_{EB} = 0.5\ \text{V}$; $f = 1\ \text{MHz}$	-	515	-	fF
C_{CBS}	collector-base capacitance	$V_{CB} = 2\ \text{V}$; $f = 1\ \text{MHz}$	-	105	-	fF
f_T	transition frequency	$I_C = 25\ \text{mA}$; $V_{CE} = 2\ \text{V}$; $f = 2\ \text{GHz}$; $T_{amb} = 25\text{ °C}$	-	25	-	GHz
$G_{p(max)}$	maximum power gain	$I_C = 25\ \text{mA}$; $V_{CE} = 2\ \text{V}$; $f = 2\ \text{GHz}$; $T_{amb} = 25\text{ °C}$	[1]	22	-	dB
$ S_{21} ^2$	insertion power gain	$I_C = 25\ \text{mA}$; $V_{CE} = 2\ \text{V}$; $f = 2\ \text{GHz}$; $T_{amb} = 25\text{ °C}$	-	18	-	dB
NF	noise figure	$I_C = 2\ \text{mA}$; $V_{CE} = 2\ \text{V}$; $f = 900\ \text{MHz}$; $\Gamma_S = \Gamma_{opt}$	-	0.8	-	dB
		$I_C = 2\ \text{mA}$; $V_{CE} = 2\ \text{V}$; $f = 2\ \text{GHz}$; $\Gamma_S = \Gamma_{opt}$	-	1.2	-	dB
$P_{L(1dB)}$	output power at 1 dB gain compression	$I_C = 25\ \text{mA}$; $V_{CE} = 2\ \text{V}$; $f = 2\ \text{GHz}$; $Z_S = Z_{S(opt)}$; $Z_L = Z_{L(opt)}$	[2]	12	-	dBm
IP3	third-order intercept point	$I_C = 25\ \text{mA}$; $V_{CE} = 2\ \text{V}$; $f = 2\ \text{GHz}$; $Z_S = Z_{S(opt)}$; $Z_L = Z_{L(opt)}$	[2]	22	-	dBm

[1] $G_{p(max)}$ is the maximum power gain, if $K > 1$. If $K < 1$ then $G_{p(max)} = \text{MSG}$, see [Figure 8](#).

[2] Z_S is optimized for noise; Z_L is optimized for gain.

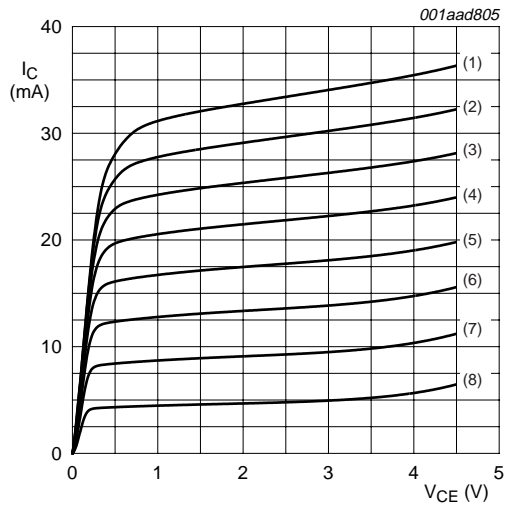

- (1) $I_B = 400 \mu A$
- (2) $I_B = 350 \mu A$
- (3) $I_B = 300 \mu A$
- (4) $I_B = 250 \mu A$
- (5) $I_B = 200 \mu A$
- (6) $I_B = 150 \mu A$
- (7) $I_B = 100 \mu A$
- (8) $I_B = 50 \mu A$

Fig 2. Collector current as a function of collector-emitter voltage; typical values

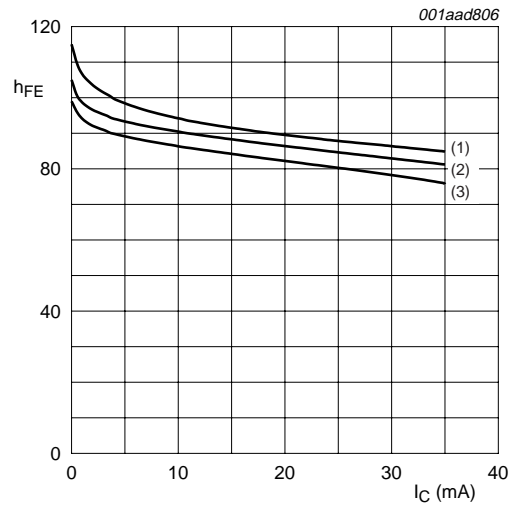

- (1) $V_{CE} = 3 V$
- (2) $V_{CE} = 2 V$
- (3) $V_{CE} = 1 V$

Fig 3. DC current gain as a function of collector current; typical values

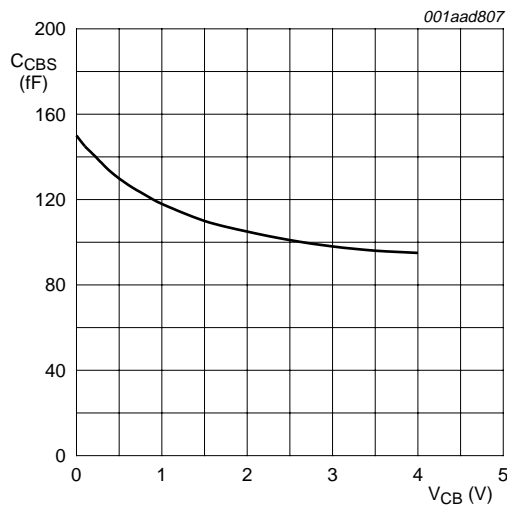

$f = 1 \text{ MHz}$

Fig 4. Collector-base capacitance as a function of collector-base voltage; typical values

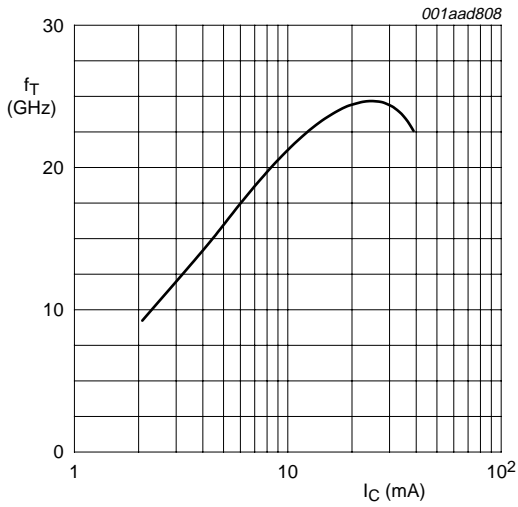

$V_{CE} = 2\text{ V}; f = 2\text{ GHz}; T_{amb} = 25\text{ }^{\circ}\text{C}$

Fig 5. Transition frequency as a function of collector current; typical values

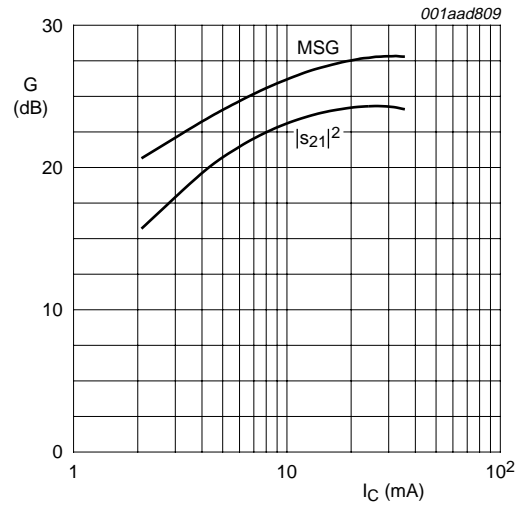

$V_{CE} = 2\text{ V}; f = 0.9\text{ GHz}; T_{amb} = 25\text{ }^{\circ}\text{C}$

Fig 6. Gain as a function of collector current; typical values

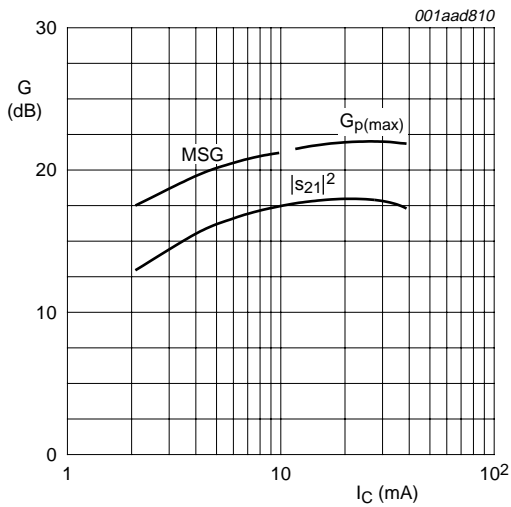

$V_{CE} = 2\text{ V}; f = 2\text{ GHz}; T_{amb} = 25\text{ }^{\circ}\text{C}$

Fig 7. Gain as a function of collector current; typical values

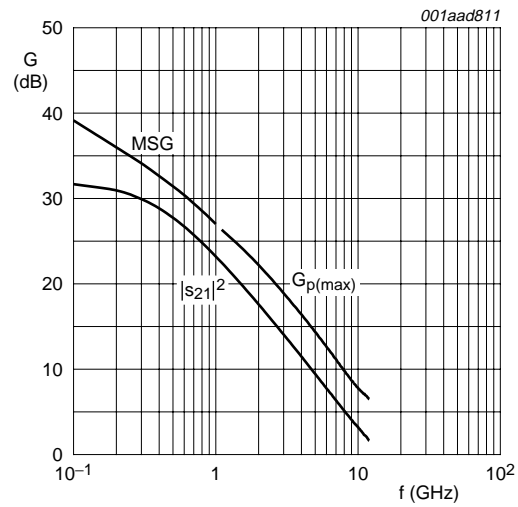

$V_{CE} = 2\text{ V}; I_C = 25\text{ mA}; T_{amb} = 25\text{ }^{\circ}\text{C}$

Fig 8. Gain as a function of frequency; typical values

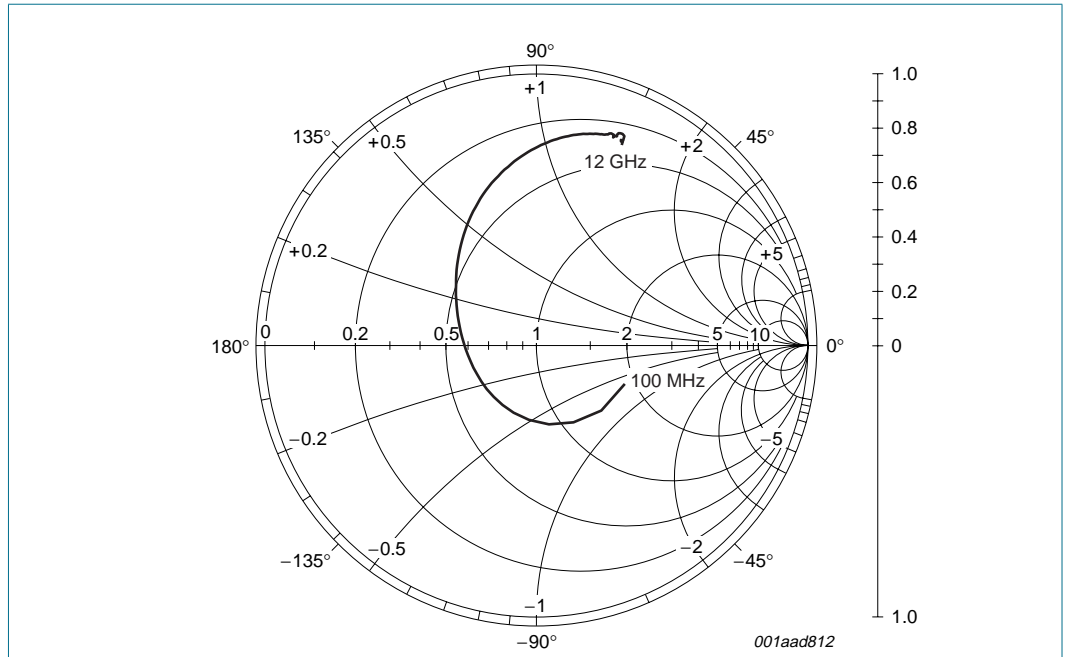

$V_{CE} = 2\text{ V}; I_C = 25\text{ mA}; Z_o = 50\ \Omega$

Fig 9. Common emitter input reflection coefficient (s_{11}); typical values

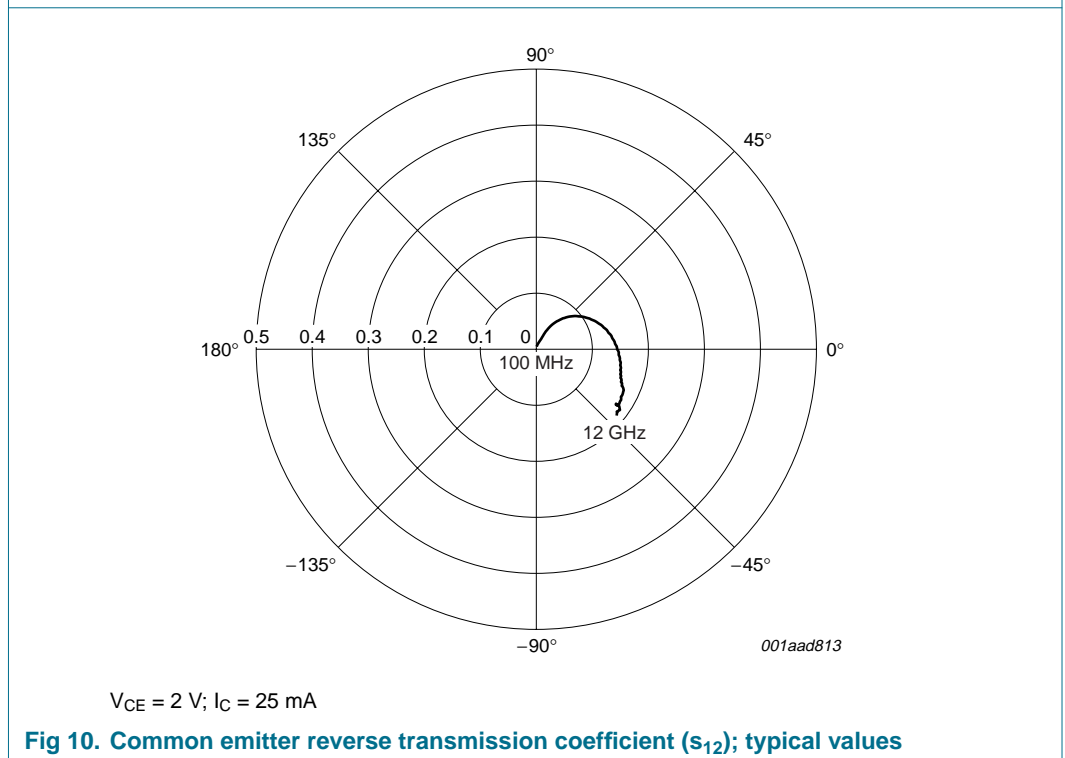

$V_{CE} = 2\text{ V}; I_C = 25\text{ mA}$

Fig 10. Common emitter reverse transmission coefficient (s_{12}); typical values

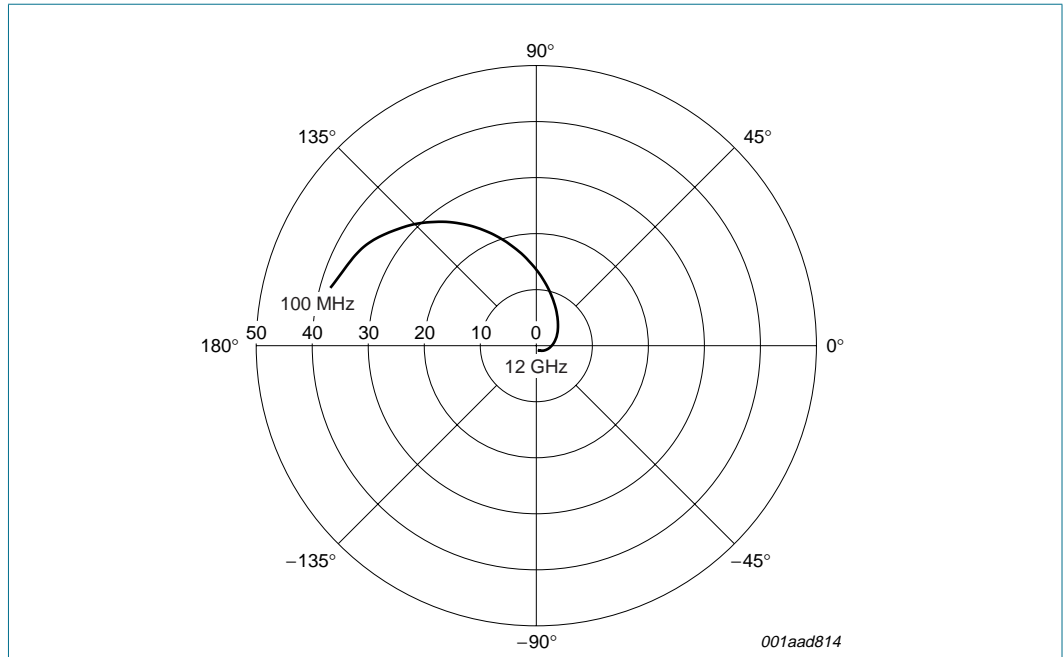

$V_{CE} = 2\text{ V}; I_C = 25\text{ mA}$

Fig 11. Common emitter forward transmission coefficient (s_{21}); typical values

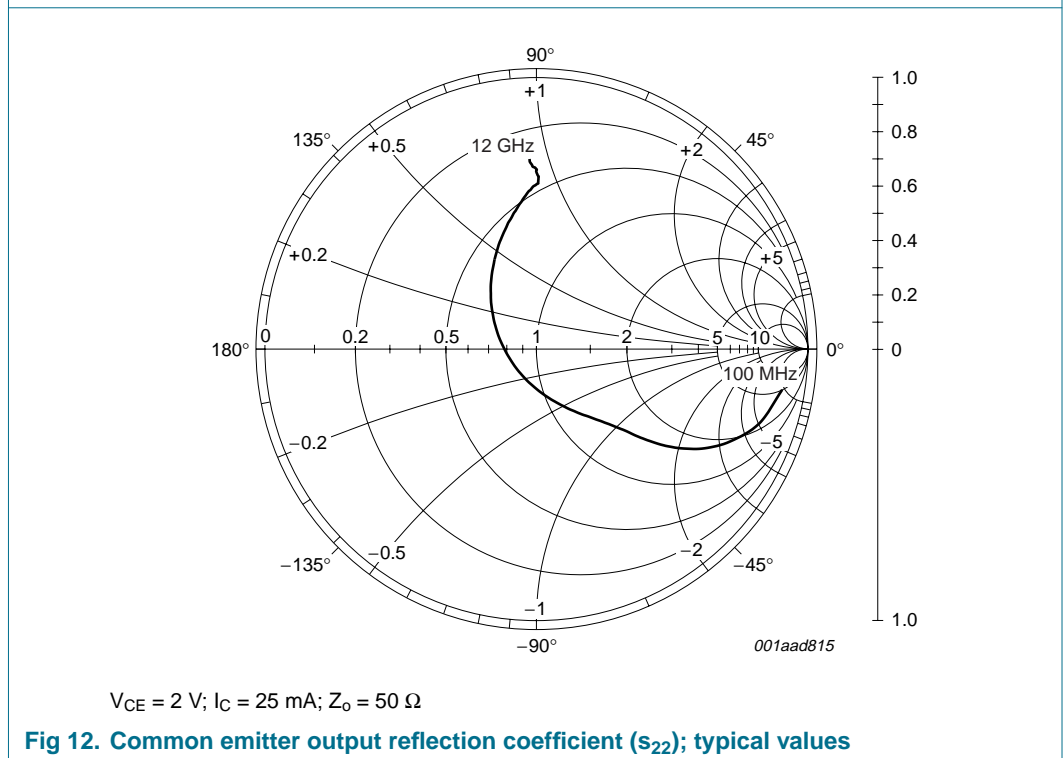

$V_{CE} = 2\text{ V}; I_C = 25\text{ mA}; Z_o = 50\ \Omega$

Fig 12. Common emitter output reflection coefficient (s_{22}); typical values

7.1 Noise data

Table 8: Noise data

$V_{CE} = 2\text{ V}$; typical values.

f (MHz)	I _C (mA)	NF _{min} (dB)	Γ _{opt}		r _n (Ω)
			ratio	(deg)	
900	1	0.7	0.67	19.1	0.40
	2	0.81	0.48	17.8	0.27
	4	1	0.28	11.7	0.24
	10	1.4	0.02	-63.9	0.19
	15	1.65	0.11	-162.4	0.18
	20	1.9	0.19	-165.5	0.18
	25	2.1	0.25	-166.3	0.19
	30	2.3	0.29	-166.5	0.19
2000	1	1.3	0.56	57.5	0.36
	2	1.2	0.43	57.2	0.25
	4	1.2	0.22	60.8	0.18
	10	1.6	0.06	137.4	0.19
	15	1.9	0.13	-162.1	0.20
	20	2.2	0.17	-155.5	0.20
	25	2.5	0.22	-152.2	0.21
	30	2.8	0.27	-150.8	0.25

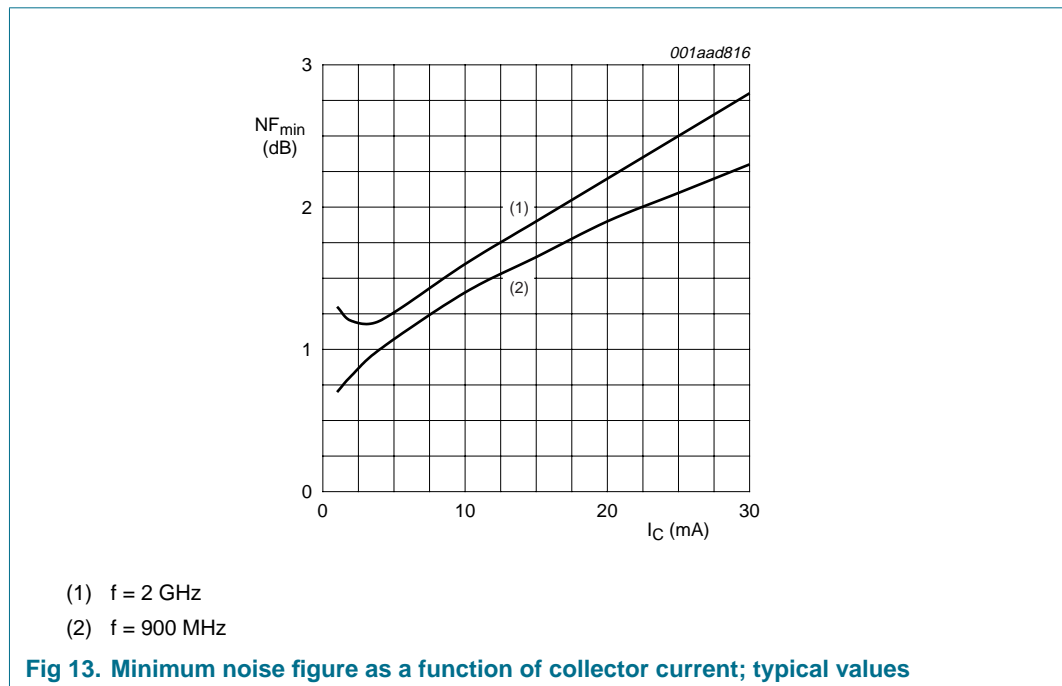

8. Package outline

Plastic surface-mounted package; reverse pinning; 4 leads

SOT343R

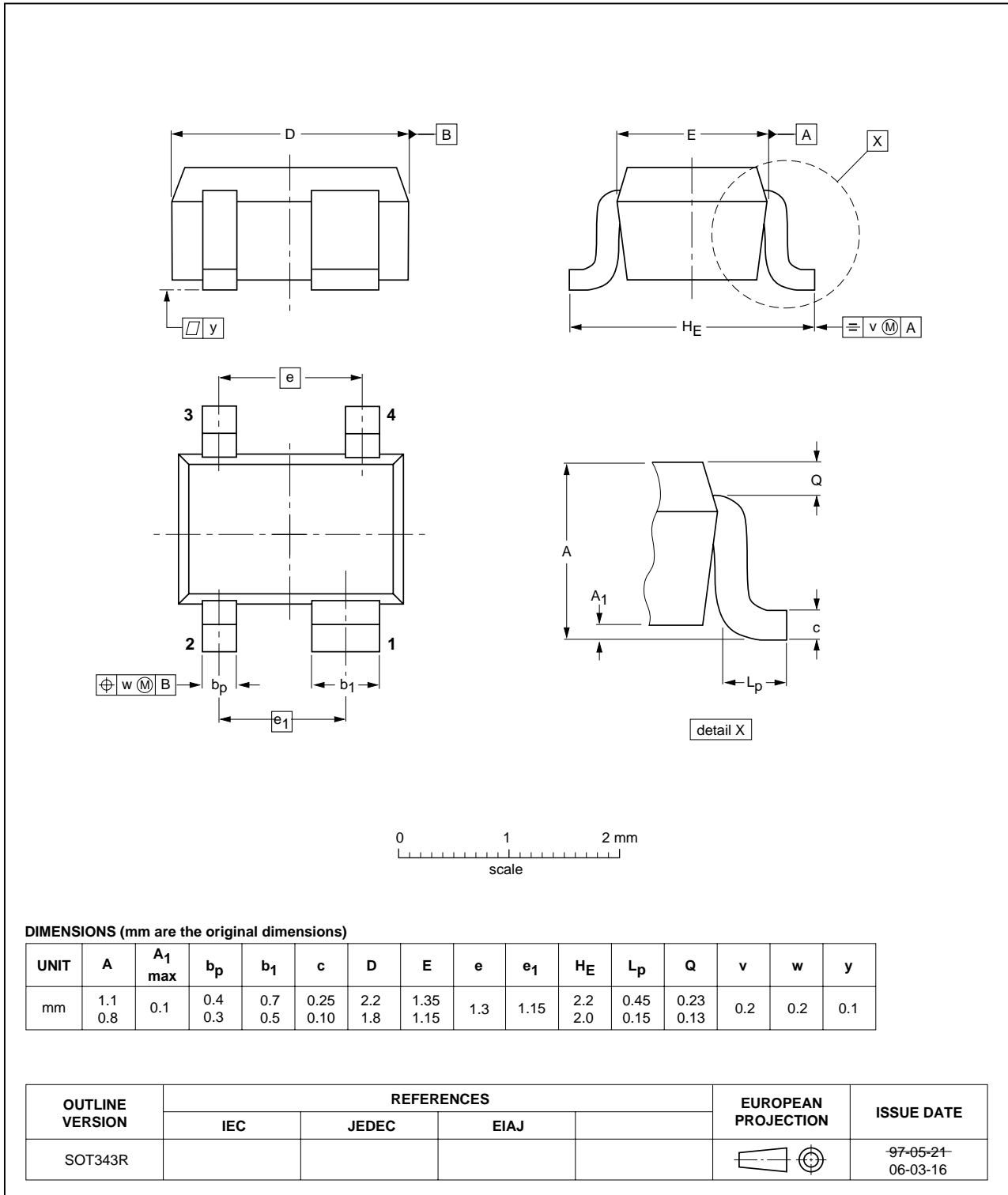

Fig 14. Package outline SOT343R

9. Revision history

Table 9: Revision history

Document ID	Release date	Data sheet status	Change notice	Supersedes
BFG424W_1	20060321	Product data sheet	-	-

10. Data sheet status

Level	Data sheet status ^[1]	Product status ^[2] ^[3]	Definition
I	Objective data	Development	This data sheet contains data from the objective specification for product development. Philips Semiconductors reserves the right to change the specification in any manner without notice.
II	Preliminary data	Qualification	This data sheet contains data from the preliminary specification. Supplementary data will be published at a later date. Philips Semiconductors reserves the right to change the specification without notice, in order to improve the design and supply the best possible product.
III	Product data	Production	This data sheet contains data from the product specification. Philips Semiconductors reserves the right to make changes at any time in order to improve the design, manufacturing and supply. Relevant changes will be communicated via a Customer Product/Process Change Notification (CPCN).

[1] Please consult the most recently issued data sheet before initiating or completing a design.

[2] The product status of the device(s) described in this data sheet may have changed since this data sheet was published. The latest information is available on the Internet at URL <http://www.semiconductors.philips.com>.

[3] For data sheets describing multiple type numbers, the highest-level product status determines the data sheet status.

11. Definitions

Short-form specification — The data in a short-form specification is extracted from a full data sheet with the same type number and title. For detailed information see the relevant data sheet or data handbook.

Limiting values definition — Limiting values given are in accordance with the Absolute Maximum Rating System (IEC 60134). Stress above one or more of the limiting values may cause permanent damage to the device. These are stress ratings only and operation of the device at these or at any other conditions above those given in the Characteristics sections of the specification is not implied. Exposure to limiting values for extended periods may affect device reliability.

Application information — Applications that are described herein for any of these products are for illustrative purposes only. Philips Semiconductors makes no representation or warranty that such applications will be suitable for the specified use without further testing or modification.

12. Disclaimers

Life support — These products are not designed for use in life support appliances, devices, or systems where malfunction of these products can reasonably be expected to result in personal injury. Philips Semiconductors

14. Contact information

For additional information, please visit: <http://www.semiconductors.philips.com>

For sales office addresses, send an email to: sales.addresses@www.semiconductors.philips.com

customers using or selling these products for use in such applications do so at their own risk and agree to fully indemnify Philips Semiconductors for any damages resulting from such application.

Right to make changes — Philips Semiconductors reserves the right to make changes in the products - including circuits, standard cells, and/or software - described or contained herein in order to improve design and/or performance. When the product is in full production (status 'Production'), relevant changes will be communicated via a Customer Product/Process Change Notification (CPCN). Philips Semiconductors assumes no responsibility or liability for the use of any of these products, conveys no license or title under any patent, copyright, or mask work right to these products, and makes no representations or warranties that these products are free from patent, copyright, or mask work right infringement, unless otherwise specified.

13. Trademarks

Notice — All referenced brands, product names, service names and trademarks are the property of their respective owners.

15. Contents

1	Product profile	1
1.1	General description	1
1.2	Features	1
1.3	Applications	1
1.4	Quick reference data	1
2	Pinning information	2
3	Ordering information	2
4	Marking	2
5	Limiting values	3
6	Thermal characteristics	3
7	Characteristics	4
7.1	Noise data	9
8	Package outline	10
9	Revision history	11
10	Data sheet status	12
11	Definitions	12
12	Disclaimers	12
13	Trademarks	12
14	Contact information	12



© Koninklijke Philips Electronics N.V. 2006

All rights are reserved. Reproduction in whole or in part is prohibited without the prior written consent of the copyright owner. The information presented in this document does not form part of any quotation or contract, is believed to be accurate and reliable and may be changed without notice. No liability will be accepted by the publisher for any consequence of its use. Publication thereof does not convey nor imply any license under patent- or other industrial or intellectual property rights.

Date of release: 21 March 2006
BFG424W_1

Published in The Netherlands