

Diode Full Bridge Power Module

$V_{RRM} = 1000V$
 $I_C = 100A @ T_c = 70^\circ C$

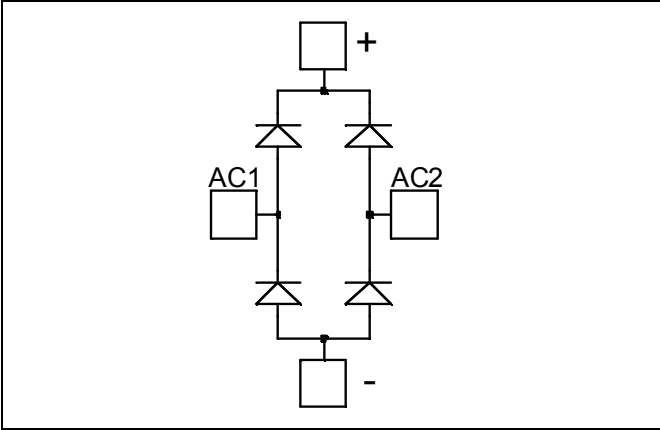

Application

- Uninterruptible Power Supply (UPS)
- Induction heating
- Welding equipment
- High speed rectifiers

Features

- Ultra fast recovery times
- Soft recovery characteristics
- High blocking voltage
- High current
- Low leakage current
- Very low stray inductance
 - Symmetrical design
 - Lead frames for power connections
- High level of integration

Benefits

- Outstanding performance at high frequency operation
- Low losses
- Low noise switching
- Solderable terminals for easy PCB mounting
- Direct mounting to heatsink (isolated package)
- Low junction to case thermal resistance
- RoHS Compliant

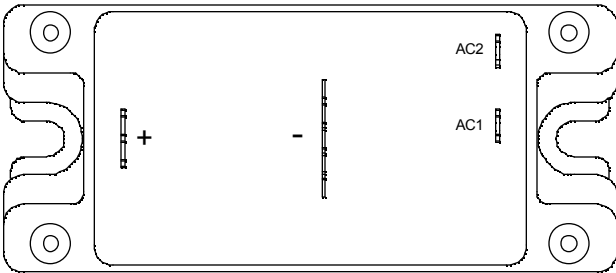

Absolute maximum ratings

Symbol	Parameter	Max ratings	Unit		
V_R	Maximum DC reverse Voltage	1000	V		
V_{RRM}	Maximum Peak Repetitive Reverse Voltage				
$I_{F(AV)}$	Maximum Average Forward Current	Duty cycle = 50%	$T_C = 25^\circ C$	130	A
			$T_C = 70^\circ C$	100	
$I_{F(RMS)}$	RMS Forward Current	Duty cycle = 50%	$T_C = 45^\circ C$	130	
I_{FSM}	Non-Repetitive Forward Surge Current	8.3ms	$T_C = 45^\circ C$	500	

CAUTION: These Devices are sensitive to Electrostatic Discharge. Proper Handling Procedures Should Be Followed. See application note APT0502 on www.microsemi.com

All ratings @ $T_j = 25^\circ\text{C}$ unless otherwise specified

Electrical Characteristics

<i>Symbol</i>	<i>Characteristic</i>	<i>Test Conditions</i>		<i>Min</i>	<i>Typ</i>	<i>Max</i>	<i>Unit</i>
V_F	Diode Forward Voltage	$I_F = 100\text{A}$			2.1	2.7	V
		$I_F = 150\text{A}$			2.3		
		$I_F = 100\text{A}$	$T_j = 125^\circ\text{C}$		1.7		
I_{RM}	Maximum Reverse Leakage Current	$V_R = 1000\text{V}$	$T_j = 25^\circ\text{C}$			100	μA
			$T_j = 125^\circ\text{C}$			500	
C_T	Junction Capacitance	$V_R = 1000\text{V}$			120		pF

Dynamic Characteristics

<i>Symbol</i>	<i>Characteristic</i>	<i>Test Conditions</i>		<i>Min</i>	<i>Typ</i>	<i>Max</i>	<i>Unit</i>
t_{rr}	Reverse Recovery Time	$I_F = 1\text{A}, V_R = 30\text{V}$ $di/dt = 100\text{A}/\mu\text{s}$	$T_j = 25^\circ\text{C}$		45		ns
t_{rr}	Reverse Recovery Time	$I_F = 100\text{A}$ $V_R = 667\text{V}$ $di/dt = 200\text{A}/\mu\text{s}$	$T_j = 25^\circ\text{C}$		290		ns
			$T_j = 125^\circ\text{C}$		340		
Q_{rr}	Reverse Recovery Charge		$T_j = 25^\circ\text{C}$		685		nC
			$T_j = 125^\circ\text{C}$		3645		
I_{RRM}	Reverse Recovery Current		$T_j = 25^\circ\text{C}$		6		A
			$T_j = 125^\circ\text{C}$		18		
t_{rr}	Reverse Recovery Time	$I_F = 100\text{A}$ $V_R = 667\text{V}$ $di/dt = 1000\text{A}/\mu\text{s}$	$T_j = 125^\circ\text{C}$		160		ns
Q_{rr}	Reverse Recovery Charge				7100		nC
I_{RRM}	Reverse Recovery Current				70		A

Thermal and package characteristics

<i>Symbol</i>	<i>Characteristic</i>	<i>Min</i>	<i>Typ</i>	<i>Max</i>	<i>Unit</i>	
R_{thJC}	Junction to Case Thermal Resistance			0.55	$^\circ\text{C}/\text{W}$	
V_{ISOL}	RMS Isolation Voltage, any terminal to case $t = 1\text{ min}$, $I_{isol} < 1\text{mA}$, 50/60Hz	2500			V	
T_j	Operating junction temperature range	-40		175	$^\circ\text{C}$	
T_{STG}	Storage Temperature Range	-40		125		
T_C	Operating Case Temperature	-40		100		
Torque	Mounting torque	To Heatsink	M5	2.5	4.7	N.m
Wt	Package Weight				160	g

Typical Performance Curve

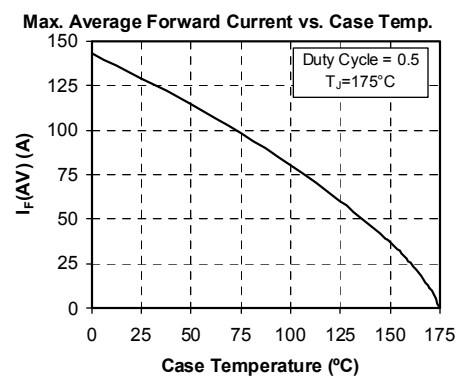
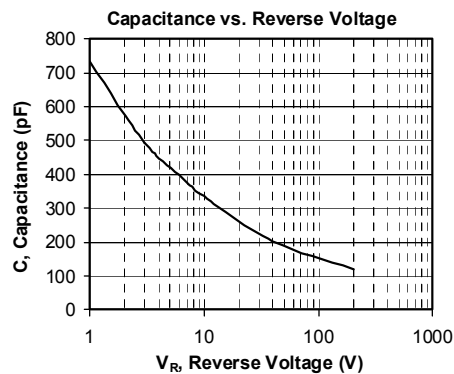
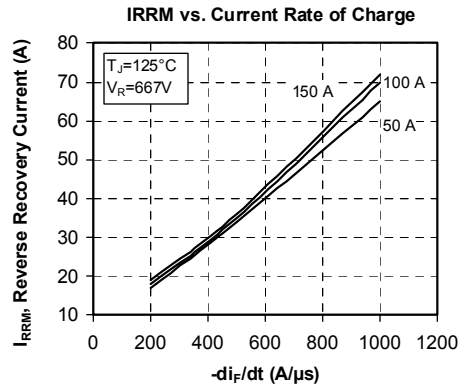
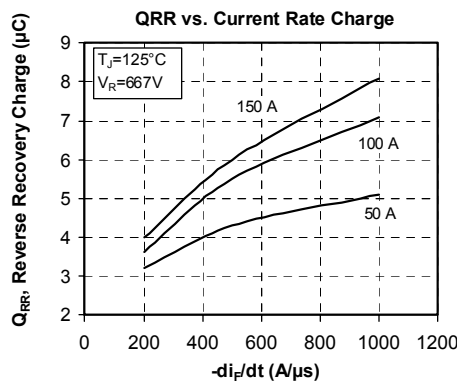
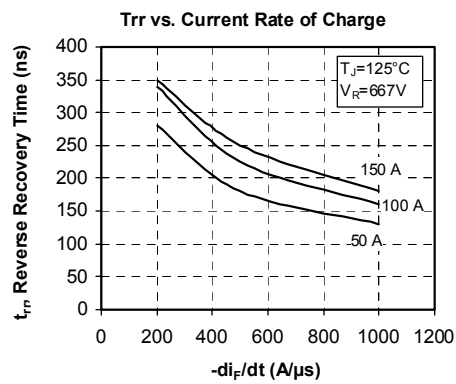
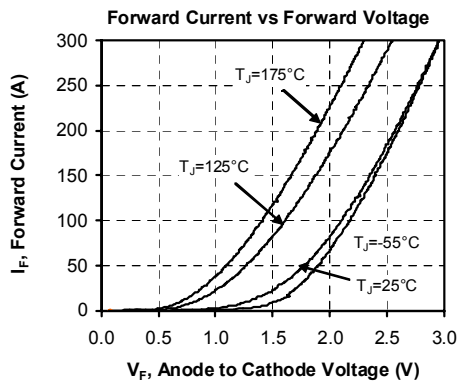
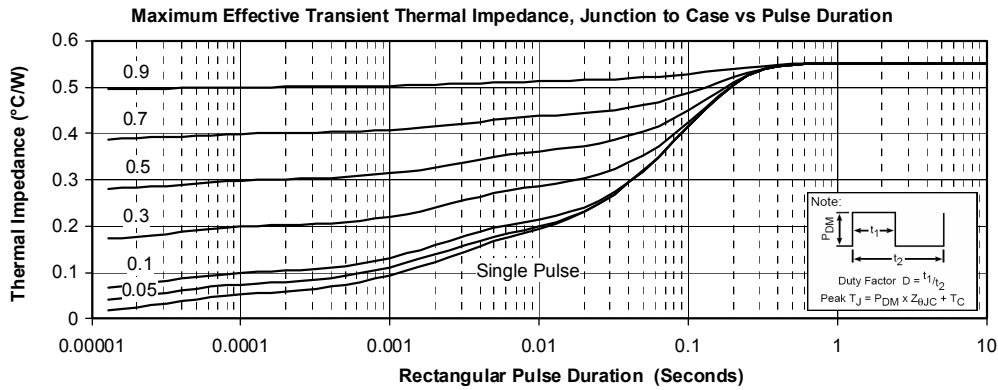

SP4 Package outline (dimensions in mm)

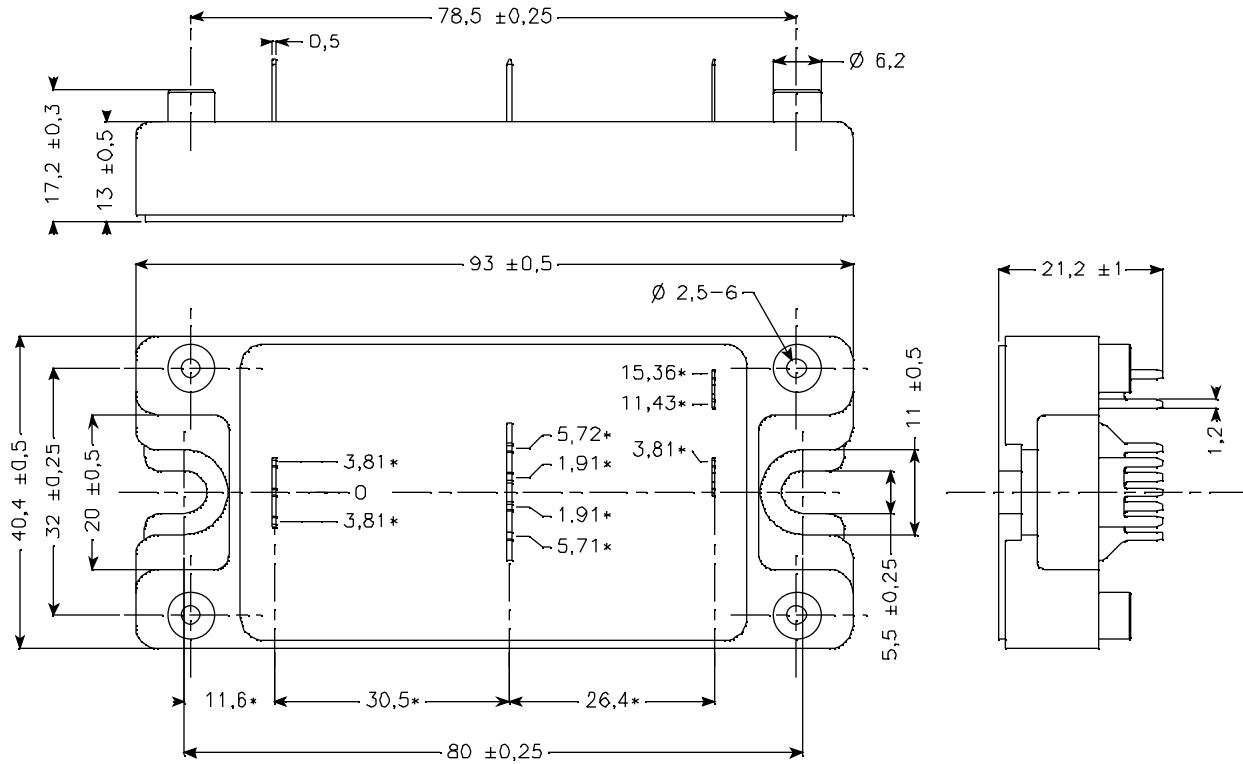

ALL DIMENSIONS MARKED "*" ARE TOLERENCED AS : $\phi \begin{matrix} \phi \\ \phi 1 \end{matrix}$

Microsemi reserves the right to change, without notice, the specifications and information contained herein

Microsemi's products are covered by one or more of U.S. patents 4,895,810 5,045,903 5,089,434 5,182,234 5,019,522 5,262,336 6,503,786 5,256,583 4,748,103 5,283,202 5,231,474 5,434,095 5,528,058 and foreign patents. U.S. and Foreign patents pending. All Rights Reserved.