

PRELIMINARY SPEC

Part Number: APKF3030SEEVGABE-F01



ATTENTION
OBSERVE PRECAUTIONS
FOR HANDLING
ELECTROSTATIC
DISCHARGE
SENSITIVE
DEVICES

HYPER ORANGE
GREEN
BLUE

Features

- LOW POWER CONSUMPTION.
- 3.0mmx3.0mm SMT LED, 2.0mm(MAX.) THICKNESS.
- ONE ORANGE, ONE GREEN AND ONE BLUE CHIPS IN ONE PACKAGE.
- CAN PRODUCE ANY COLOR IN VISIBLE SPECTRUM, INCLUDING WHITE LIGHT.
- PACKAGE : 1000PCS / REEL.
- MOISTURE SENSITIVITY LEVEL : LEVEL 4.
- RoHS COMPLIANT.

Description

The Hyper Orange source color devices are made with DH InGaAlP on GaAs substrate Light Emitting Diode.

The Green source color devices are made with InGaN on G-SiC Light Emitting Diode.

The Blue source color devices are made with InGaN on SiC Light Emitting Diode.

Static electricity and surge damage the LEDs.

It is recommended to use a wrist band or anti-electrostatic glove when handling the LEDs.

All devices, equipment and machinery must be electrically grounded.

Package Dimensions

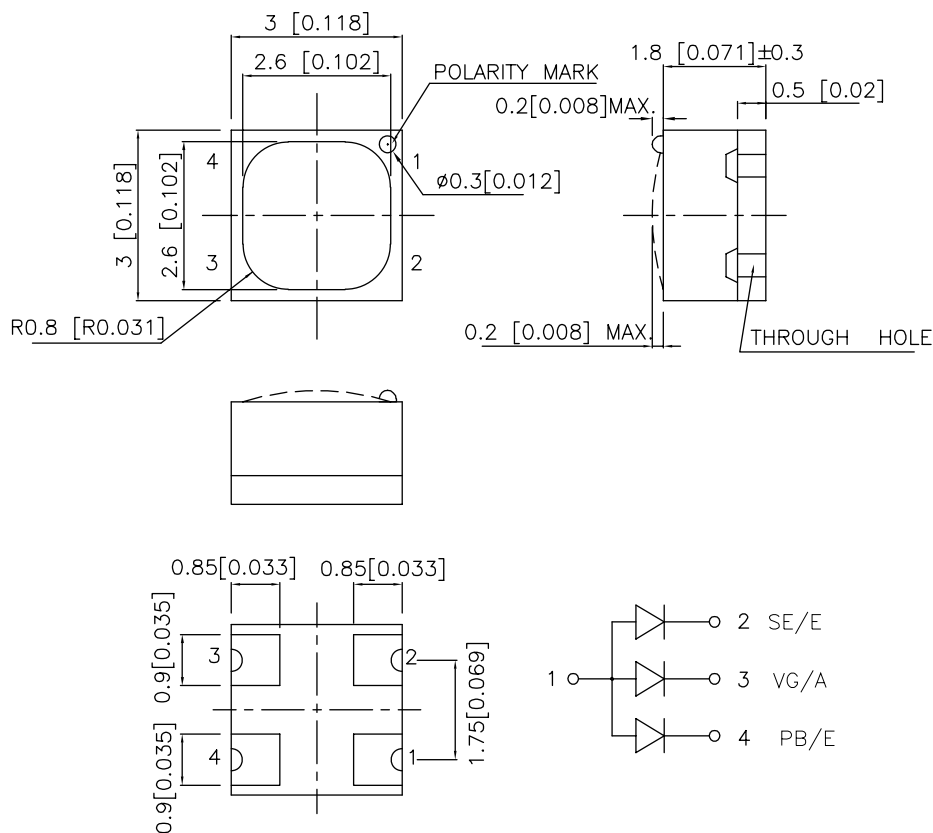

Notes:

1. All dimensions are in millimeters (inches).
2. Tolerance is ±0.2(0.008") unless otherwise noted.
3. Specifications are subject to change without notice.

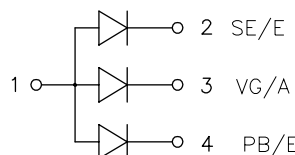

Selection Guide

Part No.	Dice	Lens Type	Iv (mcd) [2] @ 20mA		Viewing Angle [1]
			Min.	Typ.	2θ1/2
APKF3030SEEVGABE-F01	HYPER ORANGE(InGaAlP)	WATER CLEAR	180	400	100°
	GREEN (InGaN)		110	250	
	BLUE (InGaN)		50	120	

Notes:

1. θ1/2 is the angle from optical centerline where the luminous intensity is 1/2 the optical centerline value.
2. Luminous Intensity/ Luminous Flux: +/-15%.

Electrical / Optical Characteristics at TA=25°C

Symbol	Parameter	Device	Typ.	Max.	Units	Test Conditions
λ_{peak}	Peak Wavelength	Hyper Orange Green Blue	630 520 465		nm	I _F =20mA
λ_D [1]	Dominant Wavelength	Hyper Orange Green Blue	621 525 470		nm	I _F =20mA
$\Delta\lambda_{1/2}$	Spectral Line Half-width	Hyper Orange Green Blue	20 35 25		nm	I _F =20mA
C	Capacitance	Hyper Orange Green Blue	25 100 110		pF	V _F =0V;f=1MHz
V _F [2]	Forward Voltage	Hyper Orange Green Blue	2.0 3.2 3.7	2.5 4.0 4.3	V	I _F =20mA
I _R	Reverse Current	Hyper Orange Green Blue		10 10 10	uA	V _R = 5V

Notes:

1. Wavelength: +/-1nm.
2. Forward Voltage: +/-0.1V.

Absolute Maximum Ratings at TA=25°C

Parameter	Hyper Orange	Green	Blue	Units
Power dissipation	75	120	129	mW
DC Forward Current	30	30	30	mA
Peak Forward Current [1]	195	100	160	mA
Reverse Voltage	5			V
Operating/Storage Temperature	-40°C To +85°C			

Note:

1. 1/10 Duty Cycle, 0.1ms Pulse Width.

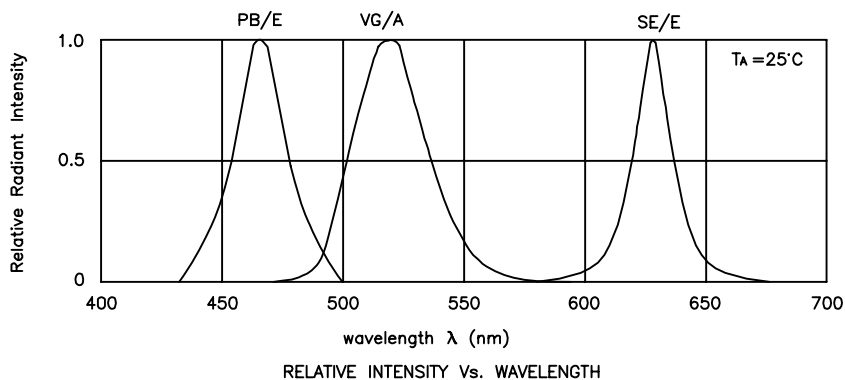

APKF3030SEEVGABE-F01 Hyper Orange

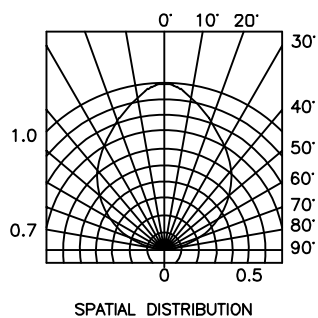
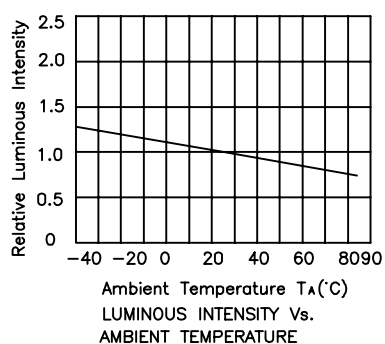
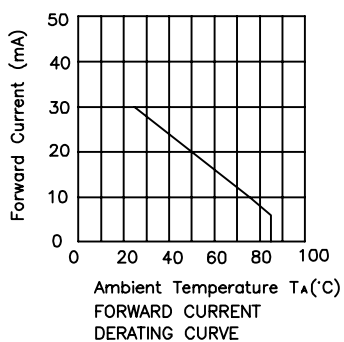
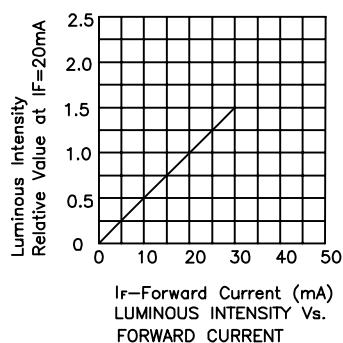
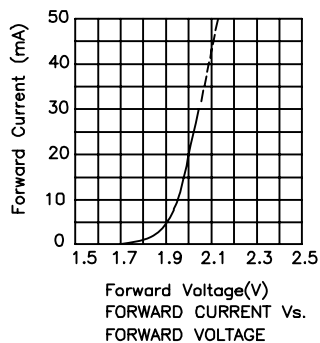

Green

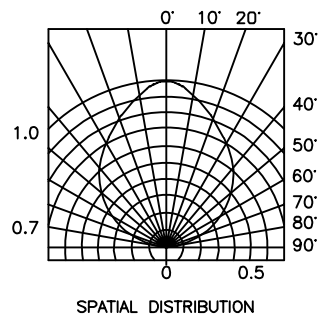
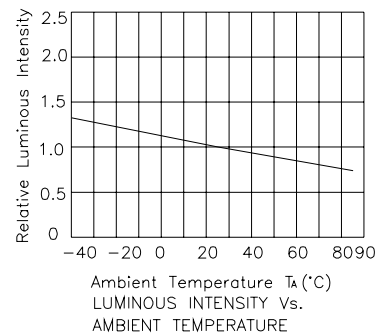
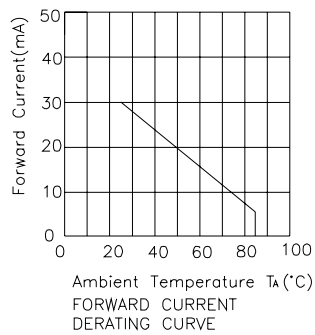
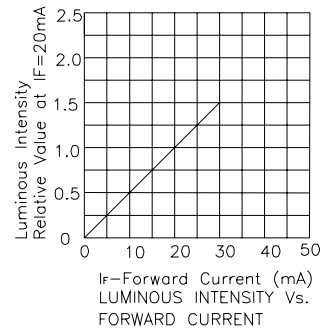
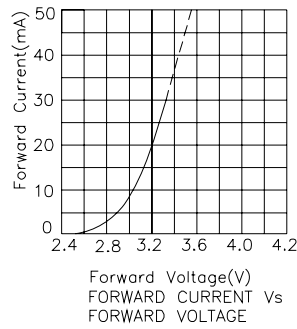

Blue

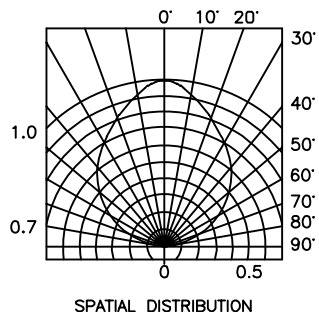
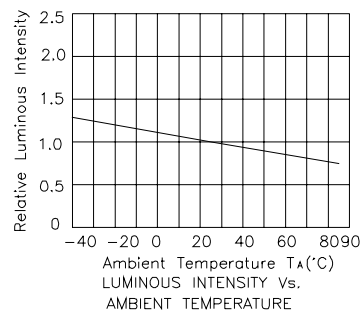
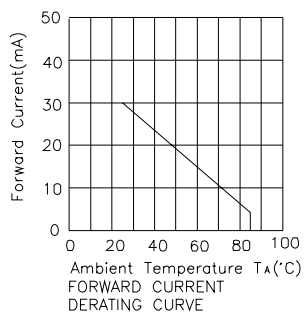
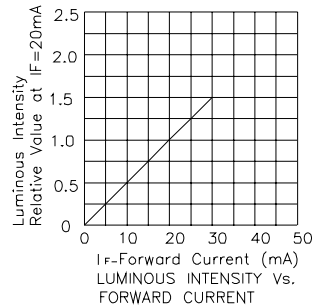
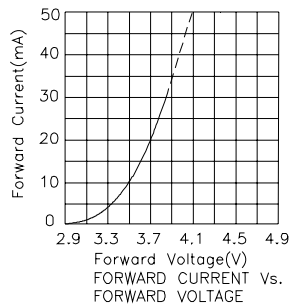

APKF3030SEEVGABE-F01

Reflow Soldering Profile For Lead-free SMT Process.

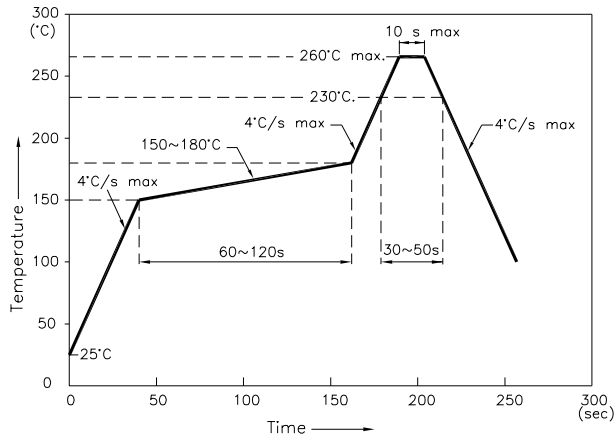

NOTES:

1. We recommend the reflow temperature 245°C(+/-5°C). The maximum soldering temperature should be limited to 260°C.
2. Don't cause stress to the epoxy resin while it is exposed to high temperature.
3. Number of reflow process shall be 2 times or less.

Recommended Soldering Pattern (Units : mm; Tolerance: ± 0.1)

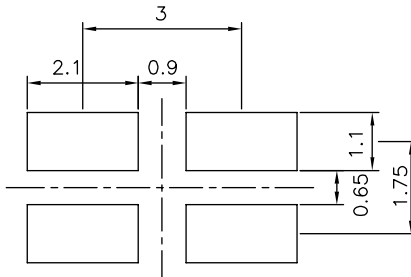

Tape Specifications (Units : mm)

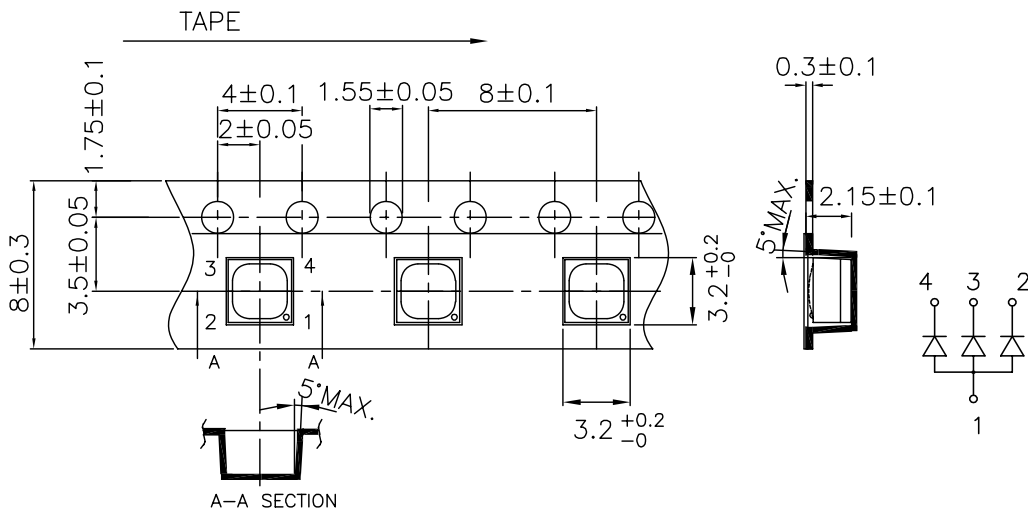

PACKING & LABEL SPECIFICATIONS

APKF3030SEEVGABE-F01

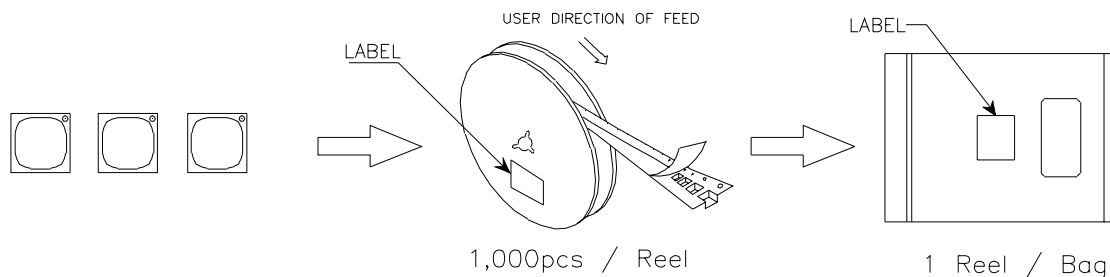

1,000pcs / Reel

1 Reel / Bag



30K / 20# BOX

OUTSIDE LABEL

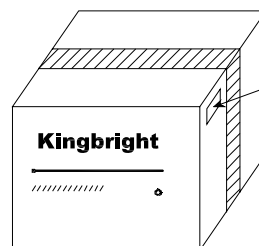

OUTSIDE LABEL

15K / 55# Box

Kingbright	
P/NO: APKF3030xxx	Q C xx xx. xxxx PASSED
QTY: 1,000 pcs	Q.C.
S/N: XXXX	
CODE: XXX	
LOT NO:	
	
xxxxxxxxxxxxxxxxxxxxxxxx	
RoHS Compliant	