



AKD4626

Evaluation board Rev.B for AK4626

GENERAL DESCRIPTION

The AKD4626 is an evaluation board for the AK4626, a single chip CODEC that includes two channels of ADC and six channels of DAC. The AKD4626 also has the digital audio interface and can achieve the interface with digital audio systems via opt-connector or BNC connector.

■ **Ordering guide**

- AKD4626 --- Evaluation board for AK4626
(Cable for connecting with printer port of IBM-AT compatible PC and control software are packed with this.) This control software can't operate on Windows NT.

FUNCTION

- On-board analog input buffer circuit
- Compatible with 2 types of interface
 - DIT(AK4103)/DIR(AK4112B) with optical output/input and BNC input
 - Direct interface with AC3 decoder by 10pin header
- 10pin header for serial control interface

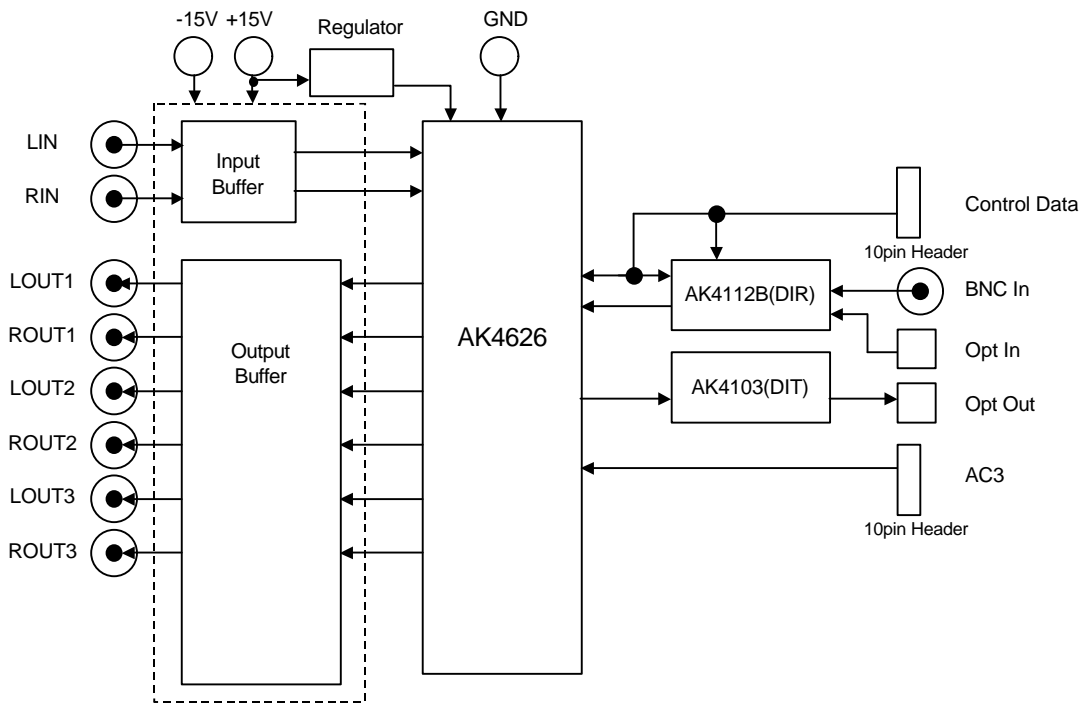

Fig 1. AKD4626 Block Diagram

*Circuit diagram and PCB layout are attached at the end of this manual.

■ Operation sequence

(1) Set up the power supply lines.

[+12V]	(orange jack)	= +12 ~ +15V
[-12V]	(blue jack)	= -12 ~ -15V
[AGND]	(black jack)	= 0V
[DGND]	(black jack)	= 0V

Each supply line should be distributed from the power supply unit.

±12V are supplied to analog interface.

+12V is regulated to +5V and +3.3V by regulators(T1,T2).

+5V is supplied to digital interface, AK4626 and TVDD of AK4112B.

+3.3V is supplied to AVDD and DVDD of AK4112B and TVDD of AK4626.

(2) Set up the evaluation mode and jumper pins. (See p.6.)

(3) Power on.

The AK4626, AK4112B and AK4103 should be reset once bringing PDN(SW1) "L" upon power-up.

(4) Set up software.

The control mode of AK4626 and AK4112B is fixed to "serial".

The AKD4626 can be controlled via the printer port (parallel port) of IBM-AT compatible PC. Connect PORT1(uP-I/F) with PC by 10-line flat cable packed with the AKD4626.

Take care of the direction of connector. There is a mark at pin#1.

The pin layout of PORT1 is as Figure 2.

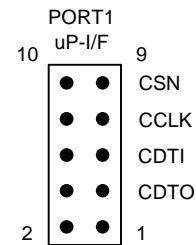

Figure 2. PORT1 pin layout

■ **Evaluation mode**

1) Evaluation of ADC

TOTX176 is used for digital output. Clock mode of the AK4112B should be set to PLL mode or X'tal mode.

2) Evaluation of DAC

TORX176 or BNC is used for digital input. Clock mode of the AK4112B should be set to PLL mode. "4112A" should be selected on JP4,5 and 7.

3) Loopback mode

Clock mode of the AK4112B should be set to PLL mode or X'tal mode. "4112A" should be selected on JP4,5 and 7.

4) Evaluation of DAC using DSP

"DSP" should be selected on JP4,5 and 7.

Evaluation mode	AK4112B clock set-up	JP4,5,7	Used I/F
ADC	CM1='0', CM0='0'(PLL mode) or CM1='0', CM0='1'(X'tal mode)	Don't care	TOTX176 optical output
DAC	CM1='0', CM0='0'(PLL mode)	"4112A"	
Loopback	CM1='0', CM0='1'(X'tal mode)	"4112A"	
Using DSP	CM1='0', CM0='0'(PLL mode)	"DSP"	PORT5(10-pin Header)

(Note.)1. Software "4112.exe" packed with the AKD4626 is used for set-up of the AK4112B.

2. CM1 and CM0 bits are D5 and D4 of Addr=00H, respectively

Table 2.Evaluation mode

■ **DIP Switch set up. (See the datasheet of AK4626 and AK4103)**

1.DFS_4529(SW2-1) set up of AK4626 Sampling speed(fs).

DFS_4529	Sampling Speed (fs)		Default
OFF	Normal Speed Mode	32kHz~48kHz	
ON	Double Speed Mode	64kHz~96kHz	

Table 3. Set up of Sampling Speed (fs)

2.V(SW2-2) set up of for AK4103Validity detect.

V	Validity	Default
OFF	Valid	
ON	Invalid	

Table 4. Set up of Validity

3.FS3(SW2-3) FS2(SW2-4) set up of AK4103 sampling frequency setting.

FS3	FS2	Sampling frequency setting	Default
OFF	OFF	44.1kHz	
OFF	ON	48kHz	
ON	OFF	Reserved	
ON	ON	32kHz	

Table 5. Set up of sampling frequency setting

4.CKS0(SW2-5) set up of AK4103 System Clock .

CKS1	MCLK	fs	Default
OFF	256fs	28k-108kHz	
ON	512fs	28k-54kz	

Table 6.Set up of System Clock

5.DIF0(SW2-6) set up of AK4103 Audio Serial Interface Format.

DIF0	Audio Serial Interface Format	LRCK	BICK	
OFF	24bit, Left justified	H/L	48fs-128fs	Default
ON	24bit, I ² S	L/H	48fs-128fs	

Table 7. Set up of Audio Serial Interface Format

■ Jumper pin set up

- [JP1] (GND) ---Analog GND and Digital GND
- [JP4,5,7]
(SDTI1,2,3) --- AK4626 SDTI1,2,3 input source select
<DSP> : Serial Data is input from DSP via PORT4.
<4112A> : Serial Data is input from AK4112B SDTO. <default>
- [JP3] (V/TX) --- AK4112B V/TX output select.
<V> : Validity. <default>
<TX> : Transmit channel (through data)
- [JP2](OPT/COAX) --- The source of the biphasic signal input to the AK4112B
<OPT_IN> : Optical input to RX1 of AK4112B <default>
<RX2> : BNC input to RX1 of AK4112B

■ The function of the toggle SW.

[SW1] : Resets the AK4626, AK4112B and AK4103. Keep “H” during normal operation.

■ The indication content for LED.

- [LE1] (DZF1) : Zero detection
[LE2] (DZF2_OVF) : Zero detection or Overflow Detection
[LE3] (ERF) : AK4112B unlock and parity error output.
[LE4] (FS96) : AK4112B 96kHz sampling detect.
[LE5] (AUTO) : AK4112B AC-3/MPEG detect.
[LE6] (V) : AK4112B Validity detect

■ Analog input circuit

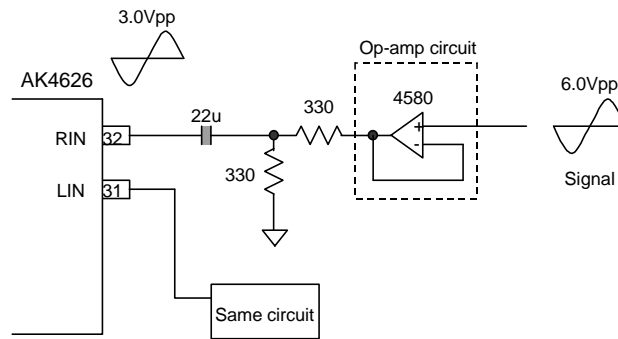

1) Gain

Gain of analog input circuit is

$$330/(330+330) = -6.02\text{dB.}$$

Therefore input level for this board is

$$+0.51\text{dBV}(=3.0\text{Vpp})+6.02\text{dB} \\ = +6.53\text{dBV} = 6.00\text{Vpp} = 2.12\text{Vrms.}$$

■ Analog output circuit

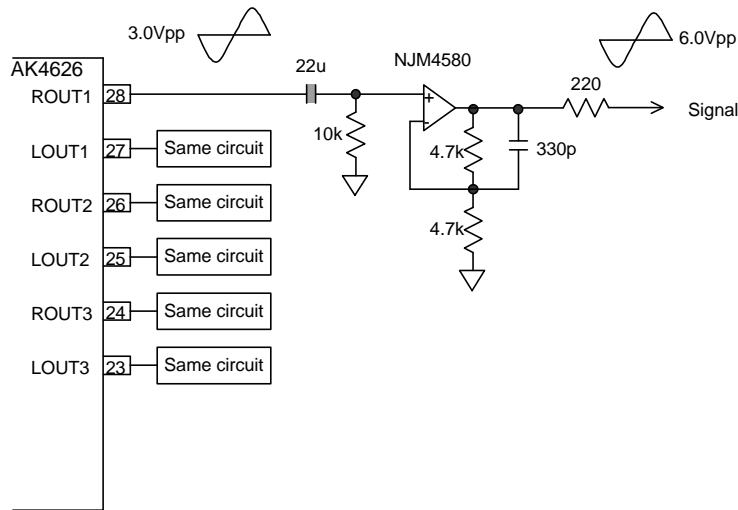

1st order LPF on this board

1) Frequency response of HPF

The HPF is implemented on board to cancel the DC offset of analog output of AK4626.

Frequency response of 1st-order HPF

$$| \text{Amplitude} |^2 = 1 / \{ 1 + (fc/f)^2 \}; fc = 1 / 2\pi RC = \mathbf{0.7Hz} @ R=10k, C=22u$$

fin	20Hz
Frequency Response	-0.006dB

2) Gain, S/N and frequency response of op-amp circuit

1st-order filter with non-inverting amp is implemented on board to double the analog output level and attenuate out-of-band noise.

a) Gain

The gain is

$$1 + 4.7k / 4.7k = +6.02dB.$$

Therefore the output level of this board is

$$0.51dBV (=3.0Vpp) + 6.02dB \\ = \mathbf{6.53dBV = 6.00Vpp = 2.12Vrms.}$$

c) Frequency response of filter

Frequency response of the 1st-order filter

$$| \text{Amplitude} |^2 = K * \{ 1 + (f/f_{c2})^2 \} / \{ 1 + (f/f_{c1})^2 \};$$

$$K = 1 + 4.7k / 4.7k = 2,$$

$$f_{c1} = 1 / 2\pi RC = 102.7kHz @ R=4.7k, C=330p,$$

$$f_{c2} = K * f_{c1} = 205.3kHz$$

Frequency response referenced to output level of this board is as following table:

fin	DC	20kHz	40kHz	80kHz	145kHz	∞
Frequency Response	0dB	-0.121dB	-0.452dB	-1.448dB	-3dB	-6dB

If the frequency response of filter influences the system, 1st-order LPF is also available as the following figure:

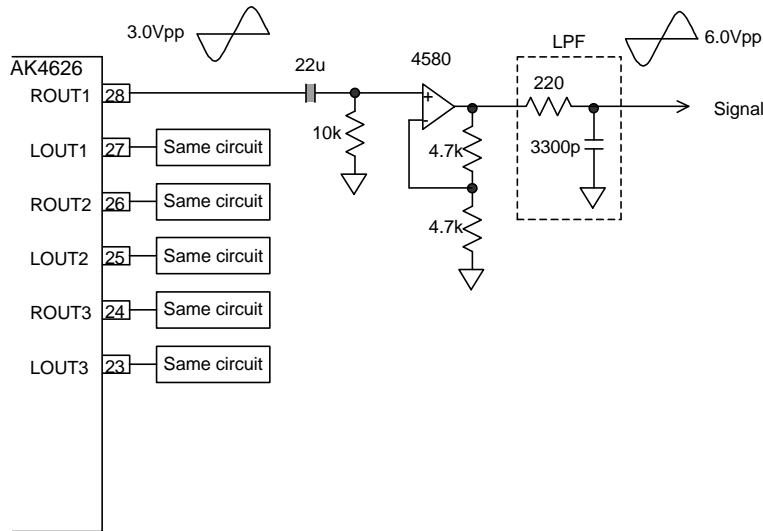

Example of LPF with flat response.

Frequency response of this LPF

$$| \text{Amplitude} |^2 = 1 / \{ 1 + (f/f_c)^2 \};$$

$$f_c = 1 / 2\pi RC = 219kHz @ R=220, C=3300p$$

Frequency response referenced to output level of this board is as following table:

fin	DC	20kHz	40kHz	80kHz	219kHz	∞
Frequency Response	0dB	-0.036dB	-0.142dB	-0.543dB	-3dB	-∞dB

The total frequency response of this board is sum of the external filter and internal LPF of AK4626.

These filters are effective to attenuate the high frequency noise since some measurement units is sensitive for out-of-band noise.

AK4626 Control Program operation manual

■ Set-up of evaluation board and control software

This evaluation board does not support I²C control.

1. Set up the AKD4626 according to above mentioned setting.
2. Connect IBM-AT compatible PC with AKD4626 by 10-line type flat cable (packed with AKD4626). Take care of the direction of 10pin header. (Please install the driver in the CD-ROM-disk when this control software is used on Windows 2000/XP. Please refer “Installation Manual of Control Software Driver by AKM device control software”. In case of Windows95/98/ME, this installation is not needed. This control software does not operate on Windows NT.)
3. Insert the CD-ROM-disk labeled “AK4626 Evaluation Kit” into the CD-ROM-disk drive.
4. Access the CD-ROM-disk drive and double-click the icon of “akd4626.exe” to set up the control program.
5. Then please evaluate according to the followings.

Attention: Please use fixed “CAD1-0=01”.

■ Explanation of each buttons

1. [Write default] : Initialize the register of AK4626.
2. [Function1] : Dialog to write data by keyboard operation.
3. [Function2] : Dialog to evaluate IPGA and ATTL/ATTR/ATTM.
4. [Write] : Write data to each register.
5. [Close]: Control Program is closed.

■ Explanation of each dialog

1. [Function1 Dialog] : Dialog to write data by keyboard operation

Address Box: Input register address in 2 figures of hexadecimal.
Data Box: Input register data in 2 figures of hexadecimal.

When [Write] button is clicked, the input data is written to AK4626.
When [Close] button is clicked, the Dialog box is closed.

2. [Function2 Dialog] : Dialog to evaluate IPGA and ATTL/ATTR/ATTM

This dialog supports to only addr=02H~07H.

Address Box: Input register address in 2 figures of hexadecimal.
Start Data Box: Input start data in 2 figures of hexadecimal.
End Data Box: Input end data in 2 figures of hexadecimal.
Interval Box: Data is written to AK4626 by this interval.
Step Box: Data changes by this step.
Mode Select Box:

If you check this check box, data reaches end data, and returns to start data.

[Example] Start Data = 00, End Data = 09
Data flow: 00 01 02 03 04 05 06 07 08 09 09 08 07 06 05 04 03 02 01 00

If you do not check this check box, data reaches end data, but does not return to start data.

[Example] Start Data = 00, End Data = 09
Data flow: 00 01 02 03 04 05 06 07 08 09

If you want to write the input data to AK4626, click "OK" button. If not, click "Cancel" button.

3. [Write Dialog] : Dialog to write data by mouse operation

There are dialogs corresponding to each register.

Click the "Write" button corresponding to each register to set up the dialog. If you check the check box, data becomes "H" or "1". If not, "L" or "0".

If you want to write the input data to AK4626, click "OK" button. If not, click "Cancel" button.

■ Indication of data

Input data is indicated on the register map. Red letter indicates "H" or "1" and blue one indicates "L" or "0". Blank is the part that is not defined in the datasheet.

■ Attention on the operation

If you set up Function1 or Function2 dialog, input data to all boxes. Attention dialog is indicated if you input data or address that is not specified in the datasheet or you click "OK" button before you input data. In that case set up the dialog and input data once more again. These operations does not need if you click "Cancel" button or check the check box.

AK4112B Control Program ver 1.0 operation manual

■ Set-up of evaluation board and control software

This board is used AK4112B as “DIR”. This software must set up when Evaluation of DAC using DSP and Clock Mode selected X’tal.(See P3. (4)).

This evaluation board does not support I²C control.

1. Set up the AKD4626 according to above mentioned setting.
2. Connect IBM-AT compatible PC with AKD4626 by 10-line type flat cable (packed with AKD4626). Take care of the direction of 10pin header. (Please install the driver in the CD-ROM-disk when this control software is used on Windows 2000/XP. Please refer “Installation Manual of Control Software Driver by AKM device control software”. In case of Windows95/98/ME, this installation is not needed. This control software does not operate on Windows NT.)
3. Insert the CD-ROM-disk labeled “AKD4626 Control Program ver 1.0” into the CD-ROM-disk drive.
4. Access the CD-ROM-disk drive and double-click the icon of “akd4112.exe” to set up the control program.
5. Then please evaluate according to the follows.

■ Operation flow

Keep the following flow.

1. Set up the control program.
2. Click “Port Setup” button.
3. Then set up the dialog and input data.

■ Explanation of each buttons

1. [Port Setup] : set up the printer port.
2. [Write default] : initialize the register of AK4112.
3. [All read] : read all registers.
4. [Read] : read data from each register.
5. [Write] : write data to each register.

If you want to write the input data to AK4112, click “OK” button. If not, click “Cancel” button.

■ Indication of data

Input data is indicated on the register map. Red letter indicates “H” or “1” and blue one indicates “L” or “0”. Blank is the part that is not defined in the datasheet.

MEASUREMENT RESULTS

1) ADC part

[Measurement condition]

- Measurement unit: Audio Precision, System two, Cascade
- MCLK : 256fs
- BICK : 64fs
- fs : 48kHz, 96kHz
- BW : 10Hz~20kHz(fs=48kHz), 10Hz~48kHz(fs=96kHz)
- Bit : 24bit
- Power Supply : AVDD=DVDD=5V, TVDD=3.3V
- Interface : DIT(AK4103)
- Temperature : Room

fs=48kHz

Parameter	Input signal	Measurement filter	Lch	Rch
S/(N+D)	1kHz, -0.5dB	20kLPF	95.4dB	95.3dB
DR	1kHz, -60dB	20kLPF	99.1dB	99.3dB
		20kLPF+A-weighted	101.8dB	102.2dB
S/N	no signal	20kLPF	99.5dB	99.4dB
		20kLPF+A-weighted	102.5dB	102.5dB

fs=96kHz

Parameter	Input signal	Measurement filter	Lch	Rch
S/(N+D)	1kHz, -0.5dB	fs/2	93.7dB	93.7dB
DR	1kHz, -60dB	fs/2	97.6dB	97.6dB
		20kHz+A-weighted	104.1dB	104.1dB
S/N	no signal	fs/2	97.7dB	97.7dB
		20kHz+A-weighted	104.3dB	104.4dB

2) DAC part

[Measurement condition]

- Measurement unit : Audio Precision, System two, Cascade(fs=48kHz, 96kHz)
- MCLK : 256fs
- BICK : 64fs
- fs : 48kHz, 96kHz
- BW : 10Hz~22kHz (fs=48kHz), 10Hz~40kHz (fs=96kHz)
- Bit : 24bit
- Power Supply : AVDD=DVDD=5V, TVDD=3.3V
- Interface : DIR(AK4112B)
- Temperature : Room

fs=48kHz

Parameter	Input signal	Measurement filter	Lch	Rch
S/(N+D)	1kHz, -0.5dB	20kLPF	97.7dB	97.4dB
DR	1kHz, -60dB	20kLPF	102.6dB	102.6dB
		22kLPF+A-weighted	105.7dB	105.5dB
S/N	no signal	20kLPF	102.5dB	102.5dB
		22kLPF+A-weighted	105.9dB	105.9dB

fs=96kHz

Parameter	Input signal	Measurement filter	Lch	Rch
S/(N+D)	1kHz, -0.5dB	40kHzLPF	95.6dB	95.6dB
DR	1kHz, -60dB	40kHzLPF	100.6dB	100.7dB
		22kHz+A-weighted	105.5dB	105.5dB
S/N	no signal	40kHz	102.8dB	102.5dB
		22kHz+A-weighted	105.9dB	105.9dB

1.ADC

(ADC fs=48kHz)

AKM

AK4626 ADC FFT (fs=48kHz; fin=1kHz, 0dBFS input)
FFT points=16384, Avg.8 Window=Equiripple

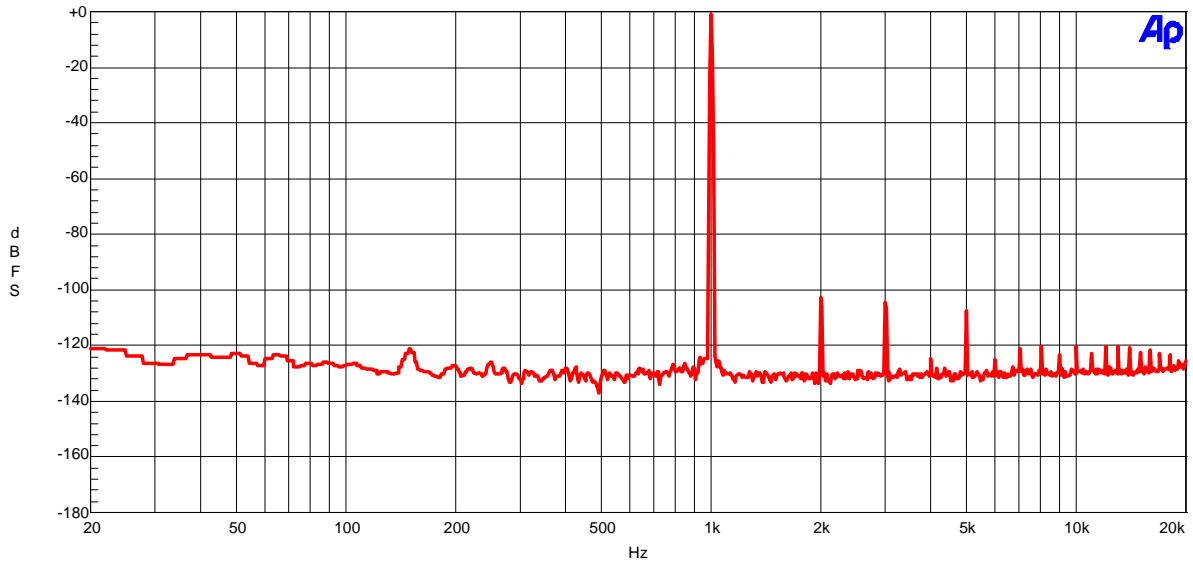

FFT (Input=-0.5dBFS, fin=1kHz)

AKM

AK4626 ADC FFT (fs=48kHz; fin=1kHz, -60dBFS input)
FFT points=16384, Avg.8, Window=Equiripple

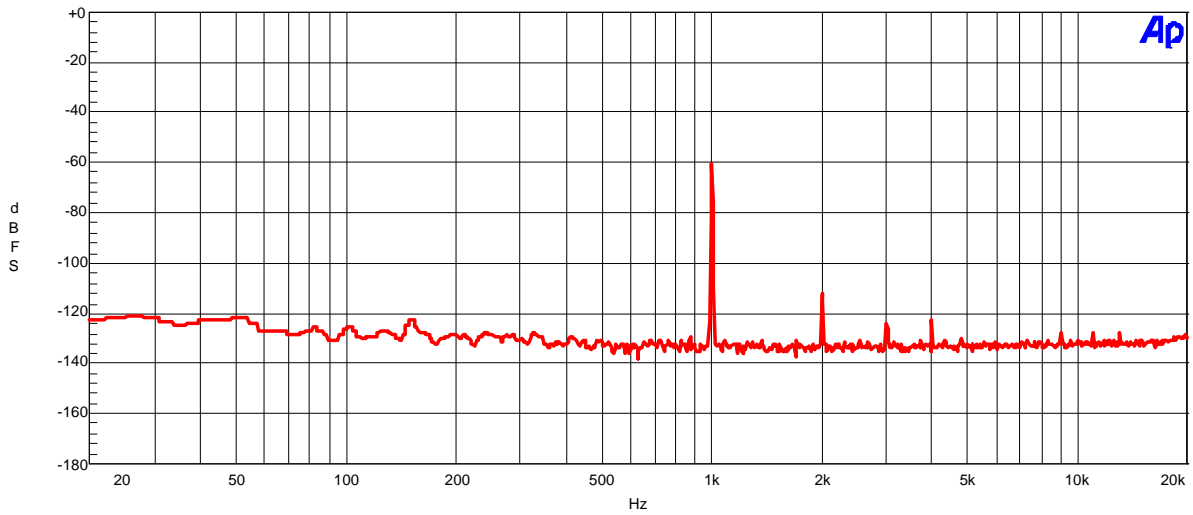

FFT (Input=-60dBFS, fin=1kHz)

(ADC fs=48kHz)

AKM

AK4626 ADC FFT (fs=48kHz; No signal input)
FFT points=16384, Avg.8, Window=Equipple

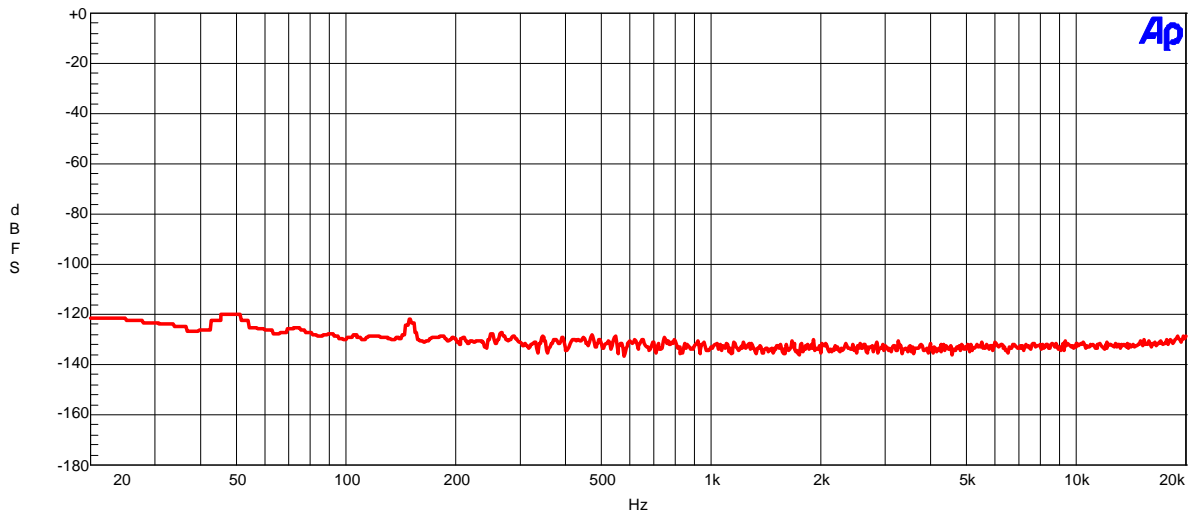

FFT (noise floor)

(ADC fs=48kHz)

AKM

AK4626 ADC THD+N vs. Input Level (fs=48kHz; fin=1kHz)

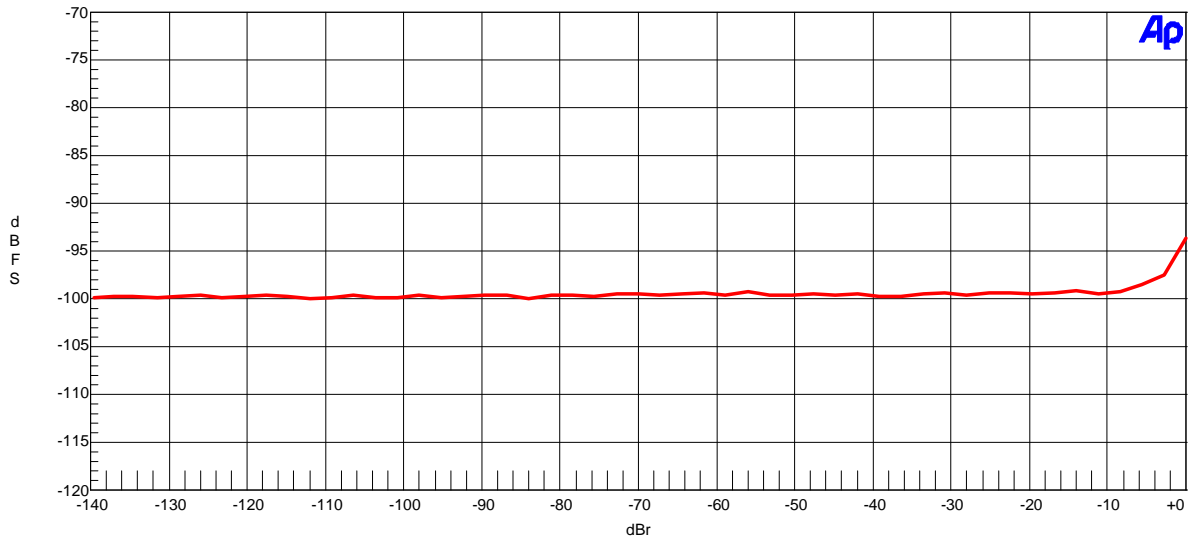

THD + N vs Amplitude (fin=1kHz)

AKM

AK4626 ADC THD+N vs. Input Frequency (fs=48kHz;-0.5dBFS input)

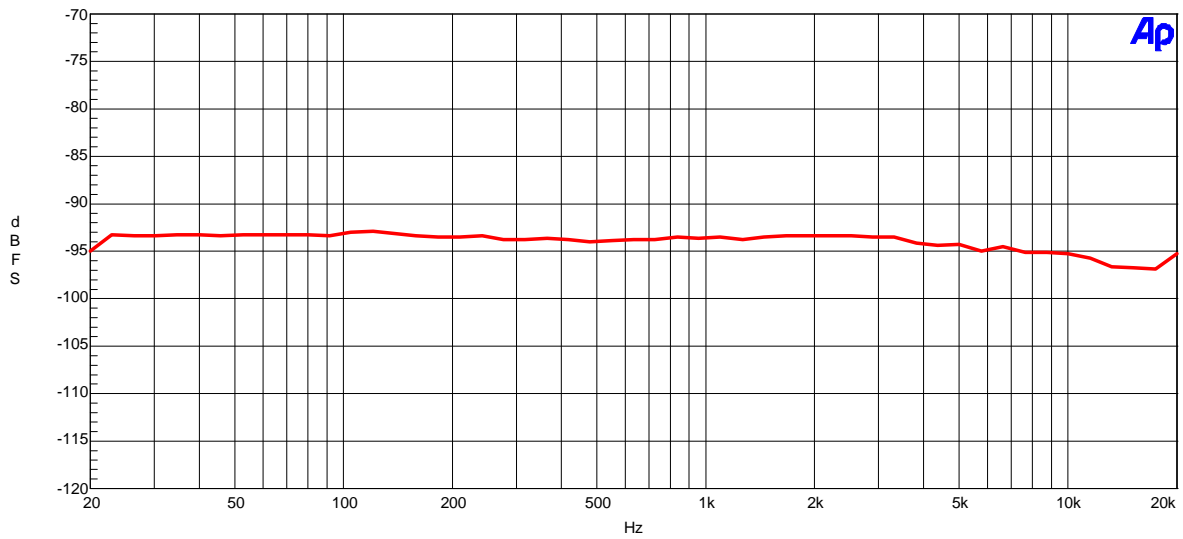

THD + N vs Input Frequency (Input=-0.5dBFS)

(ADC fs=48kHz)

AKM

AK4626 ADC Linearity (fs=48kHz; fin=1kHz)

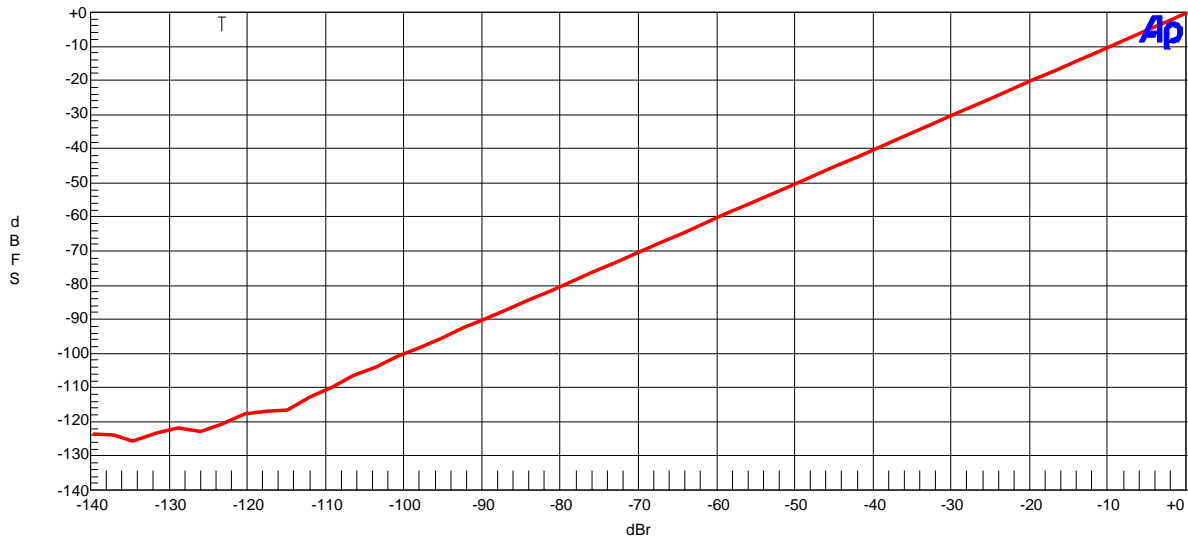

Linearity(fin=1kHz)

AKM

AK4626 ADC Frequency Response (fs=48kHz; -0.5dBFS input)

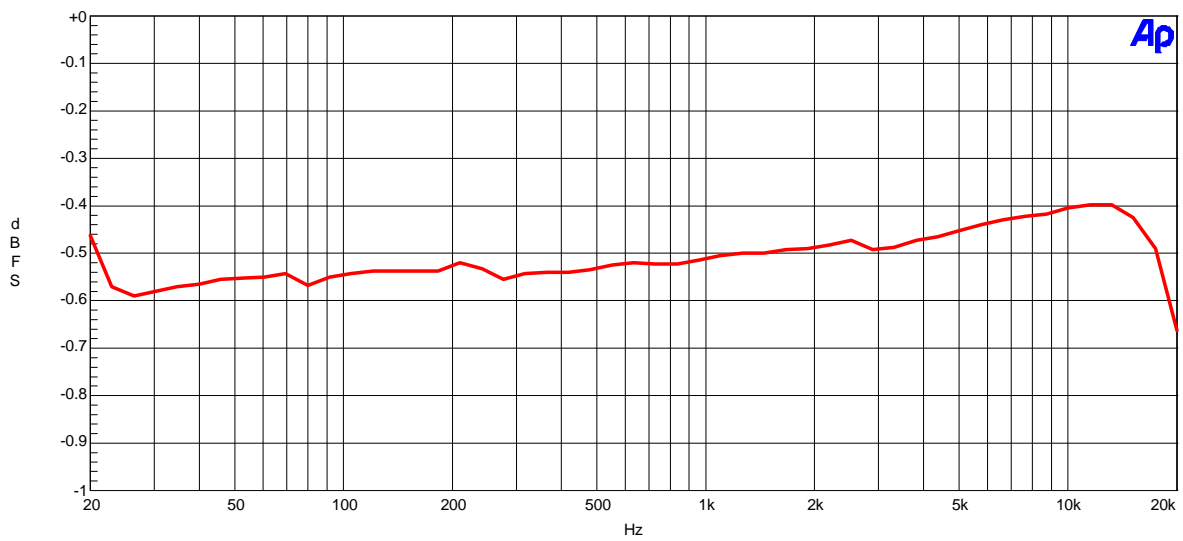

Frequency Response(Input Level=-0.5dBFS)
(including input RC filter)

(ADC fs=48kHz)

AKM

AK4626 ADC Crosstalk (fs=48kHz; -0.5dBFS input)
Upper@1kHz; Lch-->Rch, Lower@1kHz; Rch-->Lch

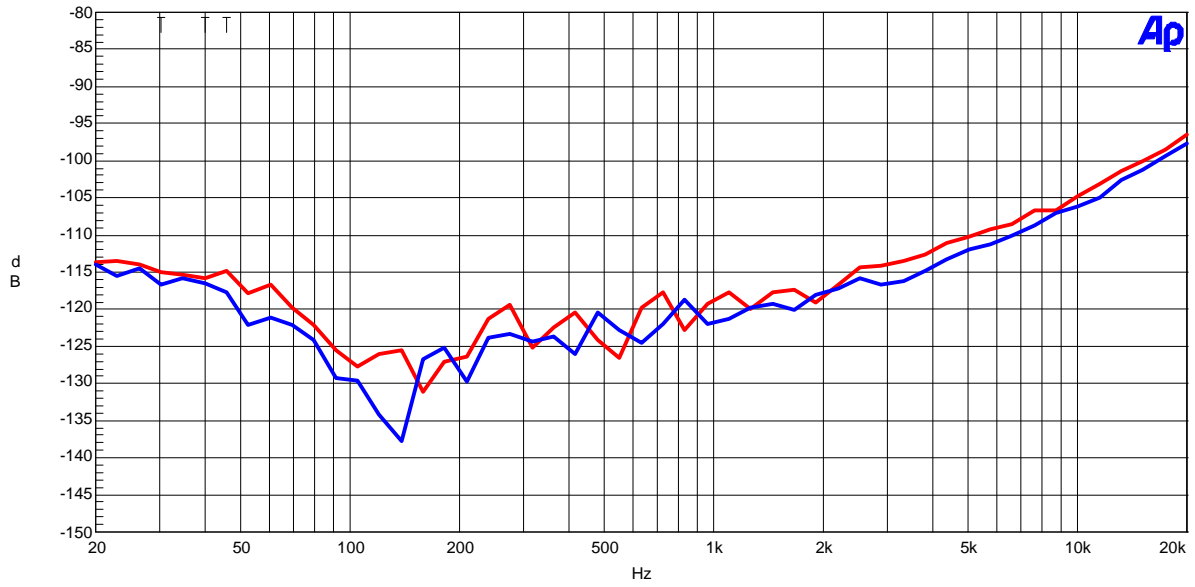

Crosstalk (Upper@1k = Rch, Lower@1k = Lch)

(ADC fs=96kHz)

AKM

AK4626 ADC FFT (fs=96kHz; fin=1kHz, -0.5dBFS Input)
FFT points=16384, Avg.8, Window=Equiripple

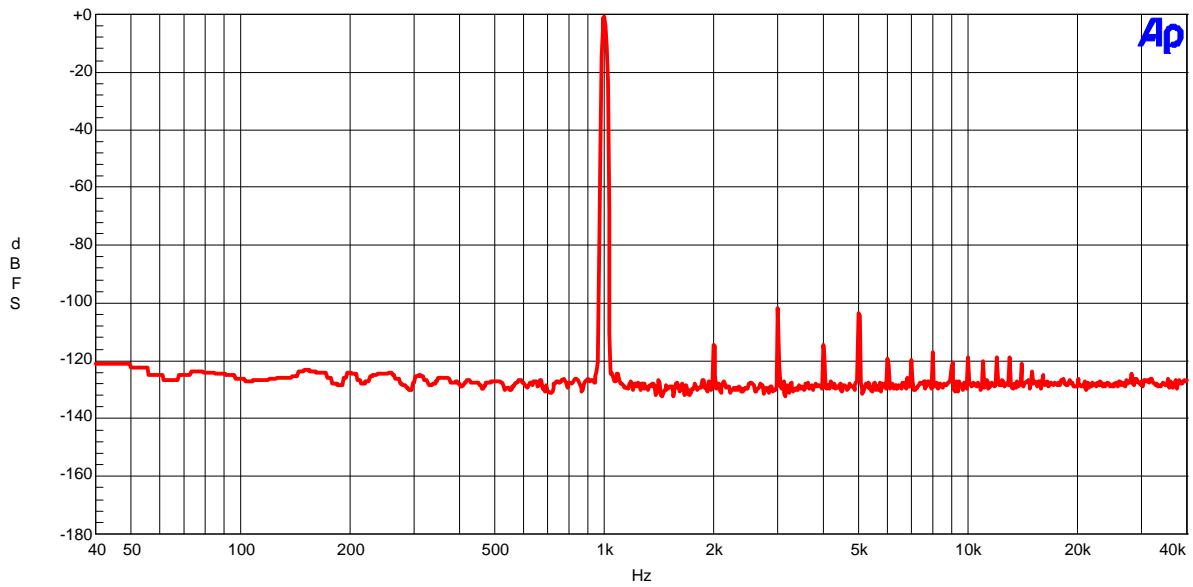

FFT(Input=-0.5dBFS, fin=1kHz)

AKM

AK4626 ADC FFT (fs=96kHz; fin=1kHz, -60dBFS input)
FFT steps=16384, Avg.8, Window=Equiripple

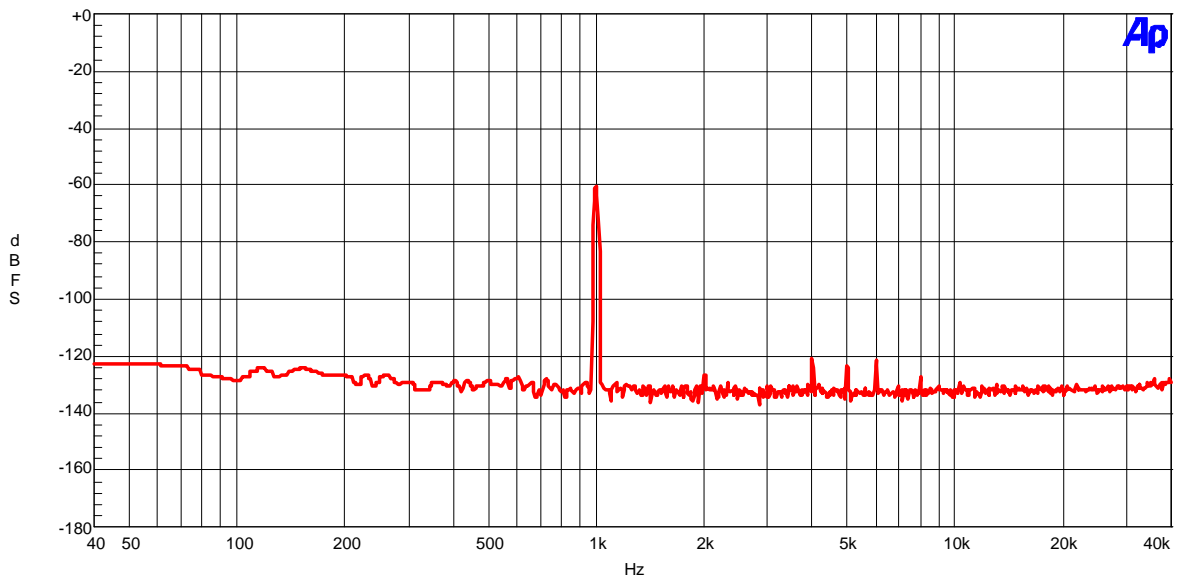

FFT(Input=-60dBFS, fin=1kHz)

(ADC fs=96kHz)

AKM

AK4626 ADC FFT (fs=96kHz; No signal input)
FFT steps=16384, Avg.8, Window=Equiripple

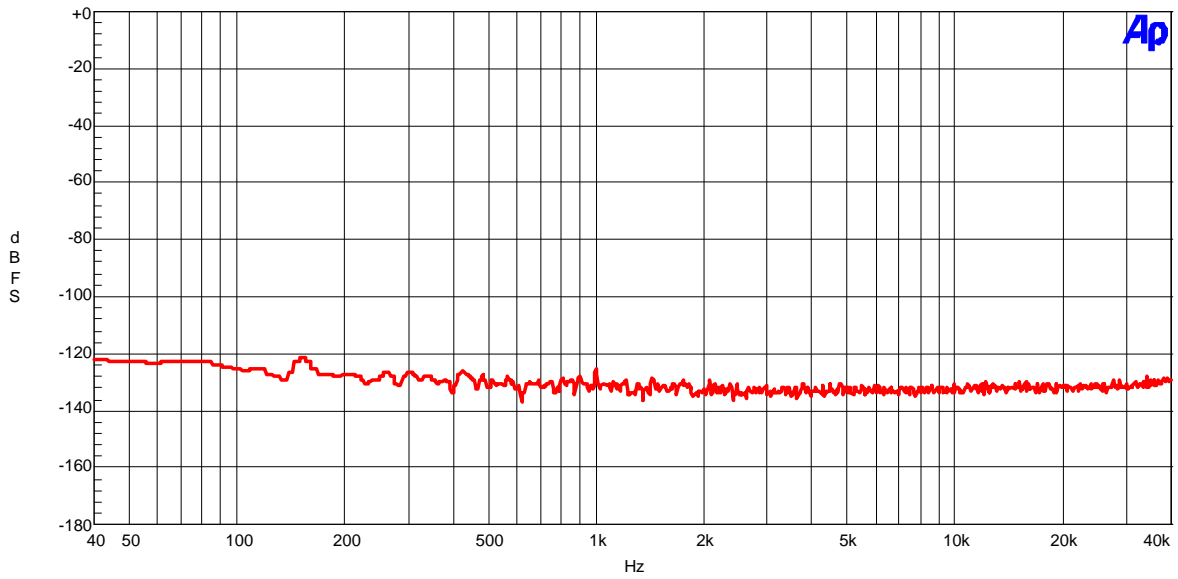

FFT(Noise floor)

(ADC fs=96kHz)

AKM

AK4626 ADC THD+N vs. Input Level (fs=96kHz; fin=1kHz)

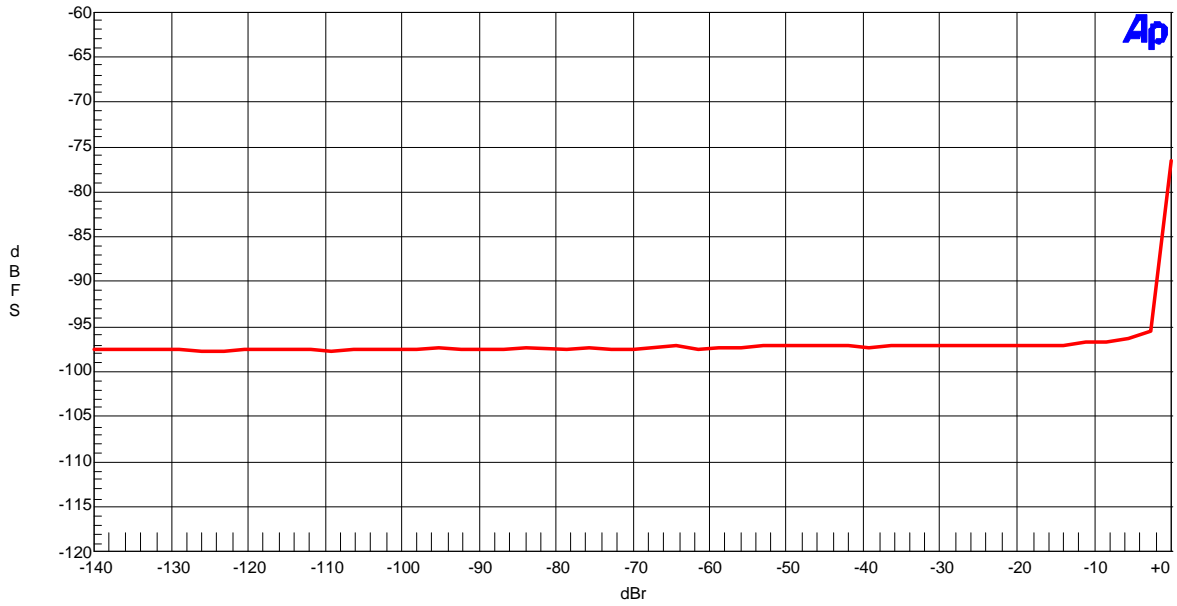

THD + N vs Amplitude(fin=1kHz)

AKM

AK4626 ADC THD+N vs. Input Frequency (fs=96kHz; -0.5dBFS input)

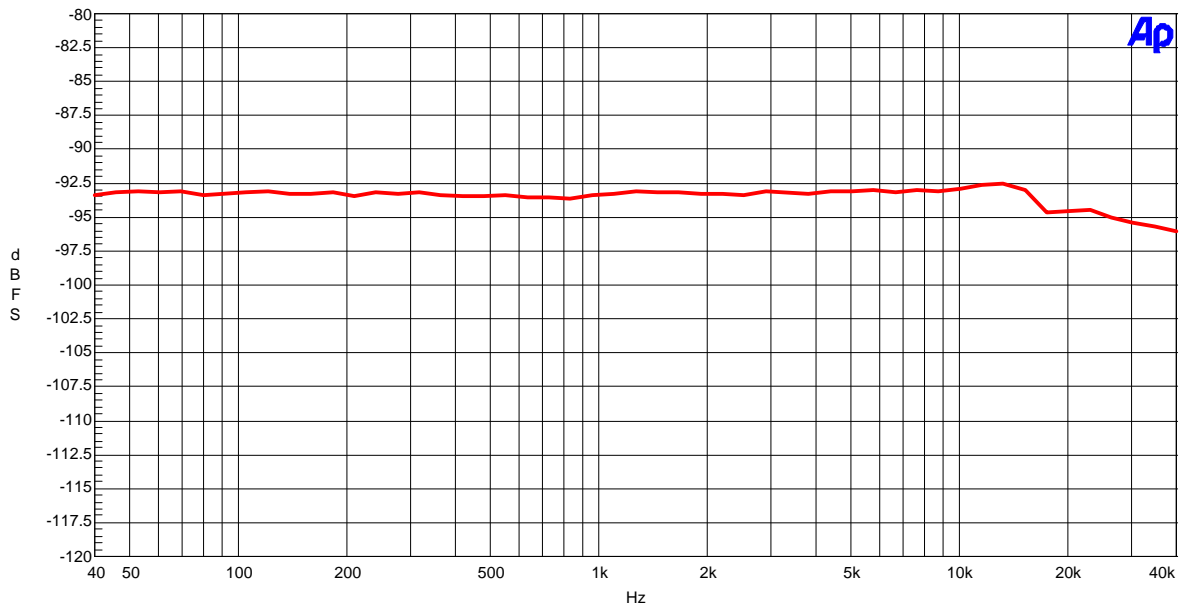

THD + N vs Input Frequency(Input Level=-0.5dBFS)

(ADC fs=96kHz)

AKM

AK4626 ADC Linearity (fs=96kHz; fin=1kHz)

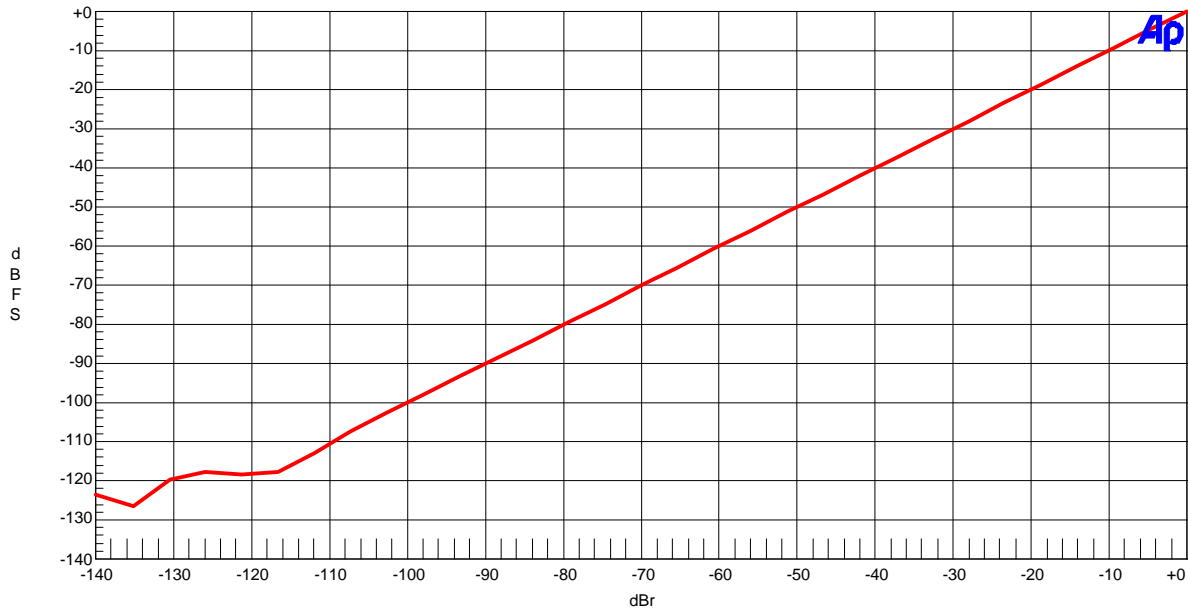

Linearity(fin=1kHz)

AKM

AK4626 ADC Frequency Response (fs=96kHz; -0.5dBFS input)

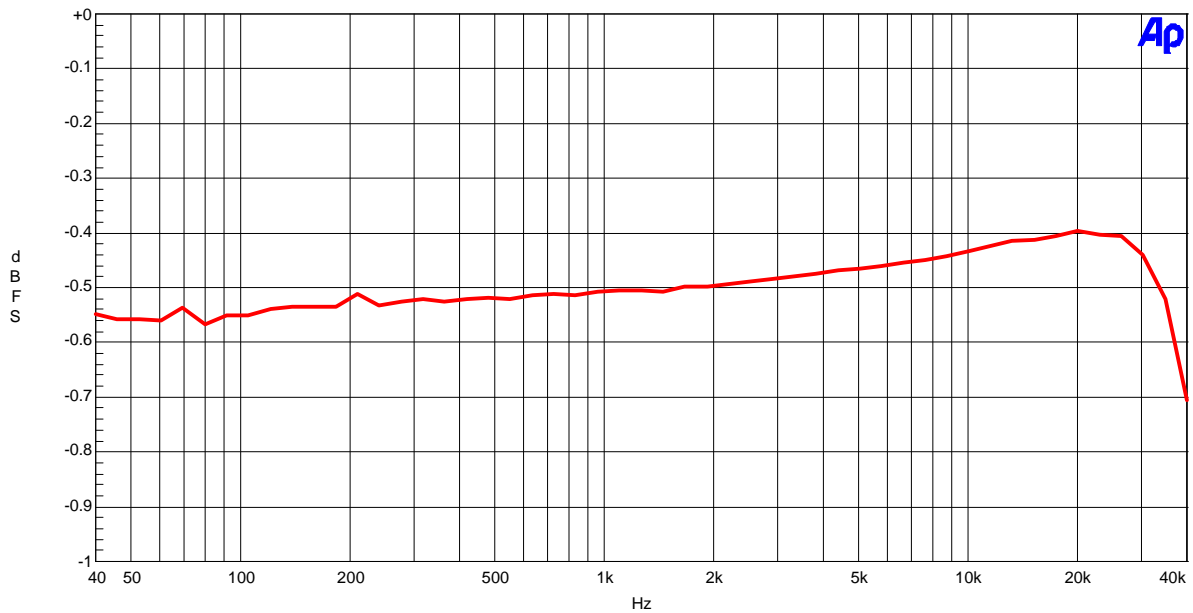

Frequency Response(Input Level=-0.5dBFS)
(including input RC filter)

(ADC fs=96kHz)

AKM

AK4626 ADC Crosstalk (fs=96kHz; -0.5dBFS input)
Upper@1kHz; Lch--->Rch, Lower@1kHz; Rch--->Lch

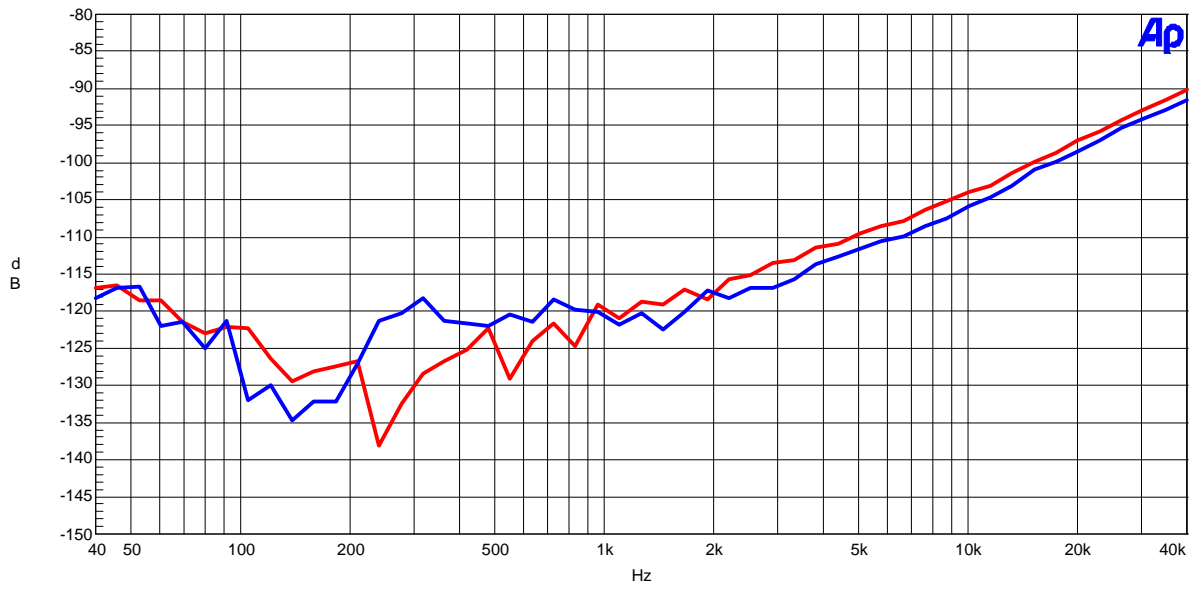

Crosstalk (Upper = Rch, Lower = Lch)

2.DAC

(DAC fs=48kHz)

AKM

AK4626 DAC FFT (fs=48kHz, fin=1kHz, 0dBFS input)

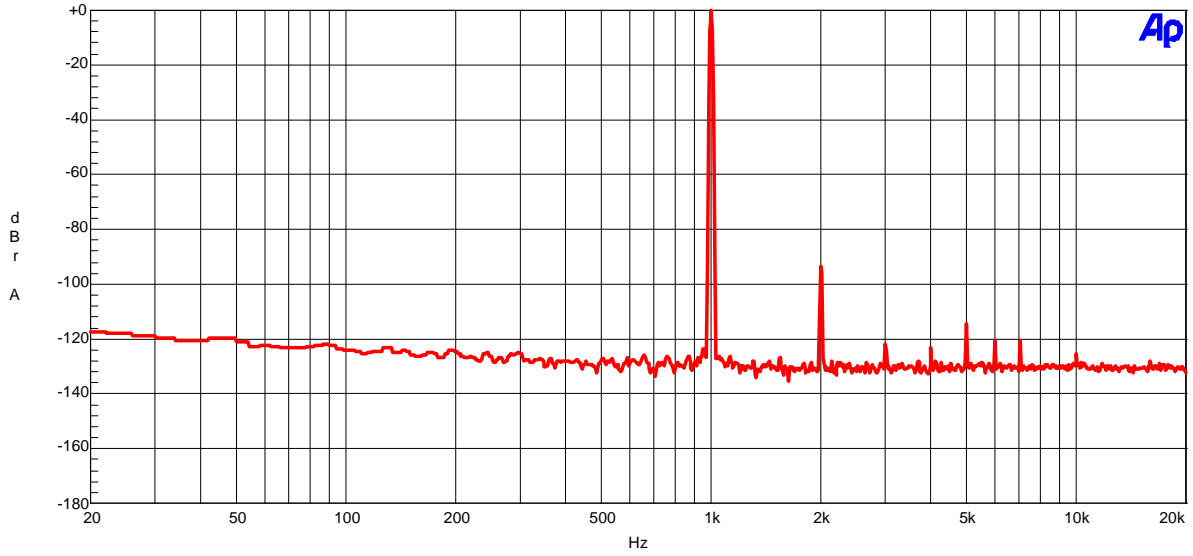

FFT (Input=0dBFS, fin=1kHz)

AKM

AK4626 DAC FFT (fs=48kHz; fin=1kHz, -60dBFS input)
FFT points=16384, Avg.8, Window=Equiripple

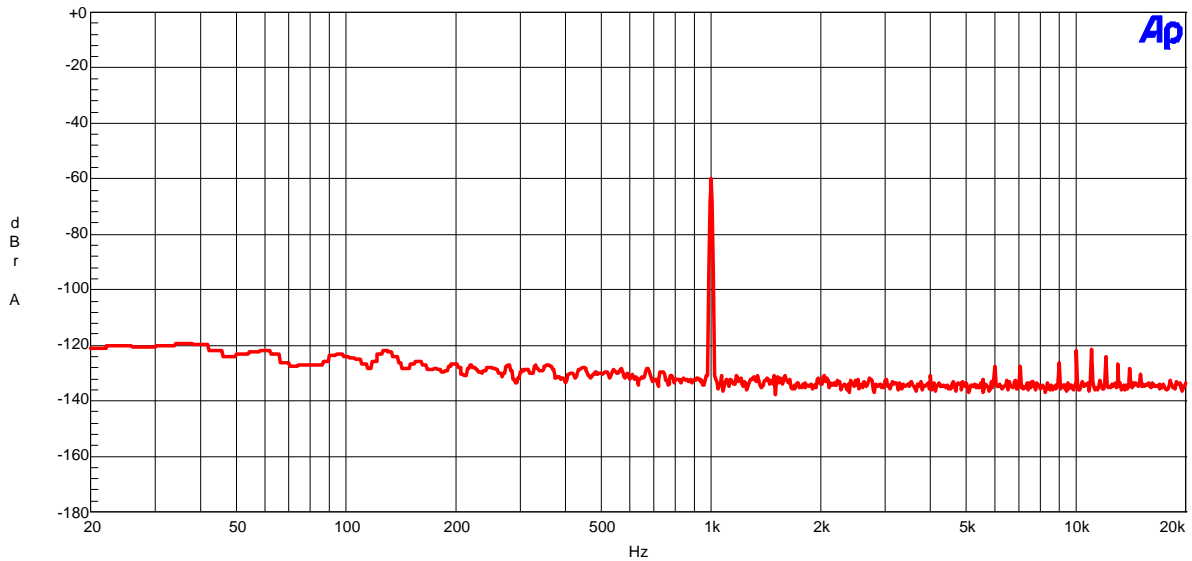

FFT (Input=-60dBFS, fin=1kHz)

(DAC fs=48kHz)

AKM

AK4626 DAC FFT (No data input)
FFT points=16384, Avg.8, Window=Equiripple

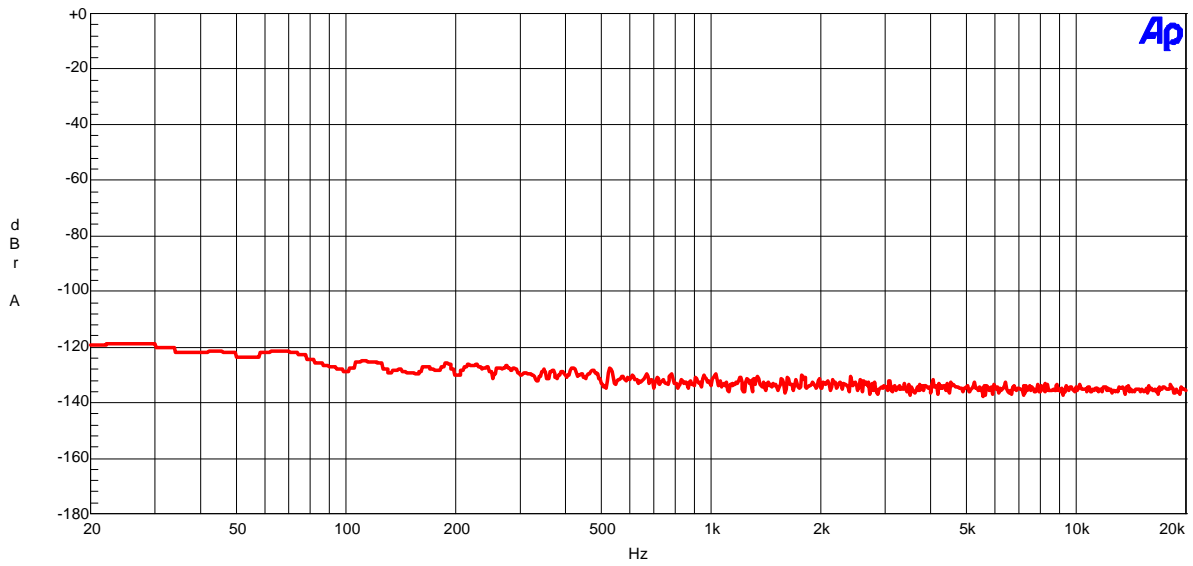

FFT (Noise floor)

AKM

AK4626 DAC FFT (Outband Noise)
FFT points=16384, Avg.8, Window=Equiripple

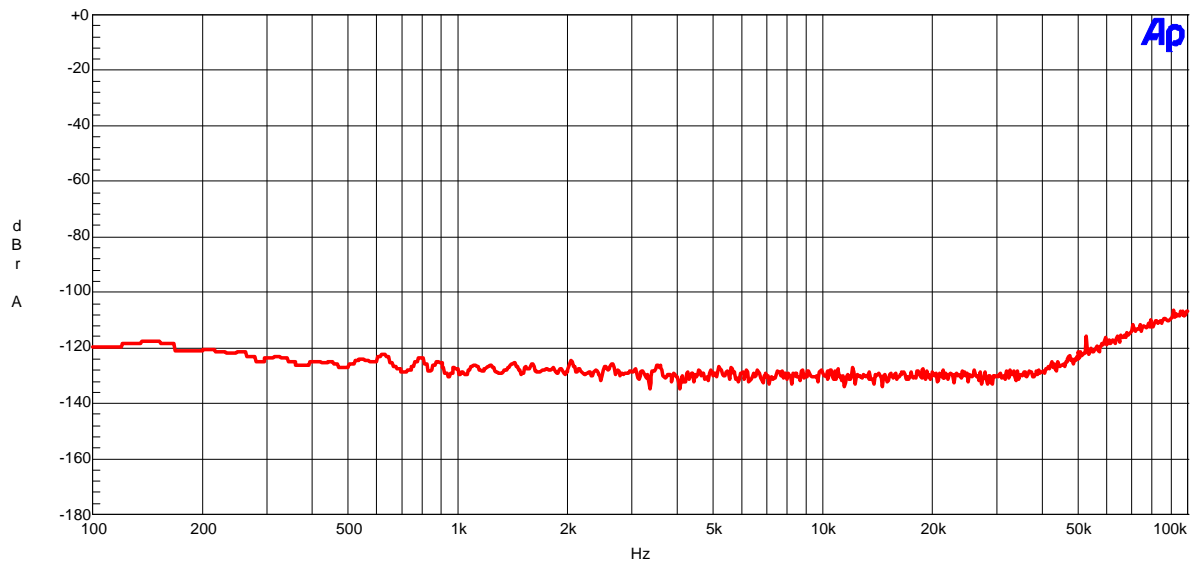

FFT (Outband noise)

(DAC fs=48kHz)

AKM

AK4626 DAC THD+N vs. Input Level (fs=48kHz, fin=1kHz)

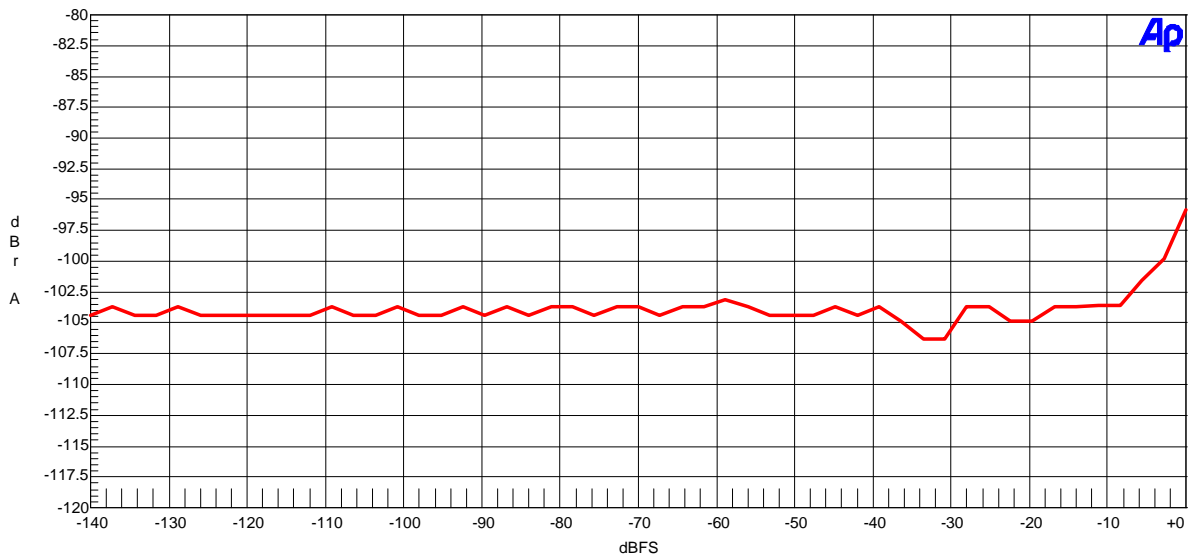

THD + N vs Amplitude(fin=1kHz)

AKM

AK4626 DAC THD+N vs. fin (fs=48kHz, 0dBFS input)

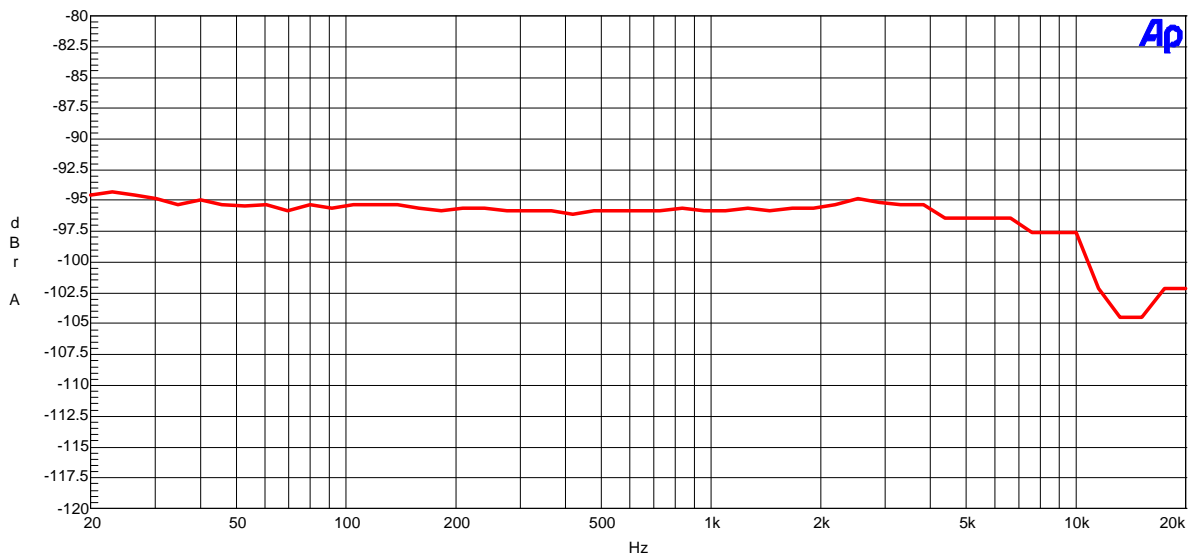

THD + N vs Input Frequency (Input=0dBFS)

(DAC fs=48kHz)

AKM

AK4626 DAC Linearity (fs=48kHz, fin=1kHz)

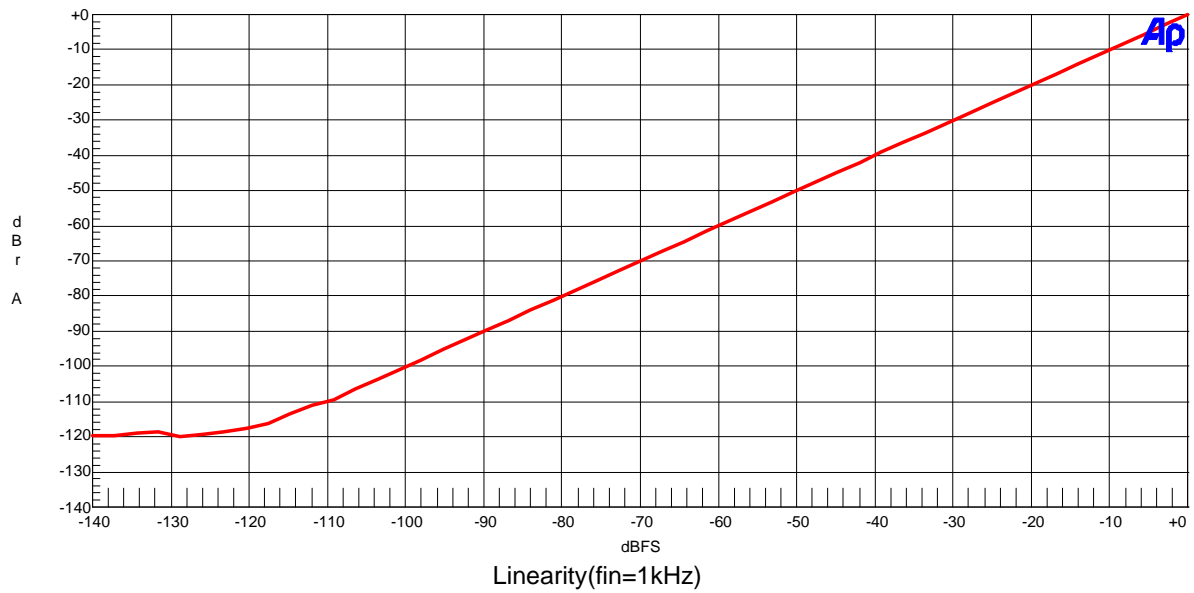

AKM

AK4626 DAC Frequency Response (fs=48kHz, 0dBFS Input)

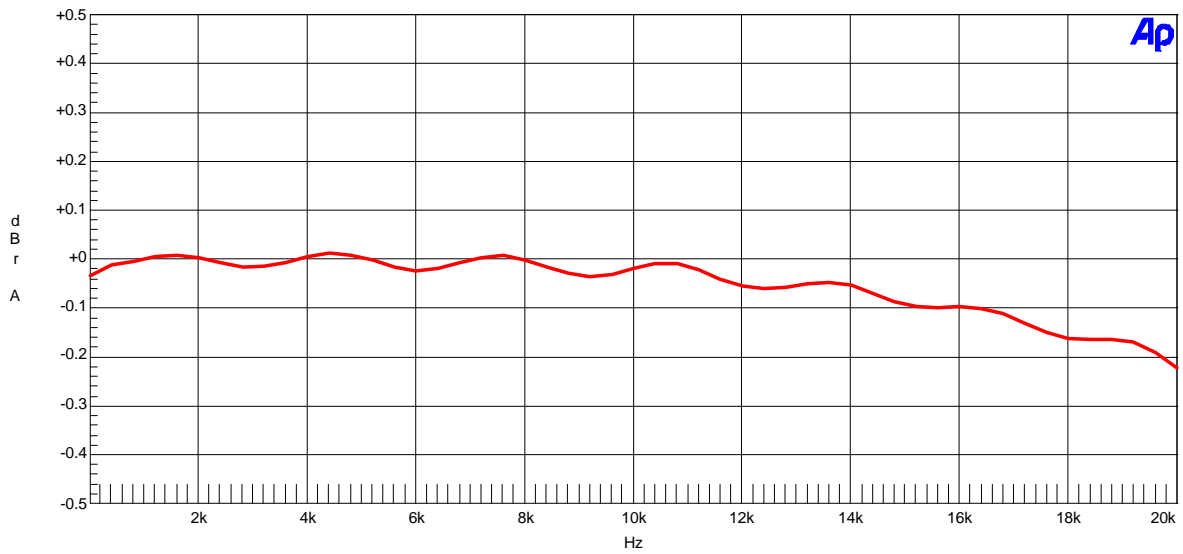

Frequency Response(Input Level=0dBFS)
(including external RC filter)

(DAC fs=48kHz)

AKM

AK4626 DAC Crosstalk (fs=48kHz, 0dBFS Input)
Upper@1kHz; Lch--->Rch, Lower@1kHz; Rch--->Lch

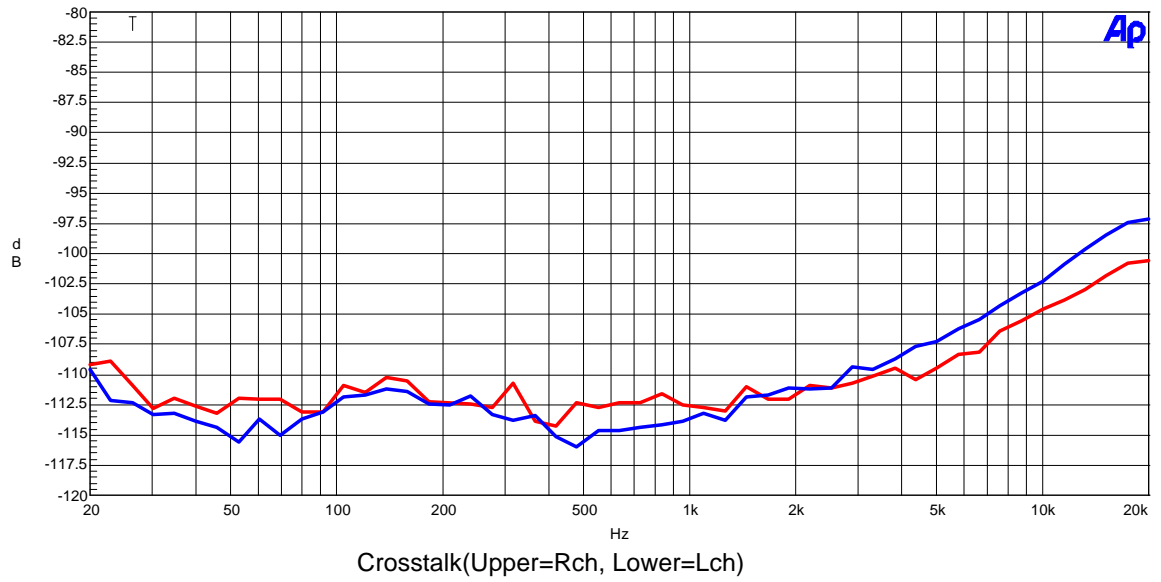

(DAC fs=96kHz)

AKM

AK4626 DAC FFT (fs=96kHz; fin=1kHz -0.5dBFS input; Notch; on)

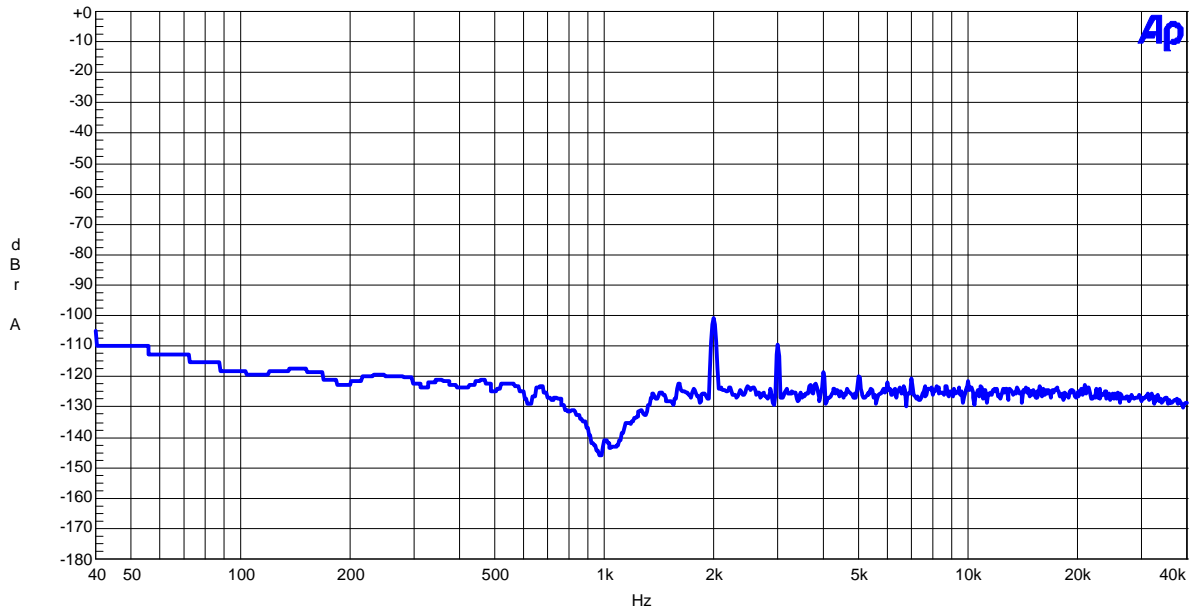

FFT (Input=0dBFS, fin=1kHz, Notch)

AKM

AK4626 DAC FFT (fs=96kHz; fin=1kHz, -60dBFS input)

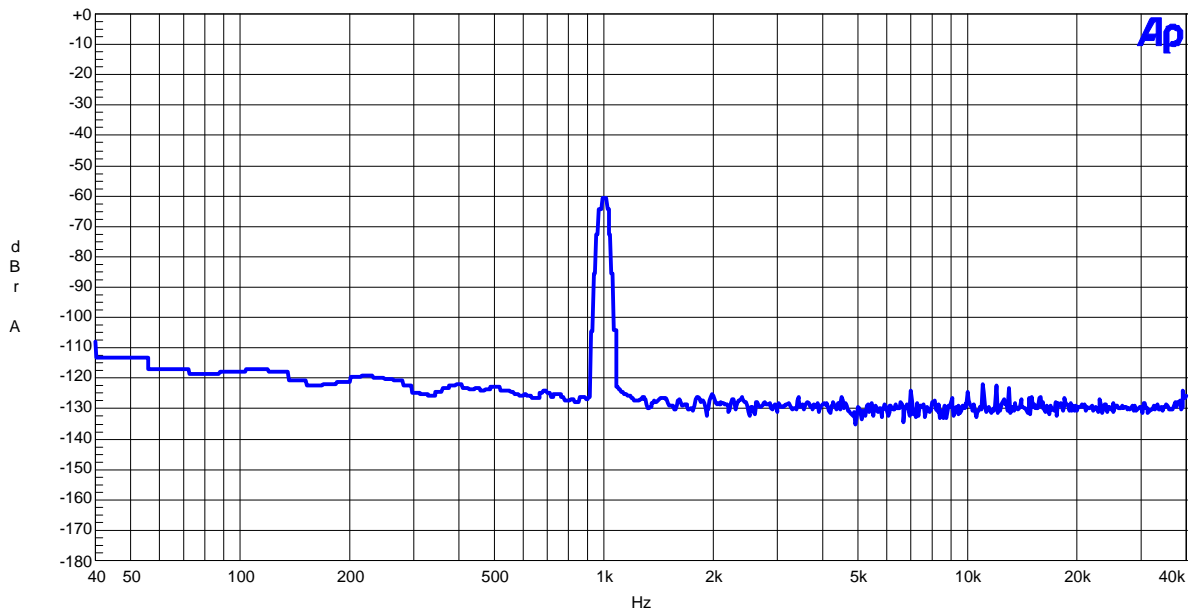

FFT (Input=-60dBFS, fin=1kHz)

(DAC fs=96kHz)

AKM

AK4626 DAC FFT (fs=96kHz; No data input)

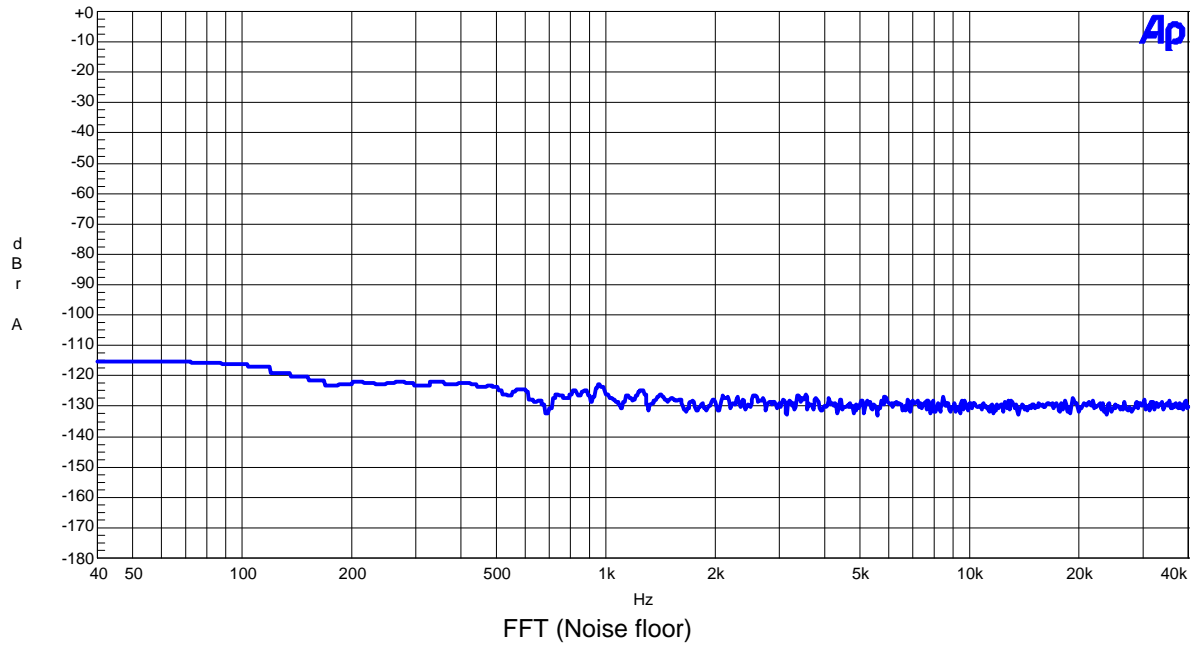

AKM

AK4626 DAC FFT (Out of Band Noise)

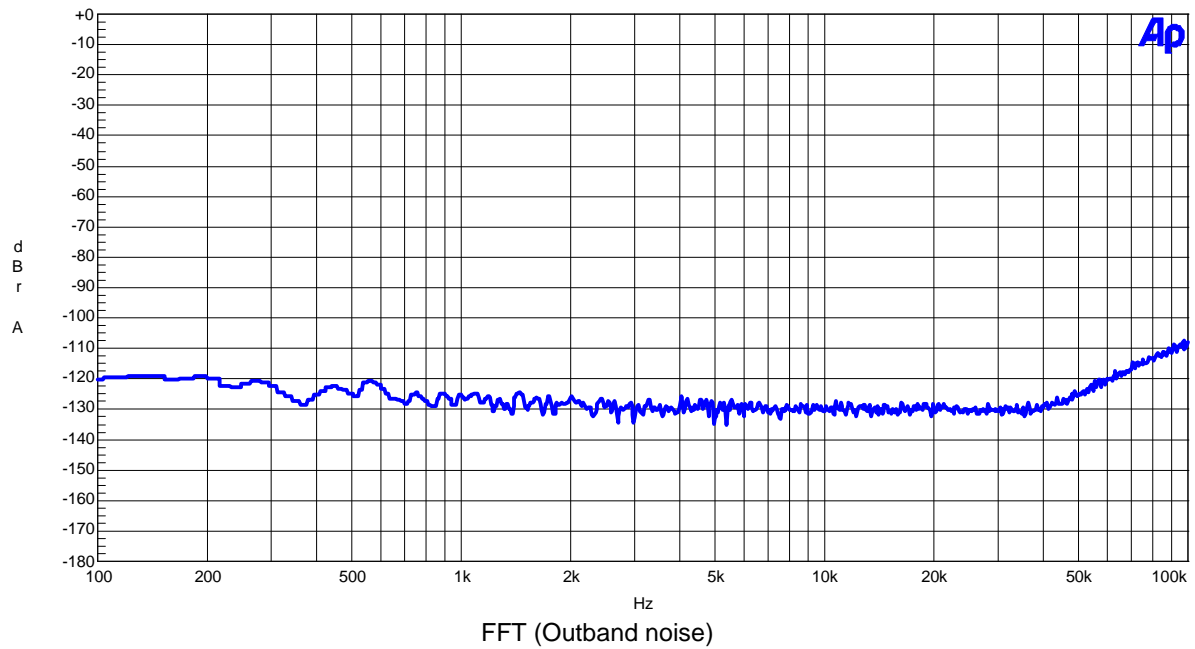

(DAC fs=96kHz)

AKM

AK4626 DAC THD+N vs. Input Level (fs=96kHz; fin=1kHz)

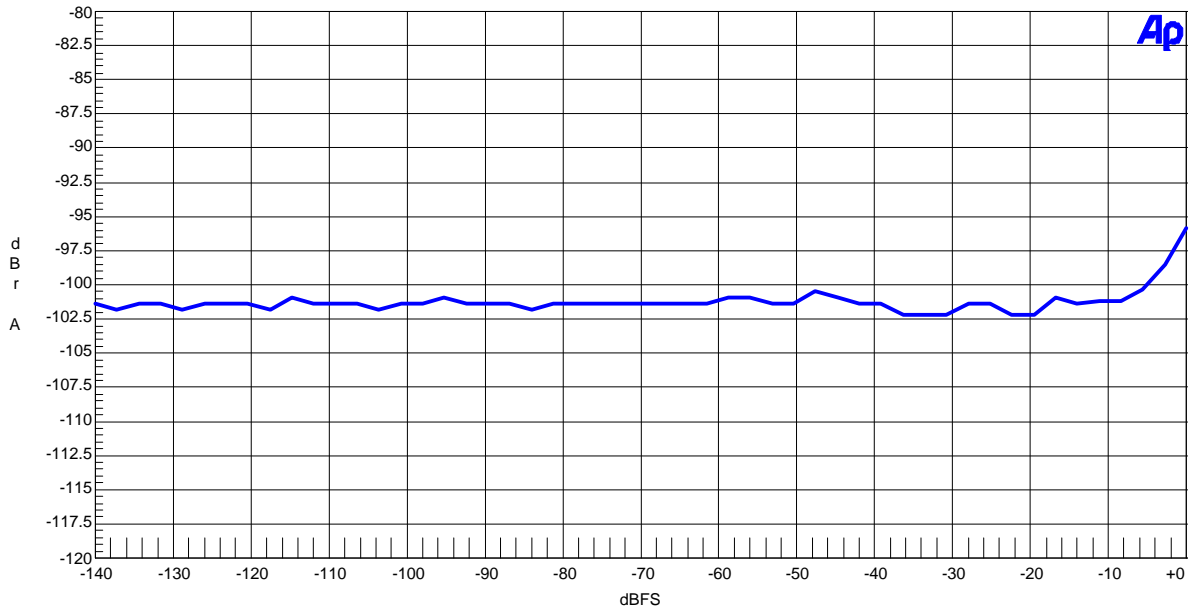

THD + N vs Amplitude (fin=1kHz)

AKM

AK4626 DAC THD+N vs. Input Frequency (fs=96kHz; -0.5dBFS input)

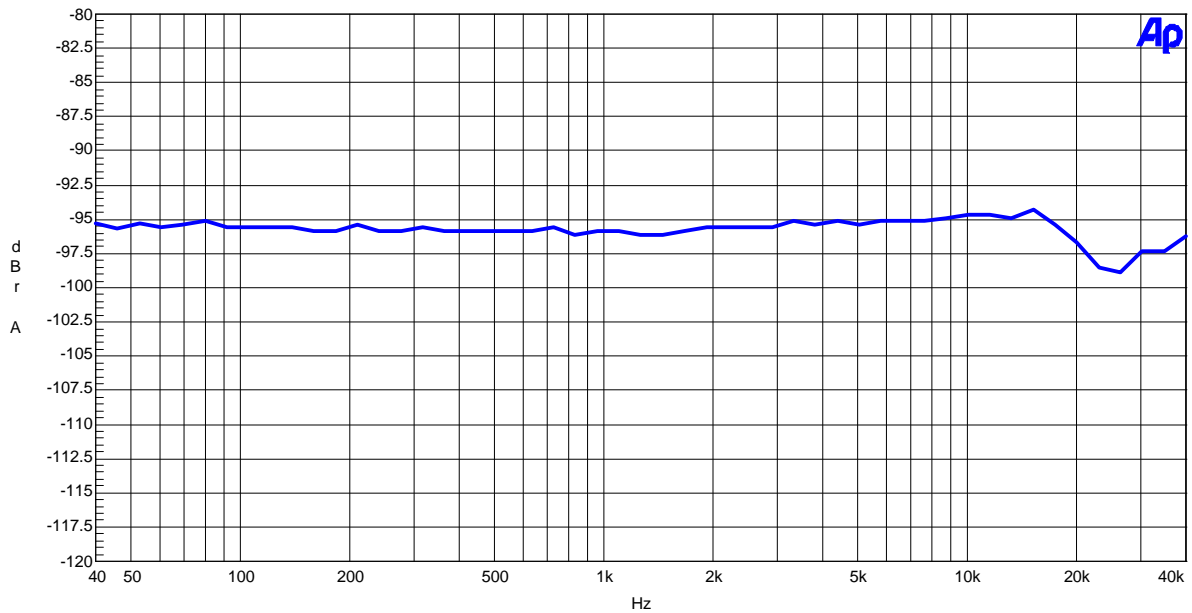

THD + N vs Input Frequency (Input=0dBFS)

(DAC fs=96kHz)

AKM

AK4626 DAC Linearity (fs=96kHz; fin=1kHz)

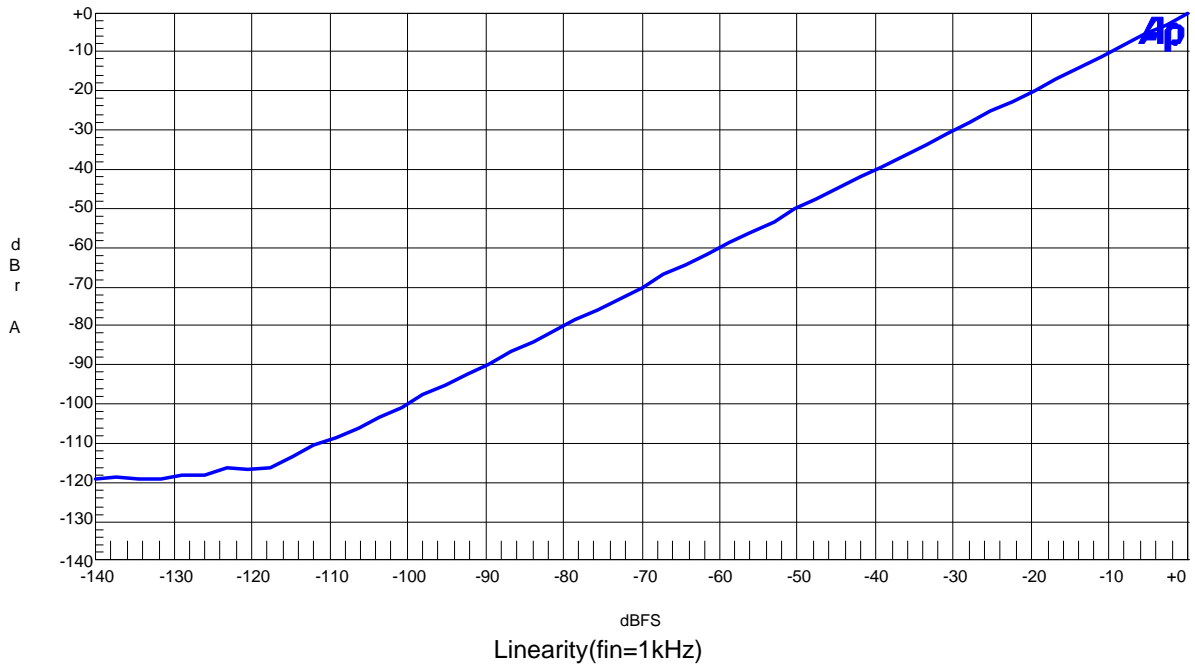

AKM

AK4626 DAC Frequency Response (fs=96kHz; 0dBFS input)

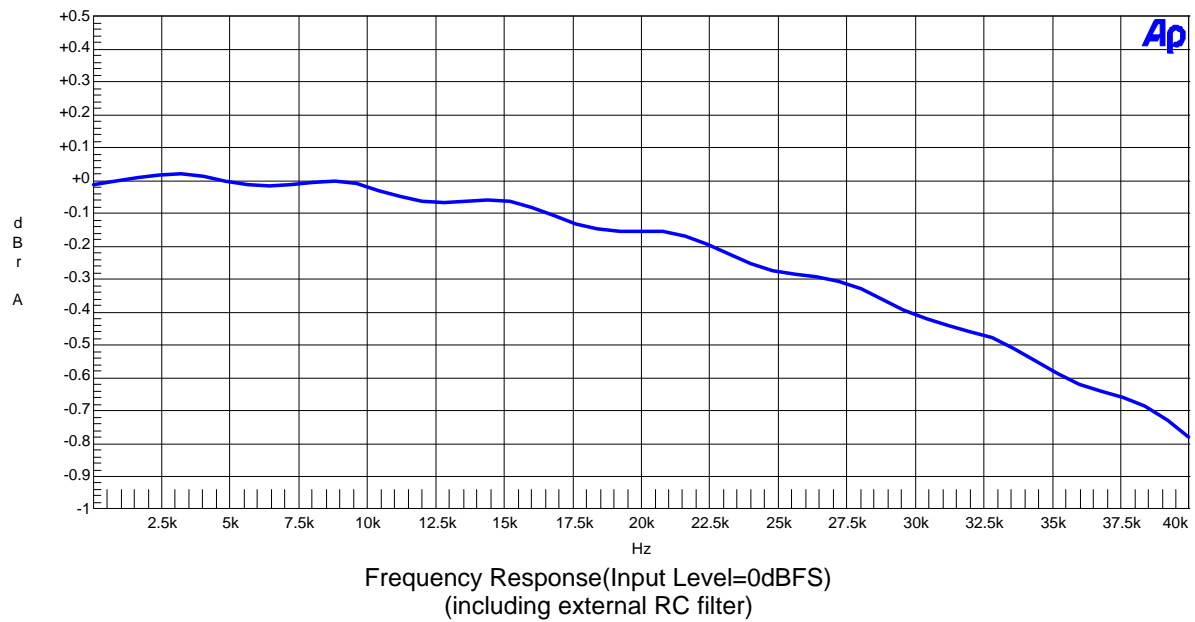

(DAC fs=96kHz)

AKM

AK4626 DAC Crosstalk (fs=96kHz; 0dBFS input)
Upper@1kHz; Lch--->Rch, Lower@1kHz; Rch--->Lch

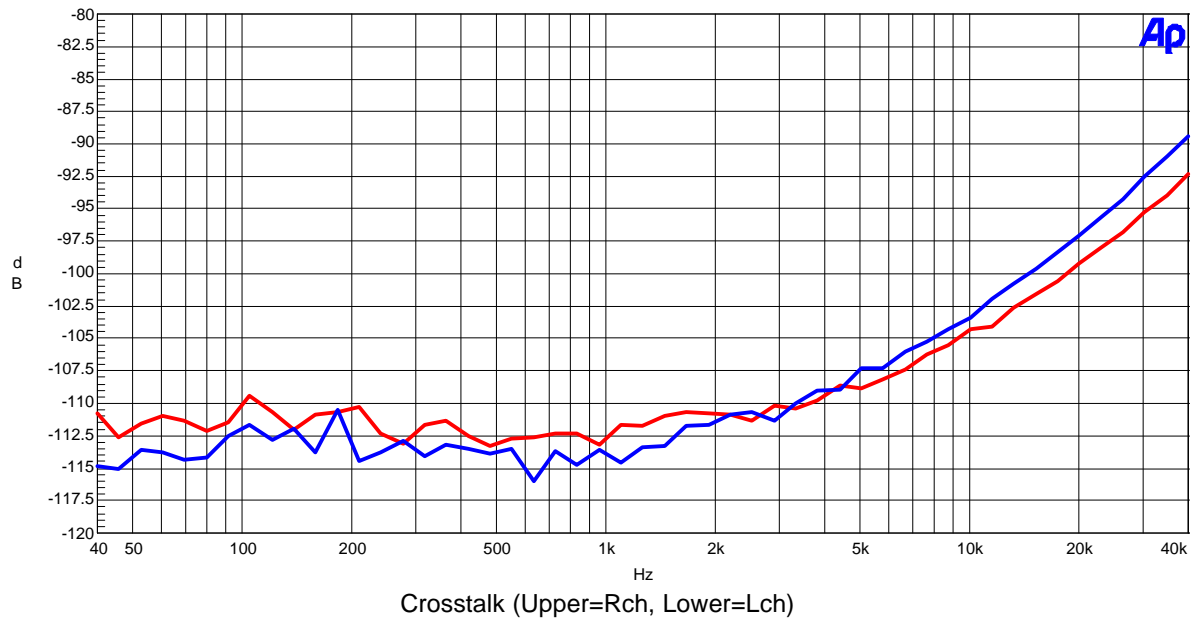

IMPORTANT NOTICE

- These products and their specifications are subject to change without notice. Before considering any use or application, consult the Asahi Kasei Microsystems Co., Ltd. (AKM) sales office or authorized distributor concerning their current status.
- AKM assumes no liability for infringement of any patent, intellectual property, or other right in the application or use of any information contained herein.
- Any export of these products, or devices or systems containing them, may require an export license or other official approval under the law and regulations of the country of export pertaining to customs and tariffs, currency exchange, or strategic materials.
- AKM products are neither intended nor authorized for use as critical components in any safety, life support, or other hazard related device or system, and AKM assumes no responsibility relating to any such use, except with the express written consent of the Representative Director of AKM. As used here:
 - (a) A hazard related device or system is one designed or intended for life support or maintenance of safety or for applications in medicine, aerospace, nuclear energy, or other fields, in which its failure to function or perform may reasonably be expected to result in loss of life or in significant injury or damage to person or property.
 - (b) A critical component is one whose failure to function or perform may reasonably be expected to result, whether directly or indirectly, in the loss of the safety or effectiveness of the device or system containing it, and which must therefore meet very high standards of performance and reliability.
- It is the responsibility of the buyer or distributor of an AKM product who distributes, disposes of, or otherwise places the product with a third party to notify that party in advance of the above content and conditions, and the buyer or distributor agrees to assume any and all responsibility and liability for and hold AKM harmless from any and all claims arising from the use of said product in the absence of such notification.

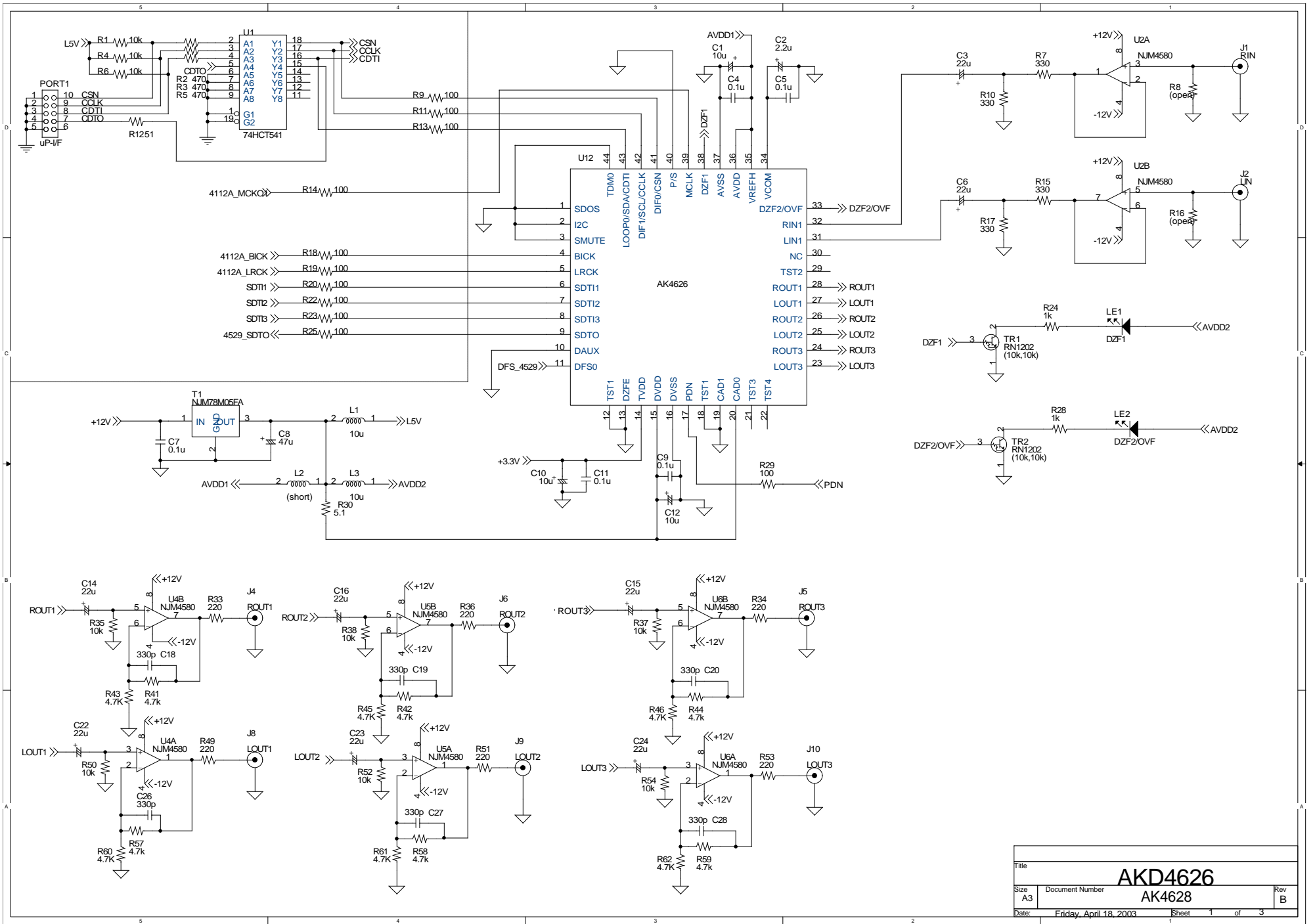

Title		
AKD4626		
Size	Document Number	Rev
A3	AK4628	B
Date:	Friday, April 18, 2003	Sheet 1 of 3

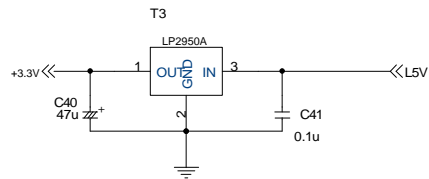
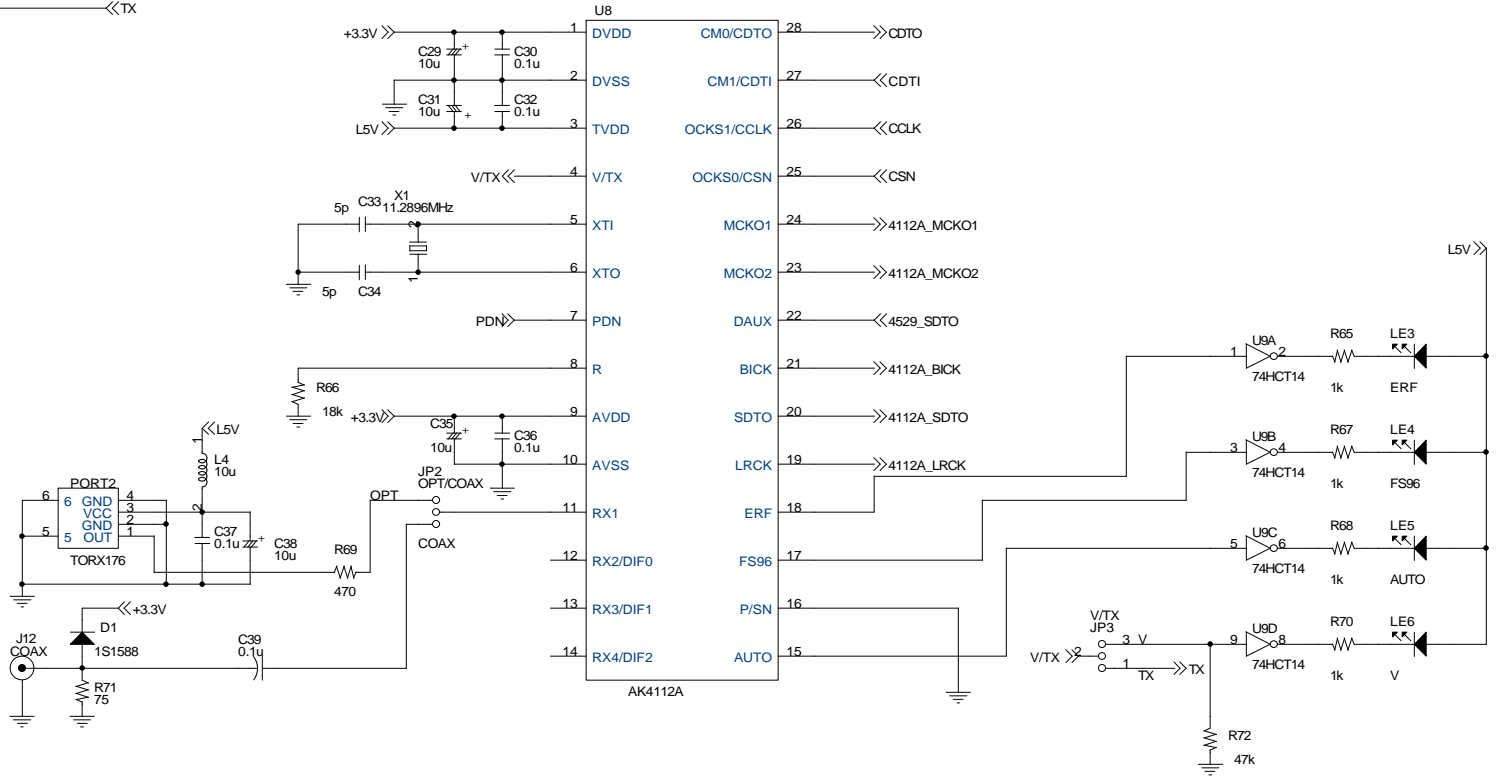
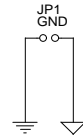
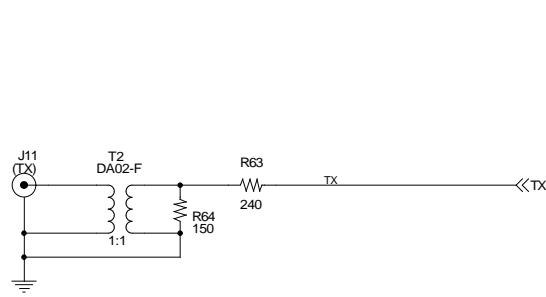

Title			AKD4626		
Size	Document Number		Rev		
A3	AK4112		B		
Date:	Friday, April 18, 2003		Sheet	2	of 3

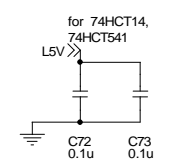
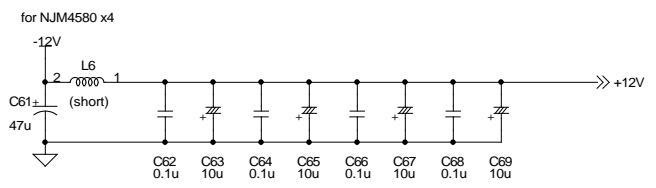
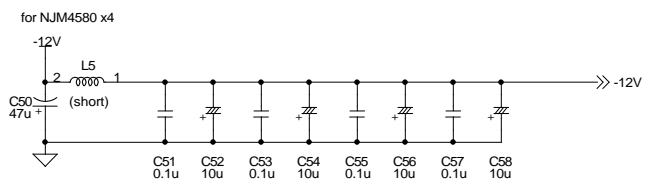
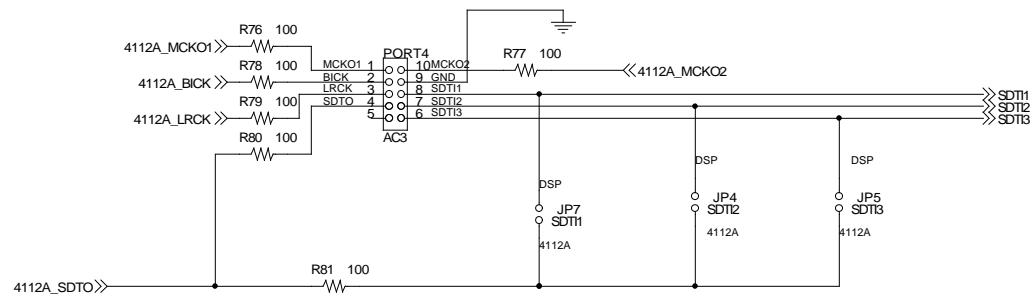
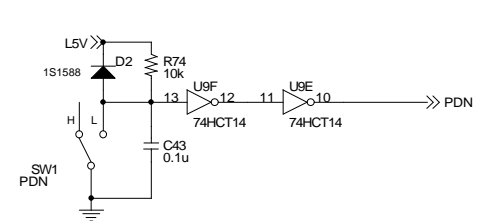
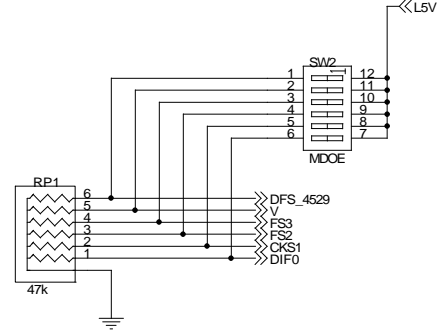
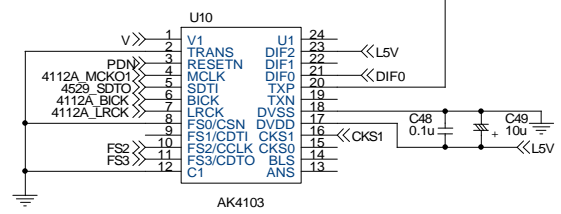
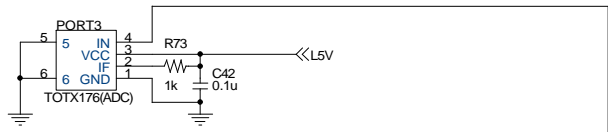

Title		AKD4626	
Size	A3	Document Number	Interface
Date:	Friday, April 18, 2003	Sheet	3 of 3
		Rev	B

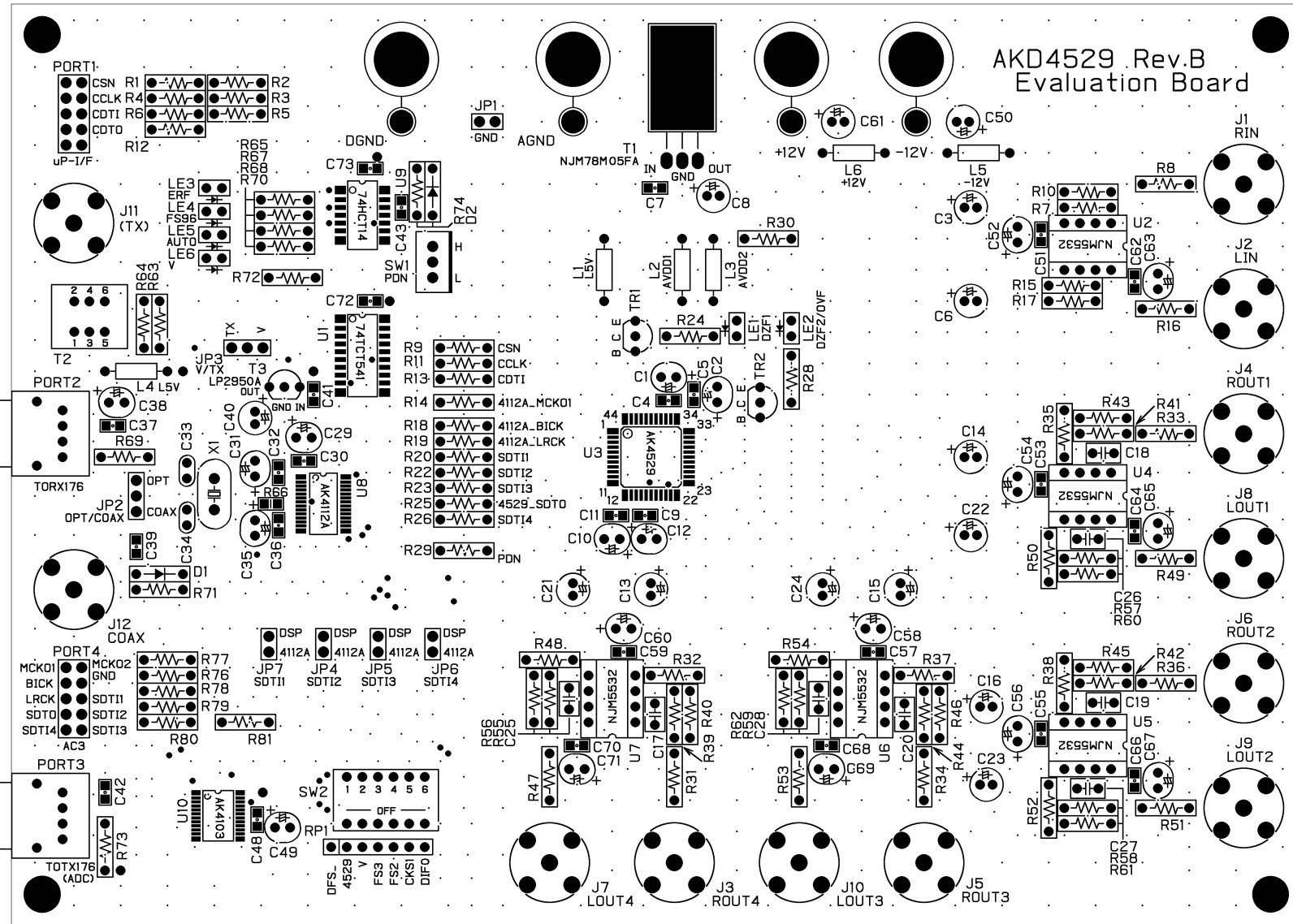

AKD4529 Rev.B L1 SR SILK

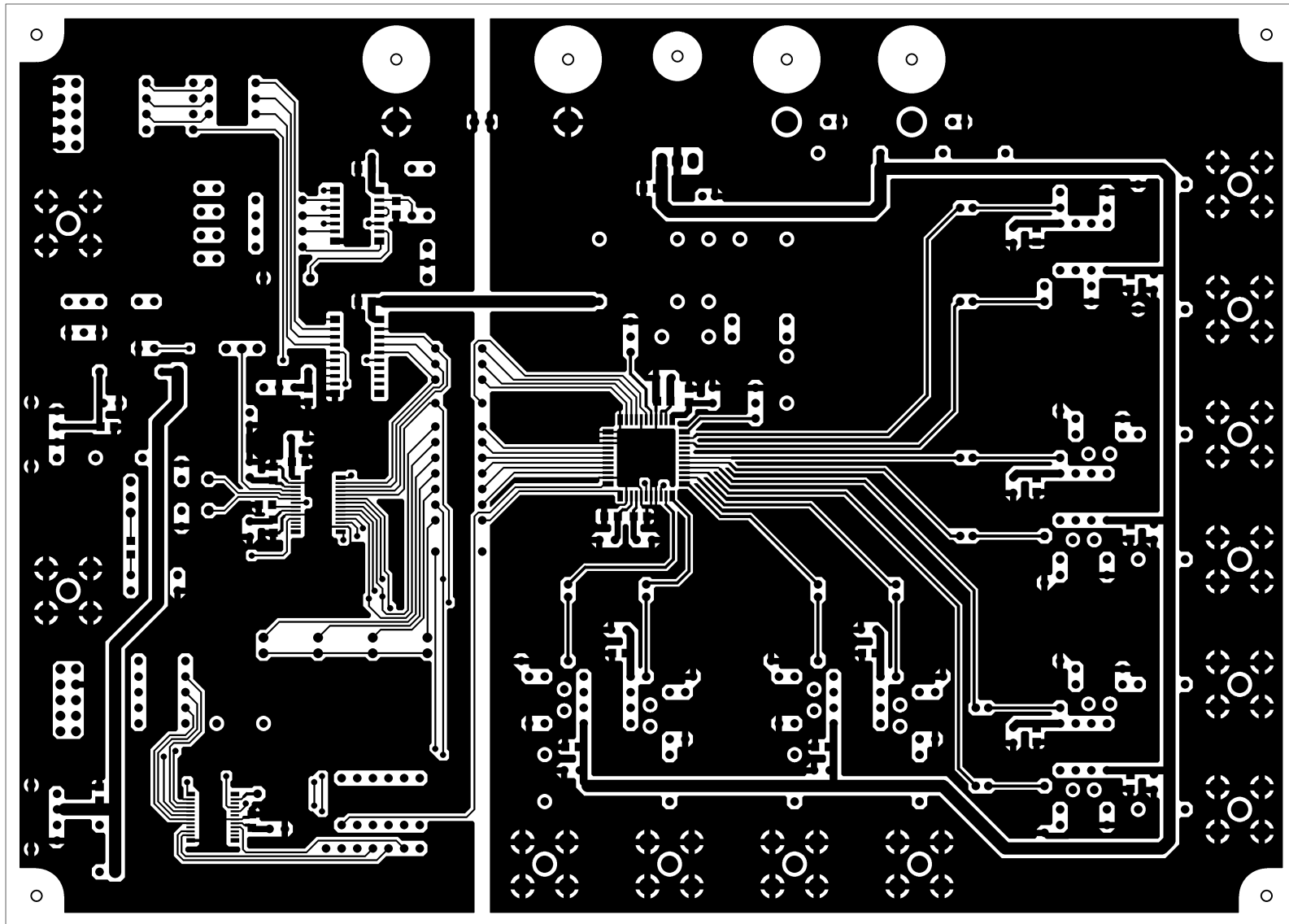

AKD4529 Rev.B L1

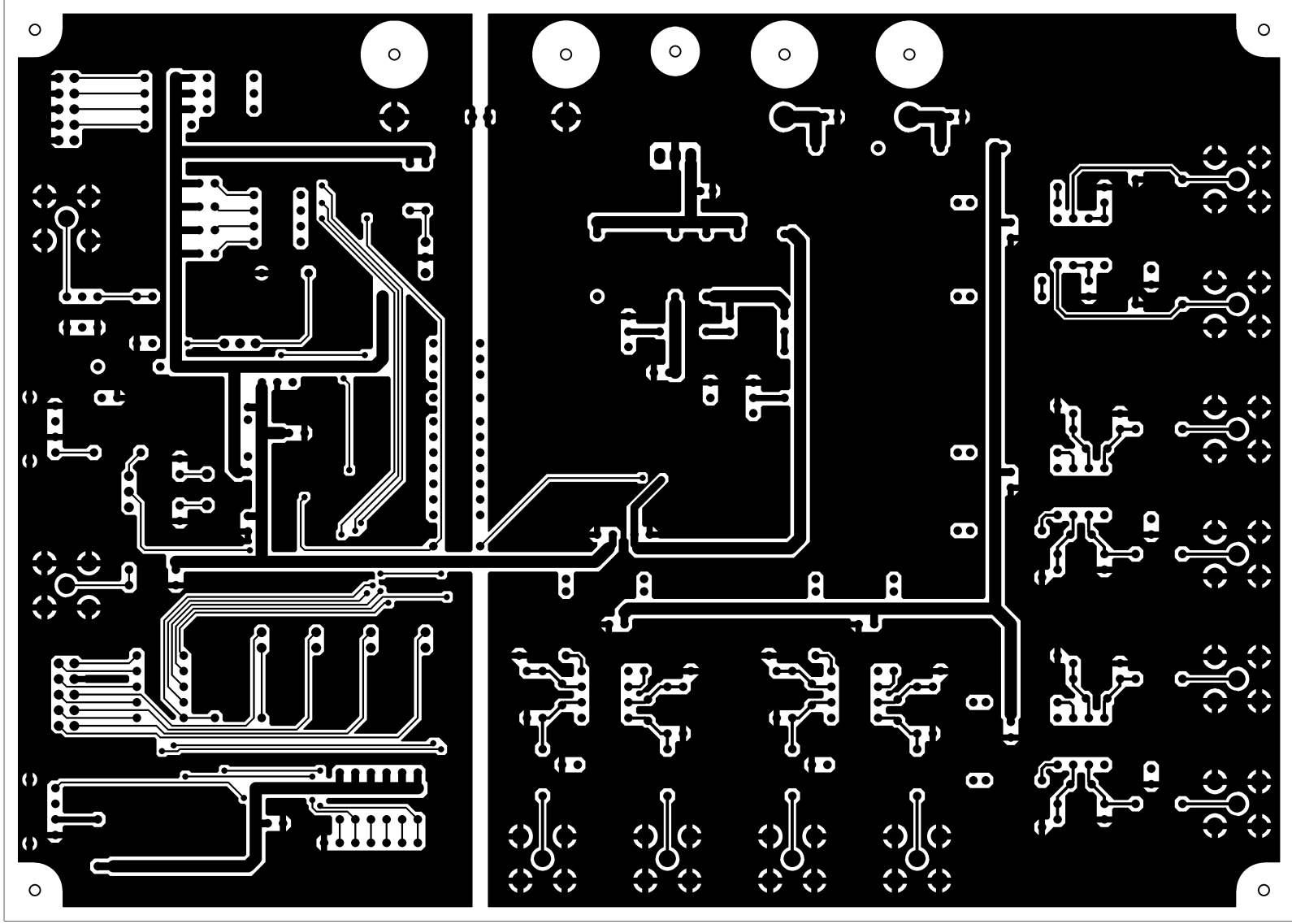

AKD4529 Rev.B LS