



AK9844

4Kbit EEPROM with 4ch 8bit D/A Converter

GENERAL DESCRIPTION

The AK9844 includes 4 channel, 8-bit D/A converters with on-chip output buffer amps and it is capable to store the input digital data of each D/A converter by on-chip non-volatile CMOS EEPROM. The AK9844 is optimally designed for various circuit adjustments for consumer and industrial equipments and it is ideally suited for replacing mechanical trimmers.

FEATURES

- EEPROM SECTION
 - 4 word × 8-bit organization (Dedicated for DAC data)
 - 256 word × 16-bit organization (General purpose memory)
 - Serial data interface
 - Sequential register read
 - Automatic write cycle
 - 100K write cycles
 - 10 year data retention

- D/A SECTION
 - 4 channels
 - Resolution : 8-bits
 - Differential Non-Linearity : ± 1.0 LSB
 - Linearity Error : ± 2.0 LSB
 - Output Voltage Range : GND ~ VCC

- AUTO READ Function
- Power down mode

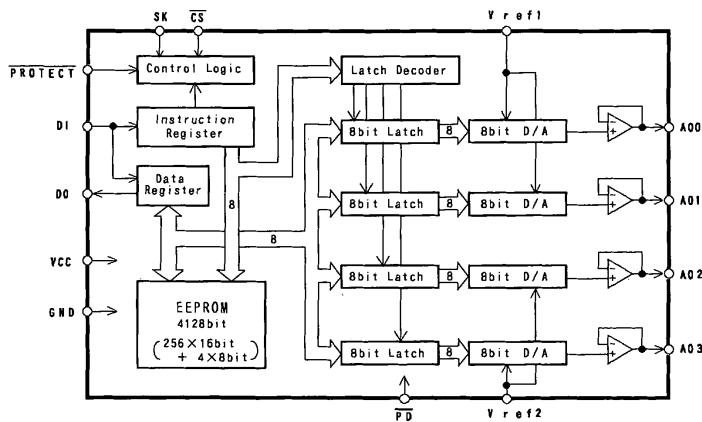

Block Diagram

■ Ordering Guide

AK9844F

-20 to 70°C

14-pin SOP (1.27mm pitch)

■ Pin Layout

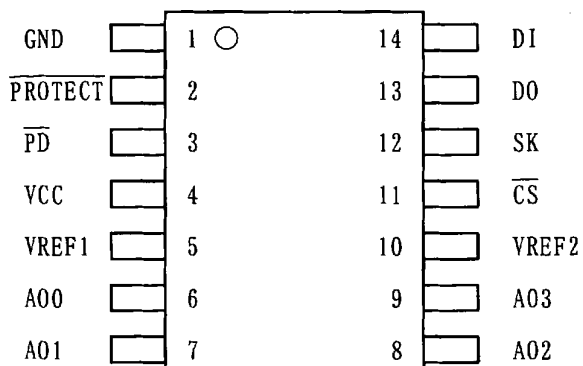

■ Pin Description

No.	Pin Name	I/O	Function
1	GND	-	Ground Pin, 0V
2	PROTECT	I	Protect Pin "L" : Programming to the D/A Section of EEPROM is disabled. "H" : Normal operation
3	PD	I	Power-down Pin "L" : Power down mode "H" : Normal mode
4	VCC	-	Power Supply
5	VREF1	I	Voltage Reference Input1 The analog output ranges of the AO0 and the AO1 are set by the VREF1 pin.
6	AO0	O	Analog Output Pins (8-bit D/A outputs)
7	AO1		
8	AO2		
	AO3		
10	VREF2	I	Voltage Reference Input2 The analog output ranges of the AO2 and the AO3 are set by the VREF2 pin.
11	CS	I	Chip Select Pin (Schmitt-trigger input)
12	SK	I	Serial Clock Pin (Schmitt-trigger input)
13	DO	O	Serial Data Input Pin
14	DI	I	Serial Data Output Pin

Functional Description

The AK9844 includes the EEPROM section and the D/A converter section which consists of 4 channel, 8bit D/A converters with output buffer amps. The EEPROM section is divided into memory block and DAC register block. The capacity of the memory block is 4096bits which are organized into 256 registers of 16bits each. The DAC digital input data for D/A converters are stored in the DAC register block which is organized into 4 registers of 8bits each. The address for the memory block is "000000000" to "011111111". The address for the DAC register is "100000000" to "100000011".

The configuration of the EEPROM section is showed on figure.1.

The AK9844 can connect to the serial communication port of popular one chip microcontrollers directly (3 line negative clock synchronous interface). At write operation, the AK9844 takes in the write data from the DI pin to a register synchronously with rising edge of the SK pin. At read operation, the AK9844 takes out the read data from a register to the DO pin synchronously with falling edge of the SK pin.

The AK9844 has 6 instructions such as READ, WRITE, WREN, WRDS, PDEN and PDDS. The each instruction is organized by op-code block(8bits), address block(8bits), and data(8bits×2).The output of DAC is set by storing the DAC digital input data in the DAC register block.

The DO pin is high impedance except that the DO pin outputs the read data and the status signal.

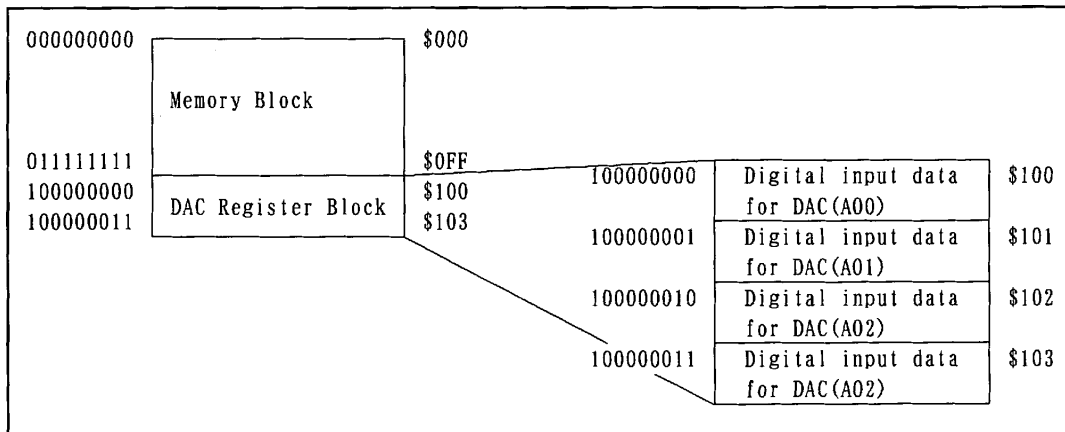

Figure.1 Configuration of the EEPROM section

■ **Data Protection**

To protect against accidental data disturb, the AK9844 has programming enable state and programming disable state. In programming disable state, the programming operation is not executed.

When Vcc is applied to the AK9844, the AK9844 is powered up in the programming disable mode. The programming instruction should be preceded by the WREN instruction. Once the WREN instruction is executed, the programming state remains enabled until the WRDS instruction is executed or VCC is removed from the device. Execution of the READ instruction is independent of both WREN and WRDS instructions.

The AK9844 also can prohibit to program into the DAC register block by the control of the $\overline{\text{PROTECT}}$ pin. When the $\overline{\text{PROTECT}}$ pin is "L", the programming into the DAC register block is not executed.

$\overline{\text{PROTECT}}$ pin	$\overline{\text{PROTECT}} = \text{"H"}$		$\overline{\text{PROTECT}} = \text{"L"}$	
	Enable	Disable	Enable	Disable
Memory Block	○	×	○	×
DAC Register Block	○	×	×	×

○ :Programming into the block is executed.

× :Programming into the block is not executed.

Table.1 Relation between the programming operation and the $\overline{\text{PROTECT}}$ pin

■ **Output of D/A converter**

The AK9844 includes 4 channel, 8bit D/A converter. The output voltage ranges for AO0 and AO1 are set by the VREF1 pin and the output voltage ranges for AO2 and AO3 are set by the VREF2 pin.

The output voltage can be set by the READ or WRITE instruction.

When the DAC register block is specified in the WRITE instruction, the output voltage for the specified D/A converter is set. When the WRITE instruction is executed in case that the PROTECT pin is "H" and the programming state is enabled, the output voltage for the specified D/A converter is set and the specified address in the DAC register block in EEPROM is written with the data specified in the instruction.

When the WRITE instruction is executed in case that the $\overline{\text{PROTECT}}$ pin is "H" and the programming state is disabled, the output voltage for the specified D/A converter is set and the specified address in the DAC register block in EEPROM is not written with the data specified in the instruction. When the WRITE instruction is executed in case that the $\overline{\text{PROTECT}}$ pin is "L", the output voltage for the specified D/A converter is not set and the specified address in the DAC register block in EEPROM is not written with the data specified in the instruction. The relation between the WRITE instruction and the DAC register block is showed on the table.2.

When the DAC register block is specified in the READ instruction, the output voltage for the specified D/A converter is set by the data which is stored in the DAC register block in EEPROM, and the DO pin outputs the data in the specified address.

Execution of the READ instruction is independent of the $\overline{\text{PROTECT}}$ pin and the programming state.

PROTECT pin	Programming State	DAC register block (EEPROM Section)	Output of DAC (D/A Converter Section)
"H"	Enable	The specified address in the DAC register block is written with the data specified in the instruction.	The output voltage for the specified D/A converter is set by the data specified in the instruction.
	Disable		
"L"	Enable	The data in the DAC register section does not change.	The output of the DAC does not change.
	Disable		

Table.2 Relation between the WRITE instruction and the DAC register block

○ **AUTO READ Function**

When Vcc is applied to the AK9844, the data on EEPROM are read out and loaded at a time to each corresponding D/A (4 channels total) automatically, starting from AO0 to AO3 in ascending order. Then each D/A analog output is settled to pre-determined value.

If the $\overline{\text{CS}}$ pin goes to "H" and then goes to "L" after "power-up" with the $\overline{\text{PROTECT}}$ pin and the $\overline{\text{CS}}$ pin left "L", AUTO READ cycle is initiated. After the $\overline{\text{CS}}$ pin goes to "L", 4 channel D/A outputs are settled to pre-determined value within 2ms.

In AUTO READ cycle, the SK pin and the DI pin become "don't care" and the serial data do not output.

If the WREN instruction is executed after AUTO READ cycle is completed, programming into the memory block on the internal EEPROM is enabled.

■ Instruction and Data Format

The instructions consist of op-code(8bits), address(8bits) and data(8bits×2). The followings are the instruction and data set at WRITE execution.

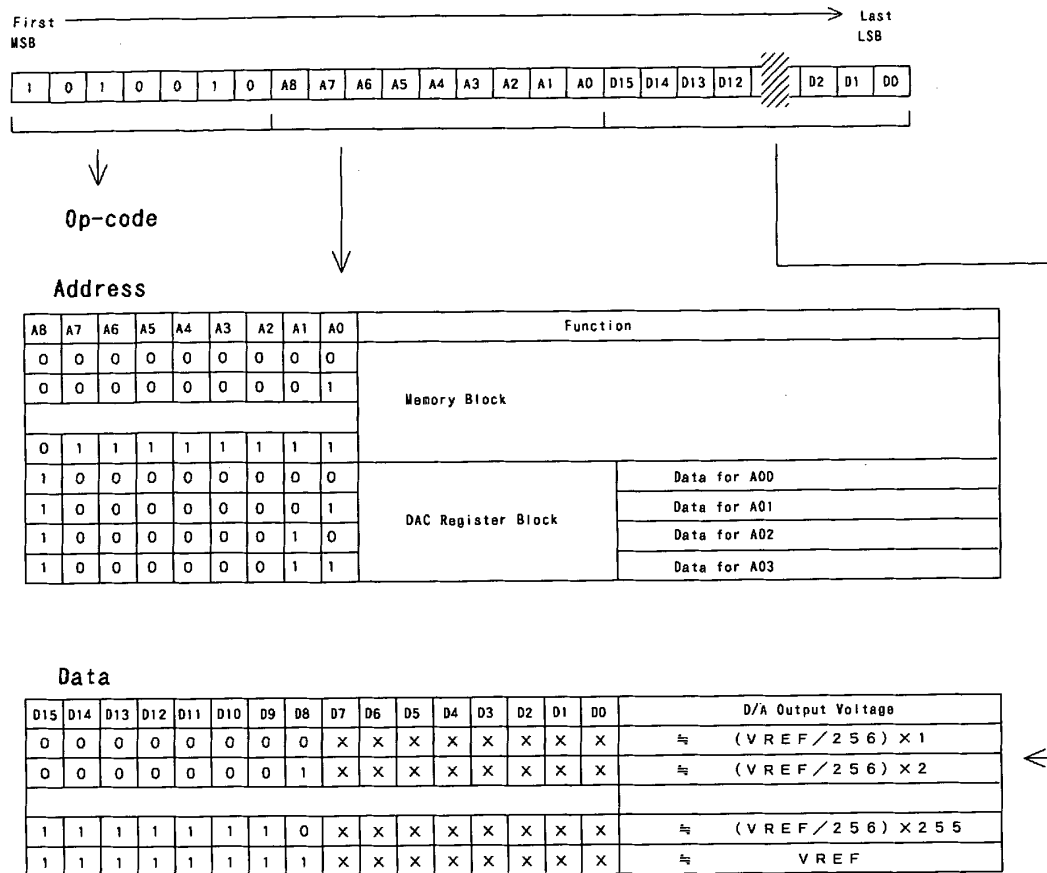

■ **Power Down Function**

There are the power down mode and the normal mode in AK9844. When the AK9844 is in power down mode, the outputs of D/A are "High impedance" and the DAC section is in the standby mode and the power consumption of the AK9844 is decreased.

The power down mode of AK9844 can be determined by the control of the \overline{PD} pin or the PDEN/ PDDS instructions.

When the \overline{PD} pin is low level, the AK9844 is in power down mode. When the \overline{PD} pin is high level, the state of the AK9844 can be determined by PDEN/PDDS instructions. When the \overline{PD} pin is High level and the PDEN instruction is executed, the AK9844 becomes the power down mode. Once the AK9844 becomes the power down mode, the AK9844 is in the power down mode until the PDDS instruction is executed. When the PDDS instruction is executed, the AK9844 becomes the normal mode.

If the \overline{CS} pin is High level in the power down mode, the EEPROM section also becomes the standby mode and the AK9844 becomes the lower power-down mode.

The relation between the \overline{PD} pin and the PDEN/PDDS instructions is showed on table.3. The relation between the power down mode and the DAC/EEPROM section is showed on table.4. The state at the time AK9844 is powered up is showed on table.5.

\overline{PD} pin	instruction	mode
Low level	PDEN	power down mode
	PDDS	
High level	PDEN	power down mode
	PDDS	normal mode

Table.3 Relation between the \overline{PD} pin and the PDEN/PDDS instructions

State	DAC section	EEPROM section
normal mode	normal mode	normal mode
power down mode1 $\overline{CSpin}=L$	standby mode	normal mode
power down mode2 $\overline{CSpin}=H$	standby mode	standby mode

Table.4 Relation between the power down mode and the DAC/EEPROM section

Condition at the time AK9844 is powered on		State
$\overline{PDpin} = "L"$	$\overline{CSpin}=L$	power down mode1
	$\overline{CSpin}=H$	power down mode2
$\overline{PDpin} = "H"$		normal mode

Table.5 State at the time AK9844 is powered up

■ **Precautions for use**

- 1) Output voltage of D/A converter at the time the AK9844 is powered up
At the time the AK9844 is powered up, the D/A converters output "Vref/2" until the instruction or AUTO READ is executed.
- 2) Power Supply Decoupling
On the boards, decoupling capacitors(0.1uF) between power supply pins(VCC,VREF1,VREF2) and GND should be located as near as possible to the part.

Instruction Set

The AK9844 has 6 instructions such as READ, WRITE, WREN, WRDS, PDEN, PDDS. Each instruction consists of Op-code, address and data. The instruction set is showed on table.6.

When the instructions are executed consecutively, the \overline{CS} pin should be brought to high level for a minimum of 1us(tCS) between consecutive instruction cycle.

Instruction	Op-code	Address	Data	Comments
READ	1 0 1 0 1 0 0	A8 A7 A6 A5 A4 A3 A2 A1 A0	D15~D0	Read register
WRITE	1 0 1 0 0 1 0	A8 A7 A6 A5 A4 A3 A2 A1 A0	D15~D0	Write register
WREN	1 0 1 0 0 0 1	* * * * *	*~	Write enable
WRDS	1 0 1 0 0 0 0	* * * * *	*~	Write Disable
PDEN	1 0 1 0 1 1 0	* * * * *	*~	Power down enable
PDDS	1 0 1 0 0 1 1	* * * * *	*~	Power down desable

*: Don't Care

Table.6 Instruction set

■ **WRITE**

The WRITE instruction is followed by 16 bits of data to be written into the specified address. After the 32nd rising edge of SK to read DO in, the AK9844 will be put into the automatic write time-out period. During the automatic write time-out period (\overline{Busy} status), the \overline{CS} pin need not be high level.

The DO pin indicates the Ready/ \overline{Busy} status of the EEPROM in AK9844. After the 32nd rising edge of SK to read DO in, the AK9844 will be put into the automatic write time-out period.

When the automatic write time-out period start, the DO pin outputs the Ready/ \overline{Busy} status.

When the DO pin outputs low level, the AK9844 is in the automatic write time-out and the next instruction can not be accepted. When the DO pin outputs high level, the automatic write time-out period has ended and the AK9844 is ready for a next instruction.

When the CS pin is changed to high level after confirmation of Ready/ \overline{Busy} signal on the DO pin, the DO pin becomes "Hi-Z". The Ready/ \overline{Busy} signal can be confirmed until the initial 1 bit of the next instruction inputs from the execution of the WRITE instruction.

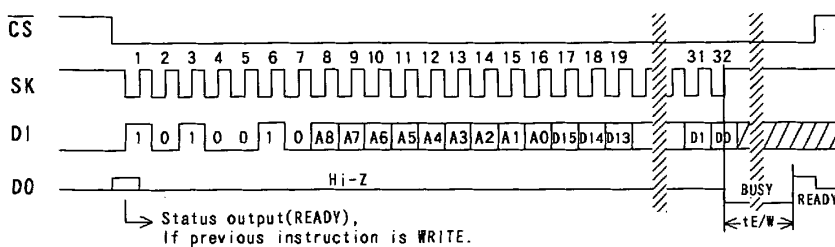

WRITE instruction

■ READ

The read instruction is the only instruction which outputs serial data on the DO pin. After a read instruction is received, the instruction and address are decoded, followed by data transfer from the memory register into a 16 bit serial-out shift register. When the 17th falling edge of SK is received, the Do pin will come out of high impedance state and shift out the data from D15 first in descending order which is located at the address specified in the instruction.

○ Sequential register read

The data in the next address can be read sequentially to provide clock. The memory automatically cycles to the next register after each 16 data bits are clocked out.

The sequential register read function is effective for address:A7~A0. When the highest address is reached(\$0FF/\$103), the address counter rolls over to address \$000/\$100 allowing the read cycle to be continued indefinitely.

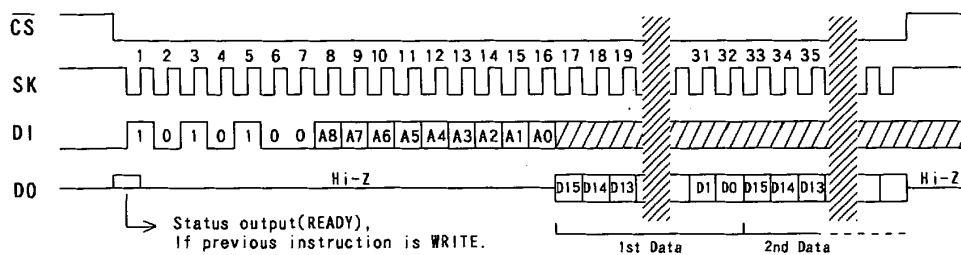

READ instruction

■ WREN/WRDS

When Vcc is applied to the part, it powers up in the programming disable(WRDS) state. Programming must be preceded by a programming enable(WREN) instruction. Programming remains enabled until a programming disable(WRDS) instruction is executed or Vcc is removed from the part. The programming disable instruction is provided to protect against accidental data disturb. Execution of a read instruction is not affected by both WREN and WRDS instruction.

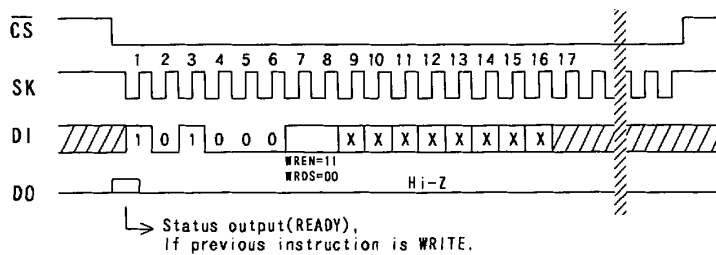

WREN/WRDS instruction

■ PDEN/PDDS

The AK9844 has the power-down mode and the normal mode. When the PDEN instruction is executed while the \overline{PD} pin is high level, the AK9844 becomes the power-down mode. The AK9844 is in the power-down mode until PDDS instruction is executed. After the PDDS instruction is executed, the AK9844 changed to normal mode from power-down mode.

In case that the PD pin is low level, the PDEN/PDDS instructions are invalid and are not executed.

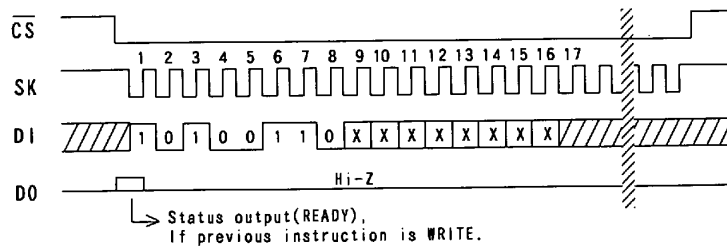
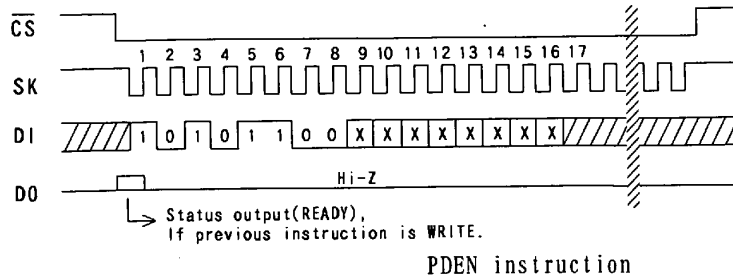

ABSOLUTE MAXIMUM RATINGS

Parameter	Symbol	Condition	Spec.	Unit
DC Power Supplies	VCC	relative to GND	-0.3~+6.5	V
Input Voltage	VIO	relative to GND	-0.3~VCC+0.3	V
Ambient Temperature (power applied)	Ta		-20~+70	°C
Storage Temperature	TST		-65~+150	°C

RECOMMENDED OPERATING CONDITIONS

Parameter	Symbol	Condition	min	typ	max	Unit
Power supplies	VCC1	DAC operation	4.5		5.5	V
	VCC2	EEPROM operation	2.2		5.5	V
Analog Output Load Load Capacitance	AOC				100	pF

ELECTRICAL CHARACTERISTICS

■ DC Characteristics

(VCC=+2.2V~5.5V, GND=0V, Ta=-20~70°C unless otherwise specified)

Parameter	Symbol	Condition	min	typ	max	Unit
Power Consumption	IDD1	Normal mode WRITE,1/tSKP=1MHz		8.0	10.0	mA
	IDD2	Normal mode READ,1/tSKP=1MHz		3.0	6.0	mA
	IDD3	Power down mode1 READ,1/tSKP=1MHz			1.0	mA
	IDD4	Power down mode2			10.0	uA
Note1.,Note2.,Note3.						
Input High Voltage $\overline{\text{CS}}$,SK, $\overline{\text{PROTECT}}$ pin $\overline{\text{PD}}$,DIpin	VIH		80%VCC 70%VCC			V V
Input Low Voltage $\overline{\text{CS}}$,SK, $\overline{\text{PROTECT}}$ pin $\overline{\text{PD}}$,DIpin	VIL				20%VCC 30%VCC	V V
Output High Voltage	VOH	IOH=-50uA	VCC-0.3			V
Output Low Voltage	VOL	IOL=1.0mA			0.4	V
Input Leakage Current	ILI	VIN=VCC			10.0	uA
3 State Leakage Current	IOZ	$\overline{\text{CS}}$ ="H"			±10.0	uA

Note1. All input pins are connected to either Vcc or GND.

Note2. DO=OPEN

Note3. Please refer to "Power Down Function" regarding power down mode.

■ AC Characteristics

1)EEPROM section

(VCC=+2.2V~5.5V, GND=0V, Ta=-20~70°C unless otherwise specified)

Parameter	Symbol	Condition	min	typ	max	Unit
SK cycle1	tSKP1	(Note4)	1.0			us
SK pulse width1	"L"	tSWL1	400			ns
	"H"	tSWH1	(Note4)	400		ns
SK cycle2	tSKP2	(Note5)	4.0			us
SK pulse width2	"L"	tSWL2	1			us
	"H"	tSWH2	(Note5)	1		us
$\overline{\text{CS}}$ Setup Time	tCSS		100			ns
$\overline{\text{CS}}$ Hold Time	tCSH	(Note6)	100			ns
SK Setup time	tSKS		100			ns
Data Setup Time	tDIS		200			ns
Data Hold Time	tDIH		200			ns
Data Output Delay	tPD	C _L =100pF			300	ns
Self-timed Program Time	tE/W				15	ms
Write Recovery Time	tRC		100			ns
Min $\overline{\text{CS}}$ High Time	tCS		1.0			us
Do High-Z Time	tOZ				500	ns

Note4. $4.5\text{V} \leq \text{VCC} \leq 5.5\text{V}$

Note5. $2.2\text{V} \leq \text{VCC} < 4.5\text{V}$

Note6. In case that the data of the DAC section is not changed and the output of the DAC is changed, tCSH is min.1us.

2) DAC section

(VCC=+5V±10%, GND=0V, Ta=-20~70°C unless otherwise specified)

Parameter	Symbol	Condition	min	typ	max	Unit
D/A Reference Voltage						
A0,A1	VREF1		3.5		VCC	V
A2,A3	VREF2		3.5		VCC	V
D/A Reference current	IREF	VREF=5.0V		200		uA
Resolution		Monotonicity			8	bit
Differential Non-Linearity	DNL	VCC=VREF=5.0V	-1	0	+1	LSB
Integral Non-Linearity (Note8)	NL	1LSB=VREF/256	-2.0	0	+2.0	LSB
Error or Input data "00" (Note7)	EZERO	IAO=0.0uA			+0.1	V
Error for Input data "FF" (Note7)	EFULL	CL=100pF			+0.1	V
Buffer-AMP Output Voltage Range	VAO	IAO ≤200uA	0.2		VCC-0.2	V
Buffer-AMP Output Voltage Range	VAO	IAO ≤500uA	0.3		VCC-0.3	V
Setup Time in AUTO READ	tARS		500			us
D/A Settling Time	tLDD	CL=100pF		100		us

Note7. Please refer to the figure.2.

Note8. Integral Non-Linearity is the error between the actual line and the ideal line. The ideal line exhibits a perfect linear DAC output characteristics between the input digital data "00" and the input digital data "FF".

* Please refer to "Instruction and Data Format" regarding the relation between input digital data and DAC output voltage.

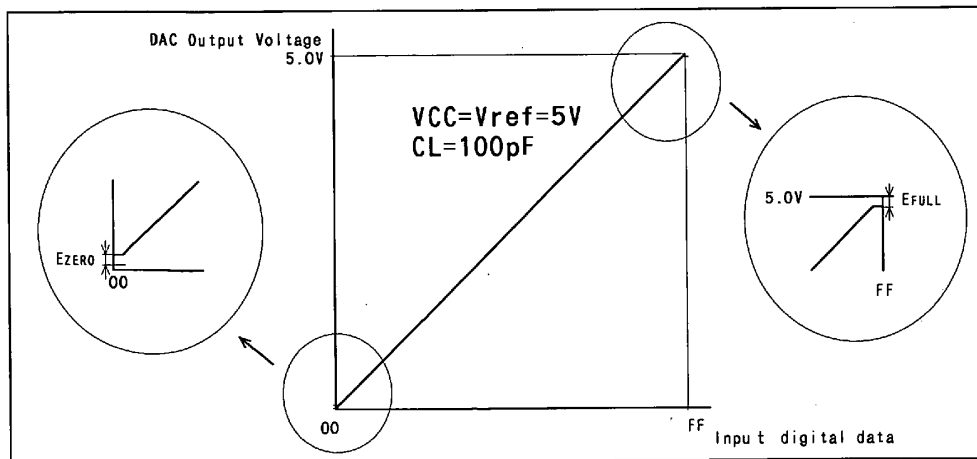
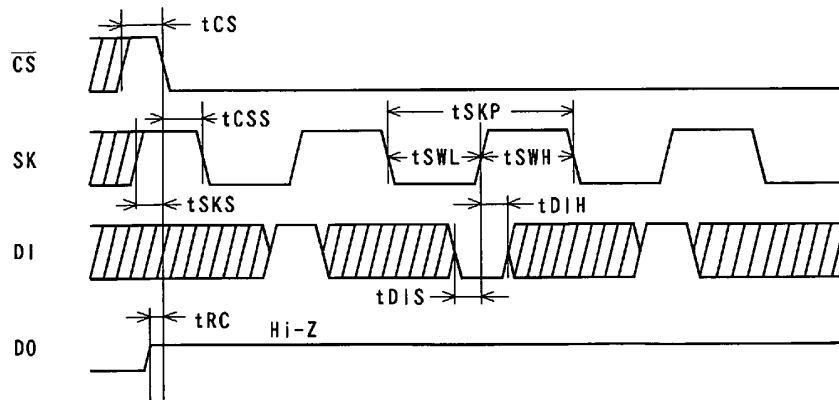
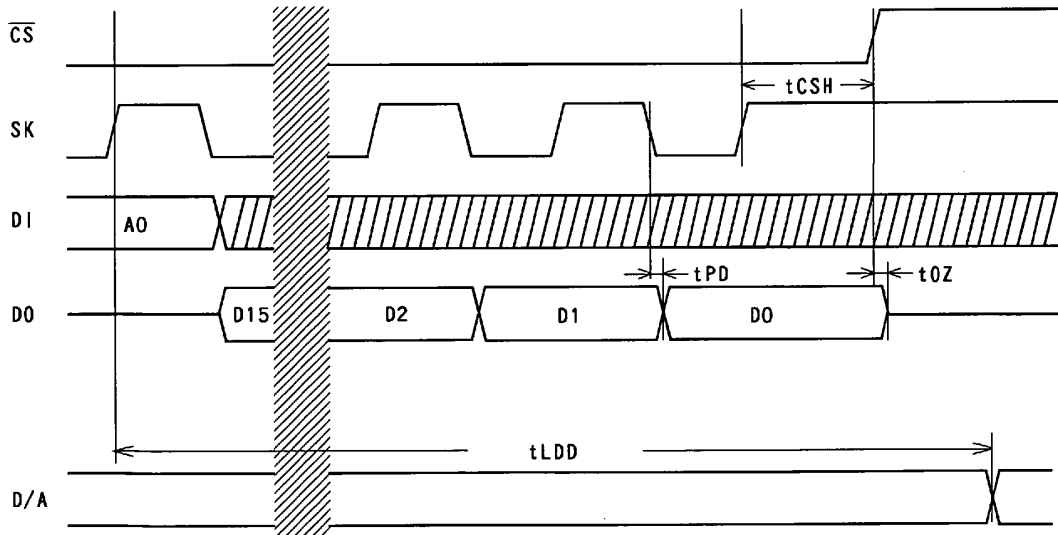

Figure.2 DAC output characteristics(IAO=0.0uA)

■ Timing waveform



Input Waveform



Waveform in READ instruction

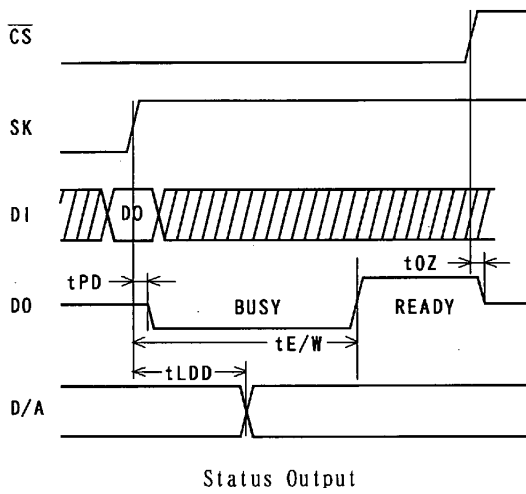
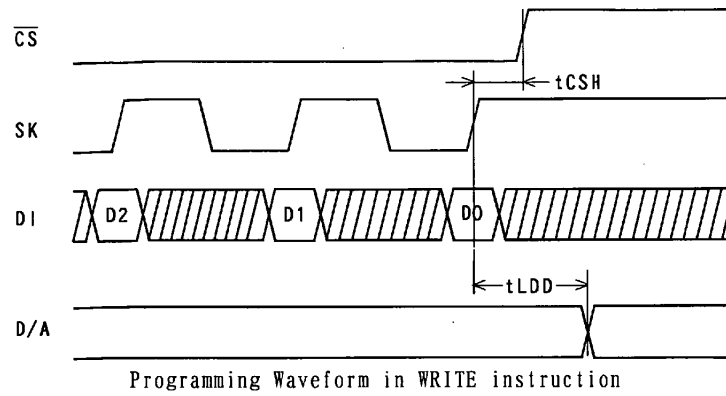

(Note) In case that the data of the DAC section is not changed and the output of the DAC is changed, Ready/Busy signal does not output on DO pin.

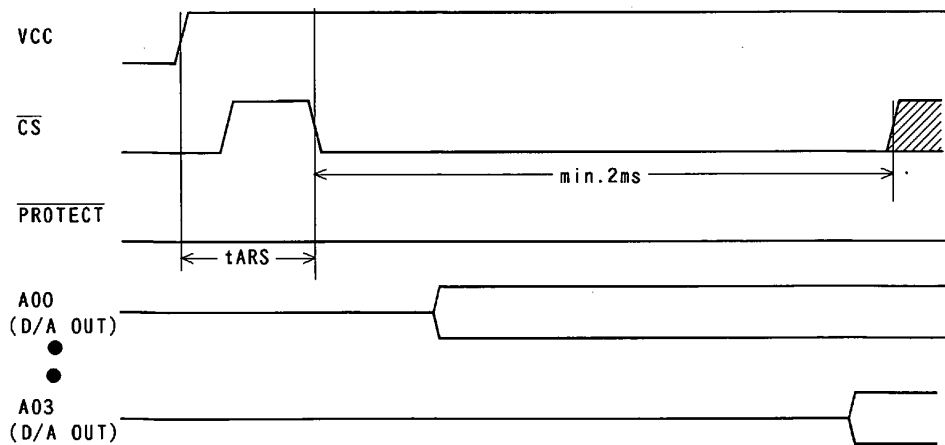

Waveform in AUTO READ

IMPORTANT NOTICE

- These products and their specifications are subject to change without notice. Before considering any use or application, consult the Asahi Kasei Microsystems Co., Ltd. (AKM) sales office or authorized distributor concerning their current status.
- AKM assumes no liability for infringement of any patent, intellectual property, or other right in the application or use of any information contained herein.
- Any export of these products, or devices or systems containing them, may require an export license or other official approval under the law and regulations of the country of export pertaining to customs and tariffs, currency exchange, or strategic materials.
- AKM products are neither intended nor authorized for use as critical components in any safety, life support, or other hazard related device or system, and AKM assumes no responsibility relating to any such use, except with the express written consent of the Representative Director of AKM. As used here:
 - (a) A hazard related device or system is one designed or intended for life support or maintenance of safety or for applications in medicine, aerospace, nuclear energy, or other fields, in which its failure to function or perform may reasonably be expected to result in loss of life or in significant injury or damage to person or property.
 - (b) A critical component is one whose failure to function or perform may reasonably be expected to result, whether directly or indirectly, in the loss of the safety or effectiveness of the device or system containing it, and which must therefore meet very high standards of performance and reliability.
- It is the responsibility of the buyer or distributor of an AKM product who distributes, disposes of, or otherwise places the product with a third party to notify that party in advance of the above content and conditions, and the buyer or distributor agrees to assume any and all responsibility and liability for and hold AKM harmless from any and all claims arising from the use of said product in the absence of such notification.