

General Description

The AAT4611 SmartSwitch is a current limited P-channel MOSFET power switch designed for high-side load switching applications. This switch operates with inputs ranging from 2.7V to 5.5V, making it ideal for both 3V and 5V systems. An integrated current-limiting circuit protects the input supply against large currents which may cause the supply to fall out of regulation. The AAT4611 is also protected from thermal overload which limits power dissipation and junction temperatures. It can be used to control loads that require up to 1A. Current limit threshold is programmed with a resistor from SET to ground. The quiescent supply current is typically a low 15µA max. In shutdown mode, the supply current decreases to less than 1µA.

The AAT4611 is available in a Pb-free 5-pin SOT23 package and is specified over the -40°C to +85°C temperature range.

Features

- Input Voltage Range: 2.7V to 5.5V
- Programmable Over-Current Threshold
- Fast Transient Response:
 - <math><1\mu\text{s}</math> Response to Short Circuit
- Low Quiescent Current
 - 15µA Typical
 - 1µA Max with Switch Off
- 160mΩ Typical $R_{DS(ON)}$
- Only 2.5V Needed for ON/OFF Control
- Under-Voltage Lockout
- Thermal Shutdown
- 4kV ESD Rating
- 5-Pin SOT23 Package
- Temperature Range: -40°C to +85°C

Applications

- Hot Swap Supplies
- Notebook Computers
- Peripheral Ports
- Personal Communication Devices

Typical Application

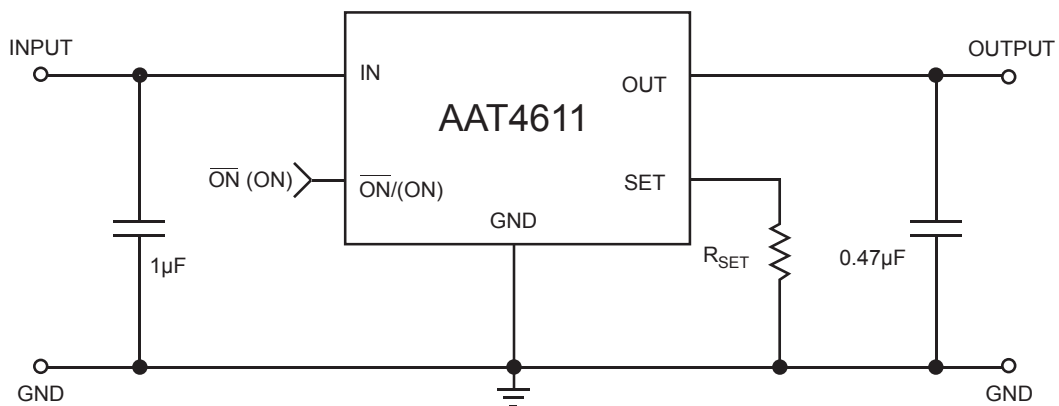

Pin Descriptions

Pin #	Symbol	Function
1	OUT	P-channel MOSFET drain. Connect a 0.47 μ F capacitor from OUT to GND.
2	GND	Ground connection.
3	SET	Current limit set input. A resistor from SET to ground sets the current limit for the switch.
4	$\overline{\text{ON}}$	Enable input. Two versions are available, active-high and active-low. See Ordering Information for details.
5	IN	P-channel MOSFET source. Connect a 1 μ F capacitor from IN to GND.

Pin Configuration

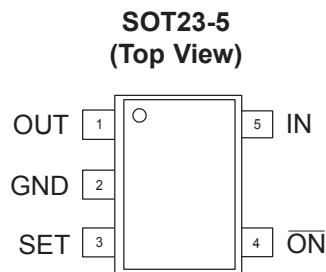

Absolute Maximum Ratings¹

$T_A = 25^\circ\text{C}$, unless otherwise noted.

Symbol	Description	Value	Units
V_{IN}	IN to GND	-0.3 to 6	V
V_{ON}	\overline{ON} (ON) to GND	-0.3 to $V_{IN} + 0.3$	V
V_{SET}, V_{OUT}	SET, OUT to GND	-0.3 to $V_{IN} + 0.3$	V
I_{MAX}	Maximum Continuous Switch Current	2	A
T_J	Operating Junction Temperature Range	-40 to 150	$^\circ\text{C}$
T_{LEAD}	Maximum Soldering Temperature (at leads)	300	$^\circ\text{C}$
V_{ESD}	ESD Rating ² - HBM	4000	V

Thermal Characteristics³

Symbol	Description	Value	Units
Θ_{JA}	Thermal Resistance	150	$^\circ\text{C}/\text{W}$
P_D	Power Dissipation	667	mW

1. Stresses above those listed in Absolute Maximum Ratings may cause permanent damage to the device. Functional operation at conditions other than the operating conditions specified is not implied. Only one Absolute Maximum Rating should be applied at any one time.
2. Human body model is a 100pF capacitor discharged through a 1.5k Ω resistor into each pin.
3. Mounted on a demo board.

Electrical Characteristics

$V_{IN} = 5V$, $T_A = -40^{\circ}C$ to $+85^{\circ}C$, unless otherwise noted. Typical values are $T_A = 25^{\circ}C$.

Symbol	Description	Conditions	Min	Typ	Max	Units
V_{IN}	Operation Voltage		2.7		5.5	V
I_Q	Quiescent Current	$V_{IN} = 5V$, ON (\overline{ON}) = Active, $I_{OUT} = 0$		15	30	μA
$I_{Q(OFF)}$	Off-Supply Current	ON (\overline{ON}) = Inactive, $V_{IN} = 5.5V$			1	μA
$I_{SD(OFF)}$	Off-Switch Current	ON (\overline{ON}) = Inactive, $V_{IN} = 5.5V$, $V_{OUT} = 0$		0.03	15	μA
V_{UVLO}	Under-Voltage Lockout	Rising Edge, 1% Hysteresis	2.0	2.3	2.7	V
$R_{DS(ON)}$	On Resistance	$V_{IN} = 5.0V$		160	180	m Ω
		$V_{IN} = 4.5V$		165		
		$V_{IN} = 3.0V$		195	230	
I_{LIM}	Current Limit	$R_{SET} = 6.8k\Omega$	0.75	1	1.25	A
$I_{LIM(MIN)}$	Minimum Current Limit			130	195	mA
$V_{ON(L)}$	ON (\overline{ON}) Input Low Voltage				0.8	V
$V_{ON(H)}$	ON (\overline{ON}) Input High Voltage	$V_{IN} = 2.7V$ to $3.6V$	2.0			V
		$V_{IN} = 4.5V$ to $5.5V$	2.4			
$I_{ON(SINK)}$	ON (\overline{ON}) Input Leakage	$V_{ON} = 5.5V$		0.01	1	μA
T_{RESP}	Current Limit Response Time	$V_{IN} = 5V$		0.8		μs
T_{OFF}	Turn-Off Time	$V_{IN} = 5V$, $R_L = 10\Omega$		0.4	2	μs
T_{ON}	Turn-On Time	$V_{IN} = 5V$, $R_L = 10\Omega$		40	200	μs

Typical Characteristics

Unless otherwise noted, $V_{IN} = 5V$, $T_A = 25^\circ C$.

Quiescent Current vs. Temperature

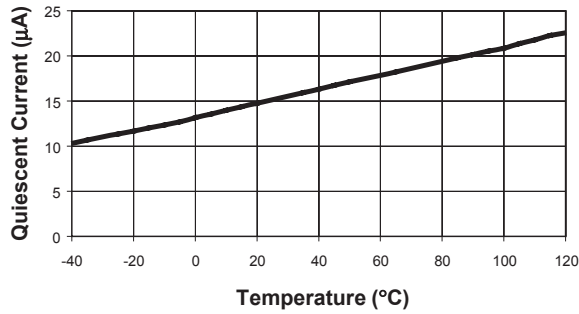

Quiescent Current

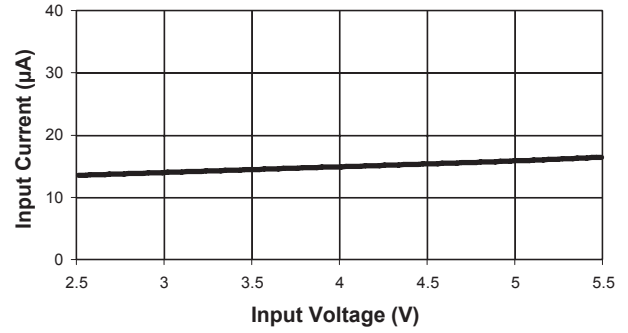

Output Current vs. Output Voltage
($R_{SET} = 16k\Omega$)

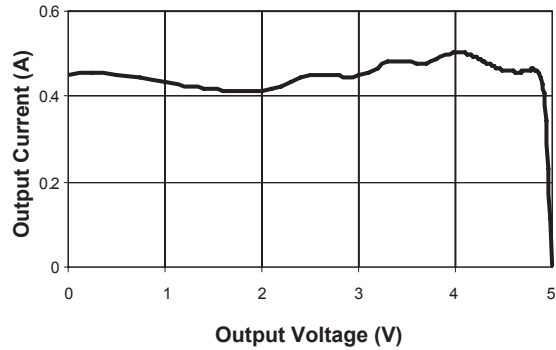

$R_{DS(ON)}$ vs. Temperature

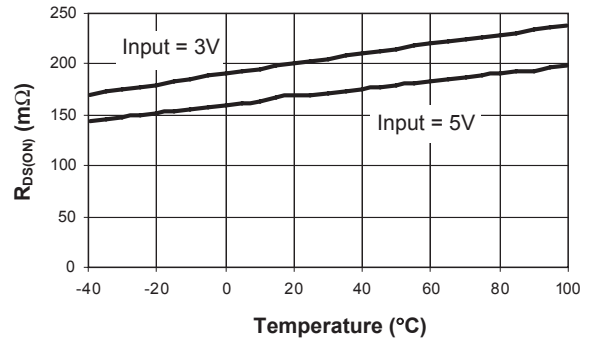

Off-Supply Current vs. Temperature

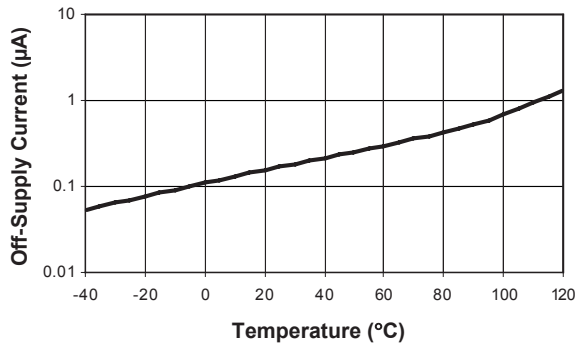

Off-Switch Current vs. Temperature

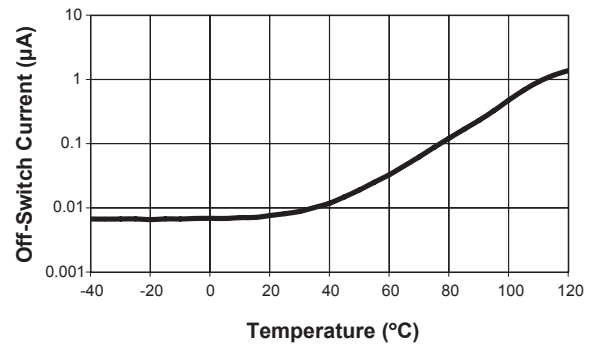

Typical Characteristics

Unless otherwise noted, $V_{IN} = 5V$, $T_A = 25^\circ C$.

Turn-On vs. Temperature

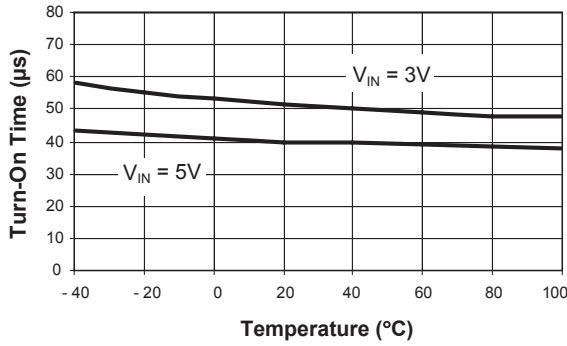

Turn-Off vs. Temperature

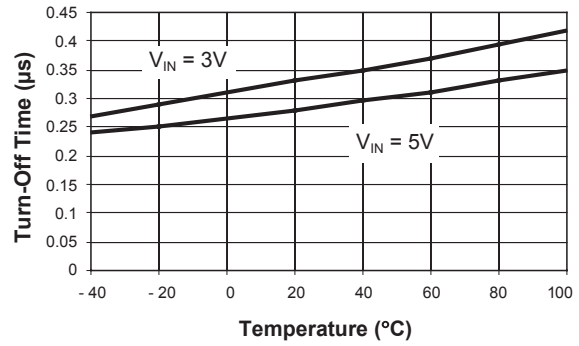

Turn-On
($R_L = 10\Omega$; $C_L = 0.47\mu F$; $I_{OUT} = I_{LIMIT}$)

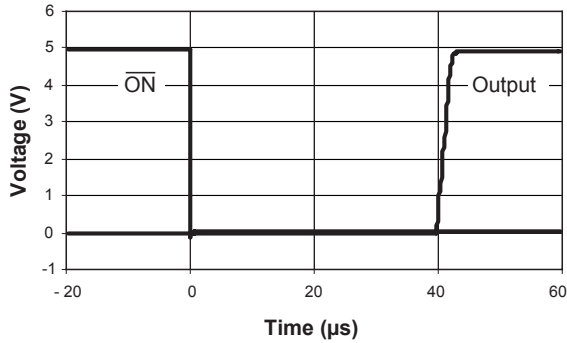

Turn-Off
($R_L = 10\Omega$; $I_{OUT} = I_{LIMIT}$)

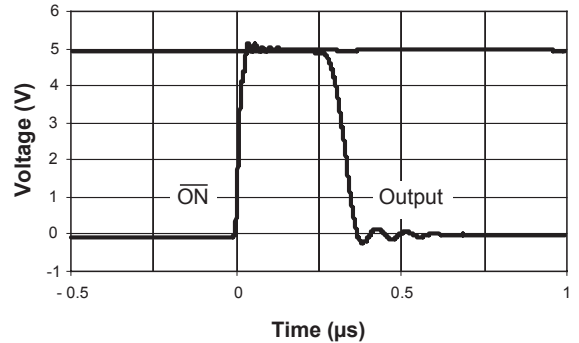

Short-Circuit Through 0.3 Ω

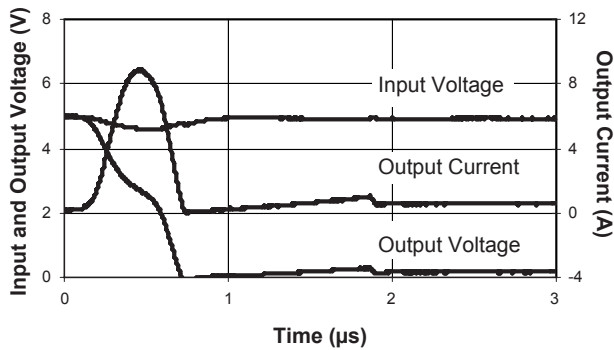

Short-Circuit Through 0.6 Ω

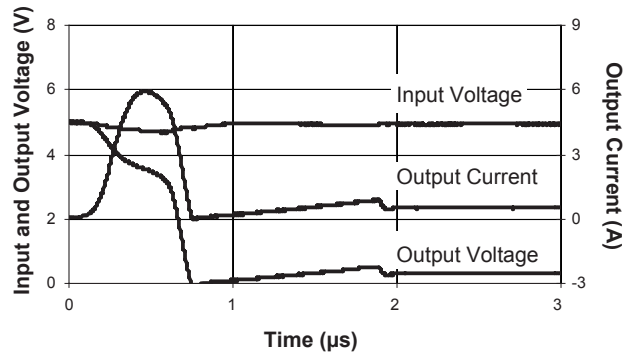

Typical Characteristics

Unless otherwise noted, $V_{IN} = 5V$, $T_A = 25^\circ C$.

R_{SET} vs. I_{LIM}

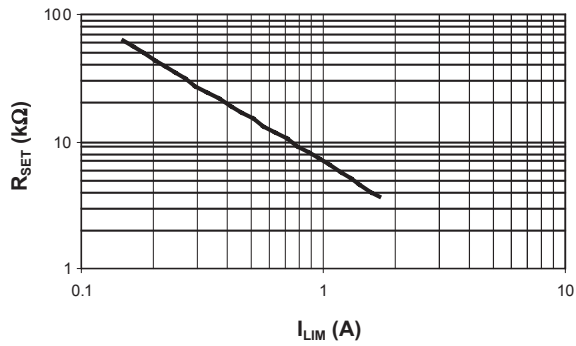

R_{SET} Coefficient vs. I_{LIM}

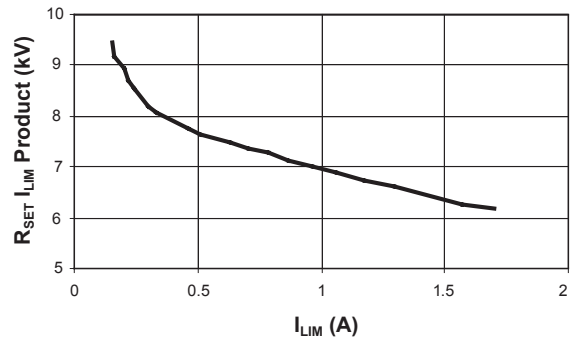

Current Limit vs. Temperature
($R_{SET} = 22.1k\Omega$; $V_{IN} - V_{OUT} = 0.5V$)

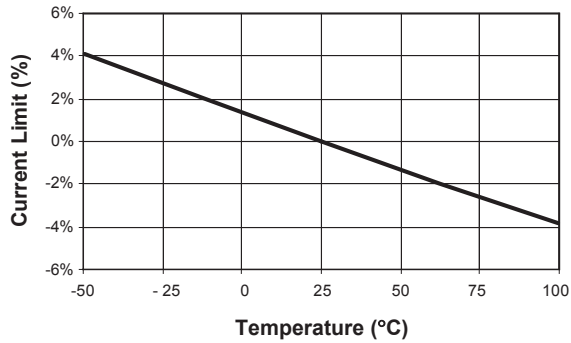

Functional Block Diagram

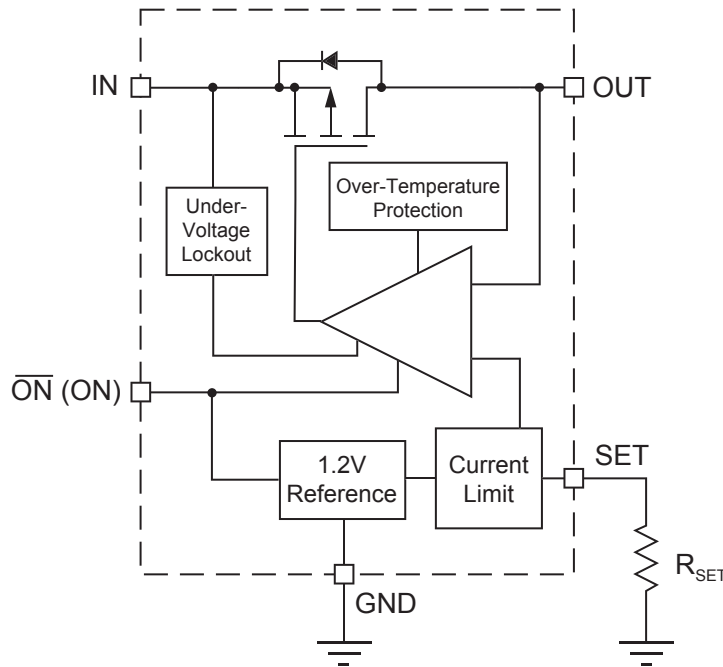

Applications Information

Setting Current Limit

In most applications, the variation in I_{LIM} must be taken into account when determining R_{SET} . The I_{LIM} variation is due to processing variations from part to part, as well as variations in the voltages at IN (Pin 5) and OUT (Pin 1) and the operating temperature. See charts "Current Limit vs. Temperature" and "Output Current vs. Output Voltage." Together, these three factors add up to a $\pm 25\%$ tolerance (see I_{LIM} specification in Electrical Characteristics section). In Figure 1, a cold device with a statistically higher current limit and a hot device with a statistically lower current limit, both with R_{SET} equal to $10.5k\Omega$, are shown. While the chart, " R_{SET} vs. I_{LIM} " indicates an I_{LIM} of $0.7A$ with an R_{SET} of $10.5k\Omega$, this figure shows that the actual current limit will be at least $0.525A$ and no greater than $0.880A$.

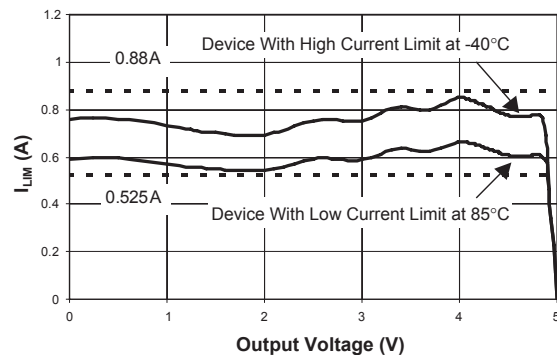

Figure 1: Current Limit Using $10.5k\Omega$.

To determine R_{SET} , start with the maximum current drawn by the load and multiply it by 1.33 (typical $I_{LIM} = \text{minimum } I_{LIM} / 0.75$). This is the typical current limit value. Next, refer to " R_{SET} vs. I_{LIM} " and find the R_{SET} that corresponds to the typical current limit value; choose the largest resistor available that is less than or equal to it. For greater precision, the value of R_{SET} may also be calculated using the I_{LIM} R_{SET} product found in the chart " R_{SET} Coefficient vs.

I_{LIM} . The maximum current is derived by multiplying the typical current for the chosen R_{SET} in the chart by 1.25. Some standard resistor values are listed in Table 1.

R_{SET} (k Ω)	Current Limit (Typ) (mA)	Device Will Not Current Limit Below (mA)	Device Always Current Limits Below (mA)
40.2	200	150	250
30.9	250	188	313
24.9	300	225	375
22.1	350	263	438
19.6	400	300	500
17.8	450	338	563
16.2	500	375	625
14.7	550	413	688
13.0	600	450	750
10.5	700	525	875
8.87	800	600	1000
7.50	900	675	1125
6.81	1000	750	1250
6.04	1100	825	1375
5.49	1200	900	1500
4.99	1300	975	1625
4.64	1400	1050	1750

Table 1: Current Limit R_{SET} Values.

Example: A USB port requires 0.5A. 0.5A multiplied by 1.33 is 0.665A. From the chart " R_{SET} vs. I_{LIM} ," R_{SET} should be less than 11k Ω . 10.5 k Ω is a standard value that is slightly less than, but very close to, 11k Ω . The chart gives approximately 0.7A as a

typical I_{LIM} value for 10.5k Ω . Multiplying 0.7A by 0.75 and 1.25 shows that the AAT4611 will limit the load current to greater than 0.525A but less than 0.875A.

Operation in Current Limit

When a heavy load is applied to the output of the AAT4611, the load current is limited to the value of I_{LIM} determined by R_{SET} (see Figure 2). Since the load is demanding more current than I_{LIM} , the voltage at the output drops. This causes the AAT4611 to dissipate a larger-than-normal quantity of power, and causes the die temperature to increase. When the die temperature exceeds an over-temperature limit, the AAT4611 will shut down until it has cooled sufficiently, at which point it will start up again. The AAT4611 will continue to cycle on and off until the load is removed, power is removed, or until a logic high level is applied to ON (Pin 4).

Enable Input

In many systems, power planes are controlled by integrated circuits which run at lower voltages than the power plane itself. The enable input \overline{ON} (Pin 4) of the AAT4611 has low and high threshold voltages that accommodate this condition. The threshold voltages are compatible with 5V TTL and 2.5V to 5V CMOS.

Reverse Voltage

The AAT4611 is designed to control current flowing from IN to OUT. If a voltage is applied to OUT which is greater than the voltage on IN, large currents may flow. This could cause damage to the AAT4611.

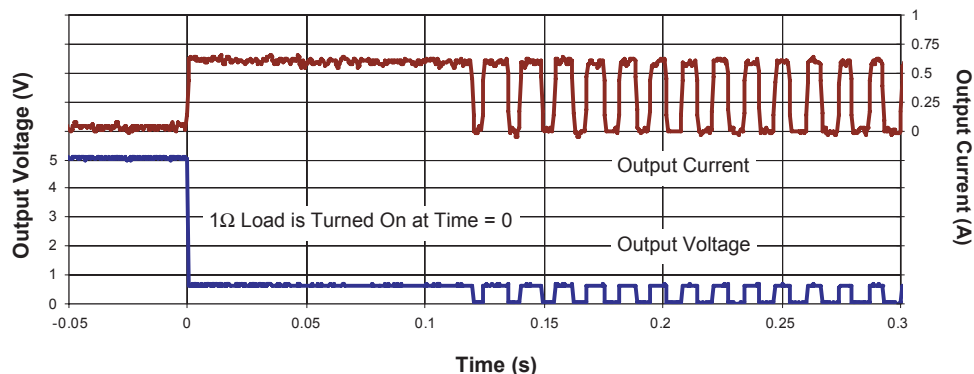

Figure 2: Overload Operation.

Ordering Information

Package	Enable	Marking ¹	Part Number (Tape and Reel) ²
SOT23-5	$\overline{\text{ON}}$ (active low)	CLXYY	AAT4611IGV-T1
SOT23-5	ON (active high)		



All AnalogicTech products are offered in Pb-free packaging. The term “Pb-free” means semiconductor products that are in compliance with current RoHS standards, including the requirement that lead not exceed 0.1% by weight in homogeneous materials. For more information, please visit our website at <http://www.analogictech.com/pbfree>.

Package Information

SOT23-5

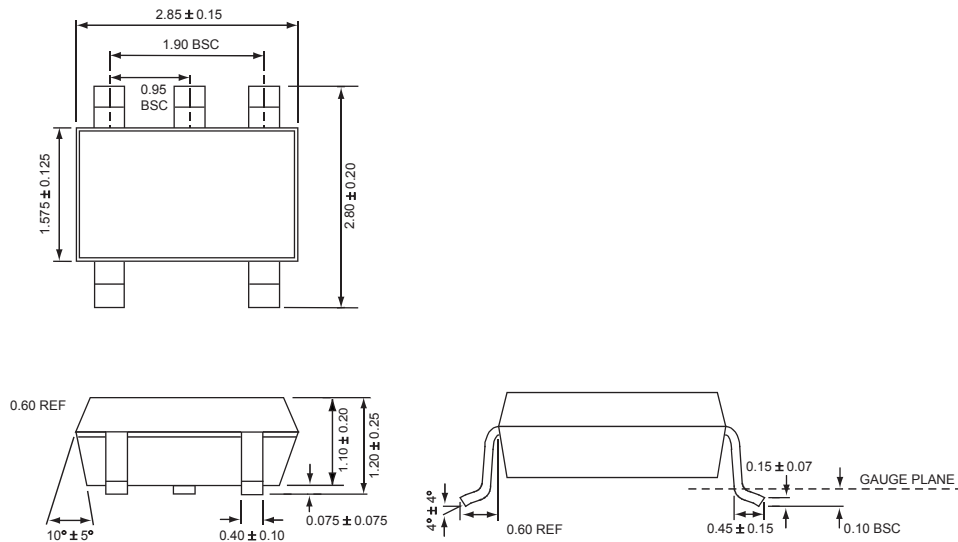

All dimensions in millimeters.

1. XYY = assembly and date code.
2. Sample stock is generally held on part numbers listed in **BOLD**.

© Advanced Analogic Technologies, Inc.

AnalogicTech cannot assume responsibility for use of any circuitry other than circuitry entirely embodied in an AnalogicTech product. No circuit patent licenses, copyrights, mask work rights, or other intellectual property rights are implied. AnalogicTech reserves the right to make changes to their products or specifications or to discontinue any product or service without notice. Customers are advised to obtain the latest version of relevant information to verify, before placing orders, that information being relied on is current and complete. All products are sold subject to the terms and conditions of sale supplied at the time of order acknowledgement, including those pertaining to warranty, patent infringement, and limitation of liability. AnalogicTech warrants performance of its semiconductor products to the specifications applicable at the time of sale in accordance with AnalogicTech's standard warranty. Testing and other quality control techniques are utilized to the extent AnalogicTech deems necessary to support this warranty. Specific testing of all parameters of each device is not necessarily performed.

AnalogicTech and the AnalogicTech logo are trademarks of Advanced Analogic Technologies Incorporated. All other brand and product names appearing in this document are registered trademarks or trademarks of their respective holders.

Advanced Analogic Technologies, Inc.
 830 E. Arques Avenue, Sunnyvale, CA 94085
 Phone (408) 737-4600
 Fax (408) 737-4611

