

Data Sheet

Features

- For AMPS, CDMA and TDMA applications
- Usable bandwidth 25 MHz
- High attenuation
- No impedance matching required for operation at 50 Ω
- Single-ended operation
- Ceramic Surface Mount Package (SMP)
- Small size

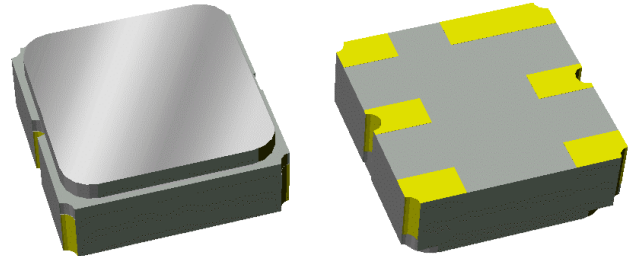

Package

Surface Mount 3.0 x 3.0 x 1.22 mm

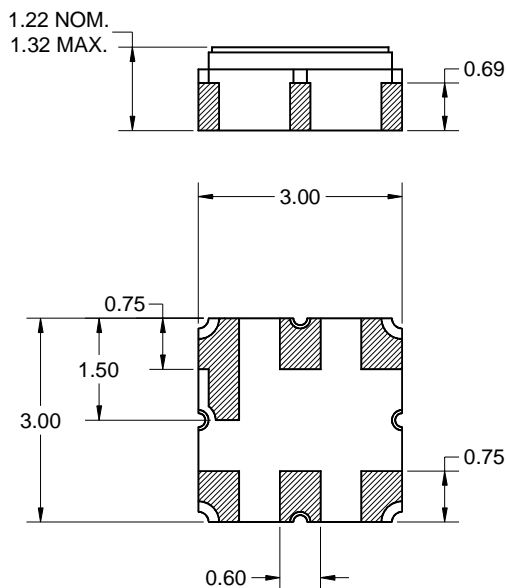

Pin Configuration

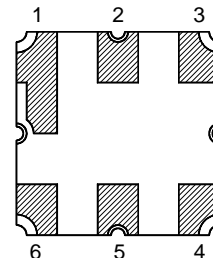

Pin No.	Description
2,5	Input/Output
1,3,4,6	Case ground

Dimensions shown are nominal in millimeters
 All tolerances are $\pm 0.15\text{mm}$ except overall
 length and width $\pm 0.10\text{mm}$

Body: Al_2O_3 ceramic
 Lid: Kovar, Ni plated
 Terminations: Au plating 0.5 - 1.0 μm ,
 over a 2 - 6 μm Ni plating

Data Sheet

Electrical Specifications ⁽¹⁾

Operating Temperature Range: ⁽²⁾ -30 to +85 °C

Parameter ⁽³⁾	Minimum	Typical	Maximum	Unit
Center Frequency	-	836.5	-	MHz
Maximum Insertion Loss 824 - 849 MHz	-	2.7	3.5	dB
Amplitude Variation 824 - 849 MHz	-	0.85	1.5	dB p-p
Absolute Attenuation DC - 800 MHz	40	50	-	dB
869 - 925 MHz	28	33	-	dB
925 - 2000 MHz	40	45	-	dB
Input/Output Return Loss 824 - 849 MHz	9.5	13.6	-	dB
Terminating Source Impedance: ⁽⁴⁾	-	50	-	Ω
Terminating Load Impedance: ⁽⁴⁾	-	50	-	Ω
Operating Temperature Range	-30	25	+85	°C

Notes:

1. All specifications are based on the test circuit shown below
2. In production, devices will be tested at room temperature to a guardbanded specification to ensure electrical compliance over temperature
3. Electrical margin has been built into the design to account for the variations due to temperature drift and manufacturing tolerances
4. This is the optimum impedance in order to achieve the performance shown

Test Circuit:

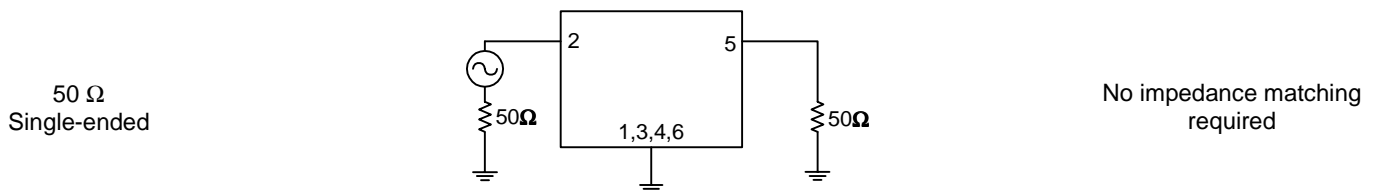

Data Sheet

Typical Performance (at +25°C)

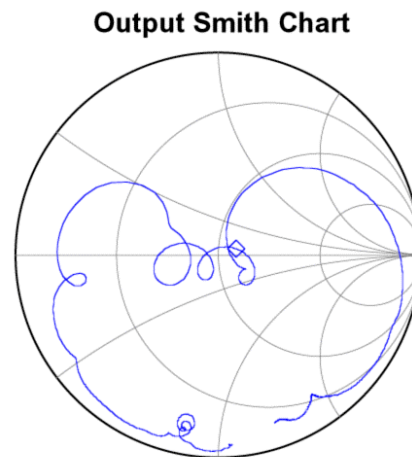
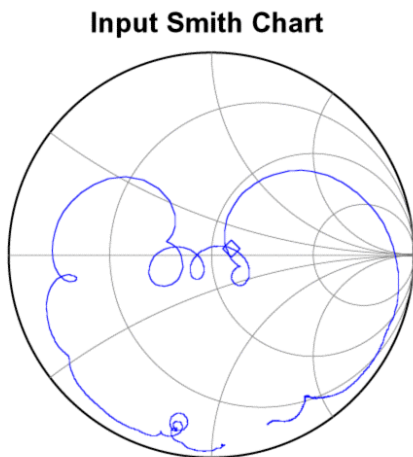
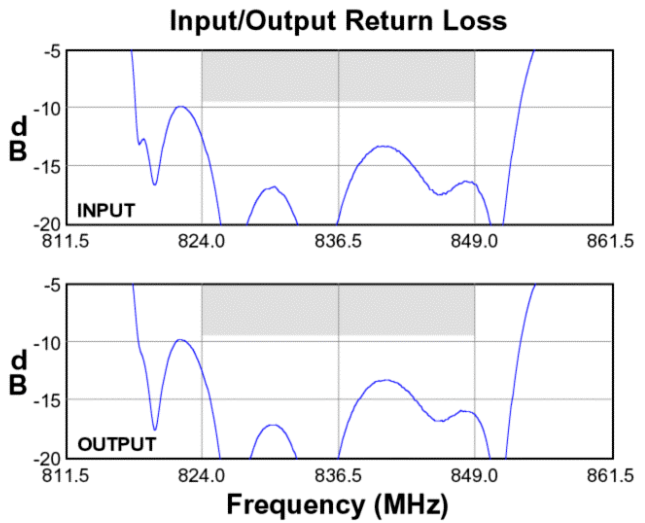
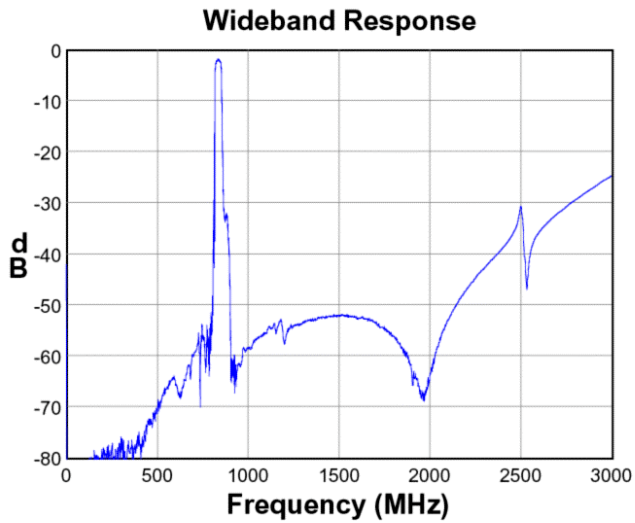
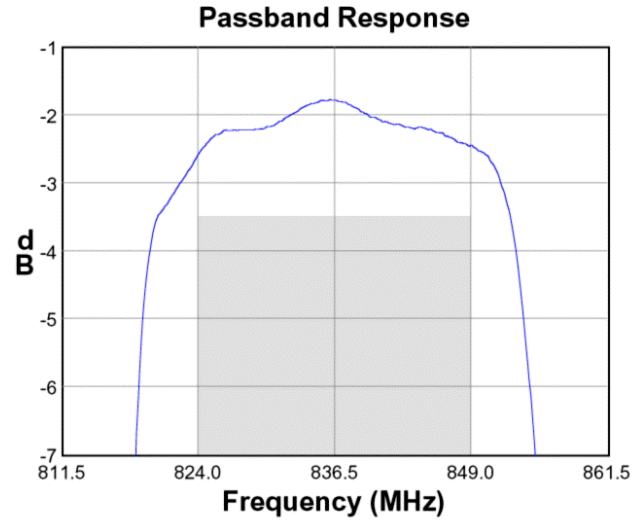
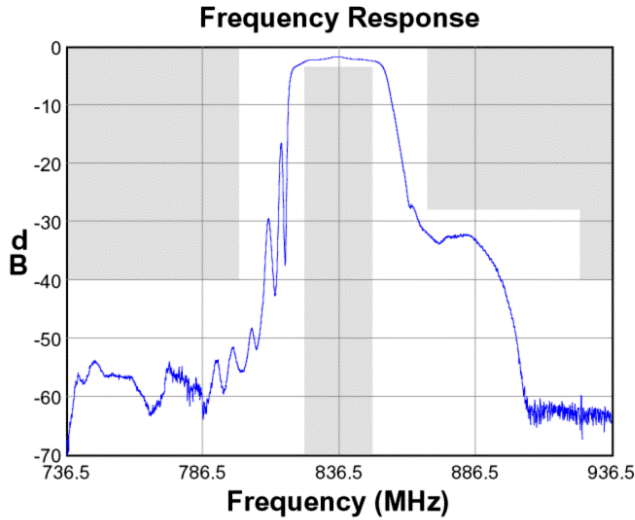

Data Sheet

Matching Schematics

50 Ω
Single-ended

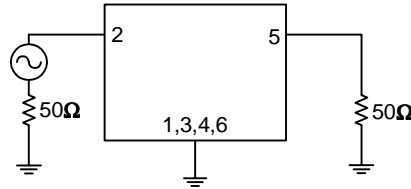

No impedance matching
required

Marking

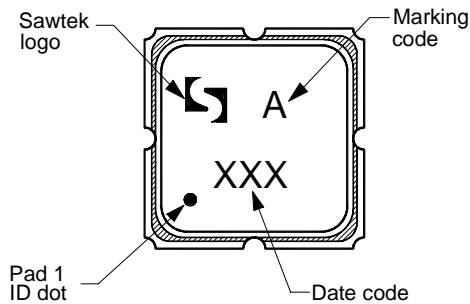

Date code is the day of the current year in 3-digit Julian format

PCB Footprint

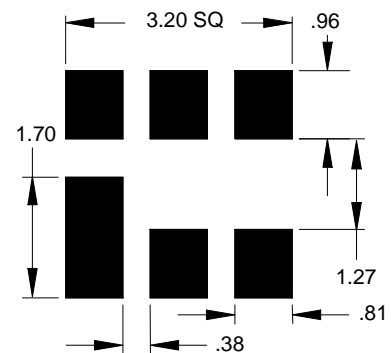

This footprint represents a recommendation only
Dimensions shown are nominal in millimeters

Tape and Reel

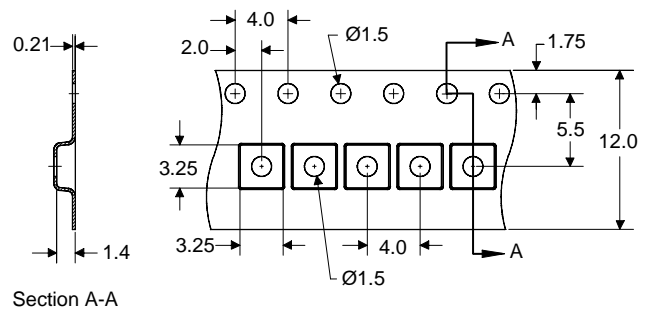
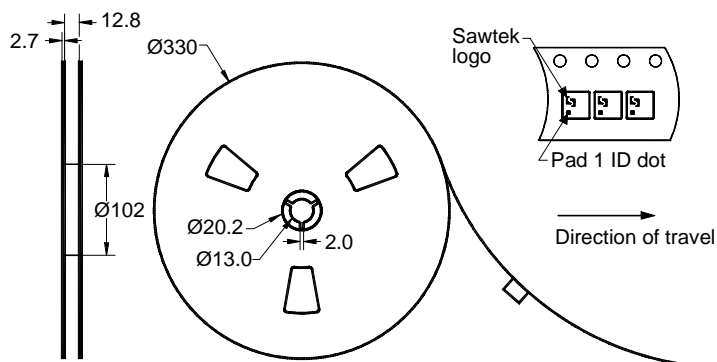

Dimensions shown are nominal in millimeters
Packaging quantity: 5000 units/reel

Data Sheet

Maximum Ratings

Parameter	Symbol	Minimum	Maximum	Unit
Operating Temperature Range	T	-30	+85	°C
Storage Temperature Range	T _{stg}	-40	+85	°C
RF Power	P _{in}	-	+10	dBm

Warnings

- Electrostatic Sensitive Device (ESD) 
- Avoid ultrasonic exposure

Links to Additional Technical Information

[PCB Layout Tips](#)

[Qualification Flowchart](#)

[Soldering Profile](#)

[S-Parameters](#)

[Reel and Packaging Label](#)

[Other Technical Information](#)

Contact Information



PO Box 609501
Orlando, FL 32860-9501
USA

Phone: +1 (407) 886-8860
Fax: +1 (407) 886-7061
Email: custservice@sawtek.com
Web: www.sawtek.com

Or contact one of our worldwide
network of [sales offices](#),
[representatives or distributors](#)