

### ■ Features

- Temperature protection provided by directly detecting the junction temperature of the IGBTs.
- Low power loss and soft switching.
- High performance and high reliability IGBT with overheating protection.
- Both P-side and N-side alarm output available.
- Higher reliability because of a big decrease in number of parts in built-in control circuit.

### ■ Maximum ratings and characteristics

- Absolute maximum ratings(at Tc=25°C unless otherwise specified)

Item		Symbol	Rating		Unit	
			Min.	Max.		
Bus voltage	DC	V <sub>DC</sub>	0	900	V	
	Surge	V <sub>DC(surge)</sub>	0	1000	V	
	Short operating	V <sub>SC</sub>	200	800	V	
Collector-Emitter voltage *1		V <sub>CES</sub>	0	1200	V	
Inverter	Collector current	DC	I <sub>C</sub>	-	75	A
		1ms	I <sub>CP</sub>	-	150	A
		Duty=76.1% *2	-I <sub>C</sub>	-	75	A
Collector power dissipation		One transistor *3	P <sub>C</sub>	-	500	W
Brake	Collector current	DC	I <sub>C</sub>	-	25	A
		1ms	I <sub>CP</sub>	-	50	A
	Forward Current of Diode		I <sub>F</sub>	-	25	A
	Collector power dissipation		One transistor *3	P <sub>C</sub>	-	198
Supply voltage of Pre-Driver *4		V <sub>CC</sub>	-0.5	20	V	
Input signal voltage *5		V <sub>in</sub>	-0.5	V <sub>CC</sub> +0.5	V	
Input signal current		I <sub>in</sub>	-	3	mA	
Alarm signal voltage *6		V <sub>ALM</sub>	-0.5	V <sub>CC</sub>	V	
Alarm signal current *7		I <sub>ALM</sub>	-	20	mA	
Junction temperature		T <sub>j</sub>	-	150	°C	
Operating case temperature		T <sub>opr</sub>	-20	100	°C	
Storage temperature		T <sub>stg</sub>	-40	125	°C	
Isolating voltage (Terminal to base, 50/60Hz sine wave 1min.)		V <sub>iso</sub>	-	AC2500	V	
Screw torque	Terminal (M5)		-	3.5	N·m	
	Mounting (M5)		-	3.5	N·m	

#### Note

\*1 : V<sub>CES</sub> shall be applied to the input voltage between terminal P and U or V or W or DB, N and U or V or W or DB.

\*2 :  $125^{\circ}\text{C}/\text{FRD } R_{th(j-c)}/(I_c \times V_F \text{ Max.})=125/0.73(75 \times 3.0) \times 100=76.1\%$

\*3 : P<sub>C</sub>=125°C/IGBT R<sub>th(j-c)</sub>=125/0.25=500W [Inverter]

P<sub>C</sub>=125°C/IGBT R<sub>th(j-c)</sub>=125/0.63=198W [Inverter]

\*4 : V<sub>CC</sub> shall be applied to the input voltage between terminal No.4 and 1, 8 and 5, 12 and 9, 14 and 13

\*5 : V<sub>in</sub> shall be applied to the input voltage between terminal No.3 and 1, 7 and 5, 11 and 9, 15,16,17,18 and 13.

\*6 : V<sub>ALM</sub> shall be applied to the voltage between terminal No.2 and 1, No6 and 5, No10 and 9, No.19 and 13.

\*7 : I<sub>ALM</sub> shall be applied to the input current to terminal No.2,6,10 and 19.

Electrical characteristics (at  $T_c=T_j=25^\circ\text{C}$ ,  $V_{cc}=15\text{V}$  unless otherwise specified.)

● Main circuit

Item		Symbol	Condition	Min.	Typ.	Max.	Unit	
Inverter	Collector current at off signal input	ICES	$V_{CE}=1200\text{V}$ $V_{in}$ terminal open.	-	-	1.0	mA	
	Collector-Emitter saturation voltage	$V_{CE(sat)}$	$I_c=75\text{A}$	Terminal	-	-	2.6	V
				Chip	-	-	-	
	Forward voltage of FWD	$V_F$	$-I_c=75\text{A}$	Terminal	-	-	3.0	V
Chip				-	-	-		
Brake	Collector current at off signal input	ICES	$V_{CE}=1200\text{V}$ $V_{in}$ terminal open.	-	-	1.0	mA	
	Collector-Emitter saturation voltage	$V_{CE(sat)}$	$I_c=25\text{A}$ Terminal	-	-	2.6	V	
	Forward voltage of Diode	$V_F$	$-I_c=25\text{A}$ Terminal	-	-	3.3	V	
Turn-on time		$t_{on}$	$V_{DC}=600\text{V}$ , $T_j=125^\circ\text{C}$	1.2	-	-	$\mu\text{s}$	
Turn-off time		$t_{off}$	$I_c=75\text{A}$ Fig.1, Fig.6	-	-	3.6		
Reverse recovery time		$t_{rr}$	$V_{DC}=600\text{V}$ , $I_F=75\text{A}$ Fig.1, Fig.6	-	-	0.3		

● Control circuit

Item	Symbol	Condition	Min.	Typ.	Max.	Unit
Supply current of P-line side pre-driver(one unit)	$I_{ccp}$	Switching Frequency : 0 to 15kHz	-	-	18	mA
Supply current of N-line side pre-driver	$I_{ccn}$	$T_c=-20$ to $125^\circ\text{C}$ Fig.7	-	-	65	mA
Input signal threshold voltage (on/off)	$V_{in(th)}$	ON	1.00	1.35	1.70	V
		OFF	1.25	1.60	1.95	V
Input zener voltage	$V_Z$	$R_{in}=20\text{k}\Omega$	-	8.0	-	V
Alarm signal hold time	$t_{ALM}$	$T_c=-20^\circ\text{C}$ Fig.2	1.1	-	-	ms
		$T_c=25^\circ\text{C}$ Fig.2	-	2.0	-	ms
		$T_c=125^\circ\text{C}$ Fig.2	-	-	4.0	ms
Limiting Resistor for Alarm	$R_{ALM}$		1425	1500	1575	$\Omega$

● Protection Section ( $V_{cc}=15\text{V}$ )

Item	Symbol	Condition	Min.	Typ.	Max.	Unit
Over Current Protection Level of Inverter circuit	$I_{oc}$	$T_j=125^\circ\text{C}$	113	-	-	A
Over Current Protection Level of Brake circuit	$I_{oc}$	$T_j=125^\circ\text{C}$	38	-	-	A
Over Current Protection Delay time	$t_{doc}$	$T_j=125^\circ\text{C}$	-	10	-	$\mu\text{s}$
SC Protection Delay time	$t_{sc}$	$T_j=125^\circ\text{C}$ Fig.4	-	-	12	$\mu\text{s}$
IGBT Chip Over Heating Protection Temperature Level	$T_{jOH}$	Surface of IGBT chips	150	-	-	$^\circ\text{C}$
Over Heating Protection Hysteresis	$T_{jH}$		-	20	-	$^\circ\text{C}$
Over Heating Protection Protection Temperature Level	$T_{cOH}$	$V_{dc}=0\text{V}$ , $I_c=0\text{A}$ Case Temperature	110	-	125	$^\circ\text{C}$
Over Heating Protection Hysteresis	$T_{cH}$		-	20	-	$^\circ\text{C}$
Under Voltage Protection Level	$V_{UV}$		11.0	-	12.5	V
Under Voltage Protection Hysteresis	$V_H$		0.2	0.5	-	V

● Thermal characteristics( $T_c=25^\circ\text{C}$ )

Item			Symbol	Min.	Typ.	Max.	Unit
Junction to Case thermal resistance *8	Inverter	IGBT	$R_{th(j-c)}$	-	-	0.25	$^\circ\text{C/W}$
		FWD	$R_{th(j-c)}$	-	-	0.73	$^\circ\text{C/W}$
	Brake	IGBT	$R_{th(j-c)}$	-	-	0.63	$^\circ\text{C/W}$
Case to fin thermal resistance with compound			$R_{th(c-f)}$	-	0.05	-	

\*8 : (For 1 device, Case is under the device)

● Noise Immunity ( $V_{DC}=300\text{V}$ ,  $V_{cc}=15\text{V}$ , Test Circuit Fig.5)

Item	Condition	Min.	Typ.	Max.	Unit
Common mode rectangular noise	Pulse width $1\mu\text{s}$ , polarity $\pm$ , 10minuets Judge : no over-current, no miss operating	$\pm 2.0$	-	-	kV
Common mode lightning surge	Rise time $1.2\mu\text{s}$ , Fall time $50\mu\text{s}$ Interval 20s, 10 times Judge : no over-current, no miss operating	$\pm 5.0$	-	-	kV

● Recommendable value

Item	Symbol	Min.	Typ.	Max.	Unit
DC Bus Voltage	$V_{DC}$	-	-	800	V
Operating Supply Voltage of Pre-Driver	$V_{cc}$	13.5	15.0	16.5	V
Screw torque (M5)	-	2.5	-	3.0	Nm

● Weight

Item	Symbol	Min.	Typ.	Max.	Unit
Weight	$W_t$	-	450	-	g

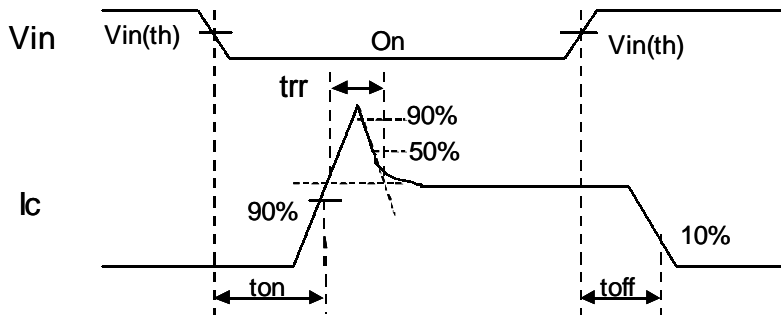

Figure 1. Switching Time Waveform Definitions



Fault : Over-current, Over-heat or Under-voltage

Figure 2. Input/Output Timing Diagram

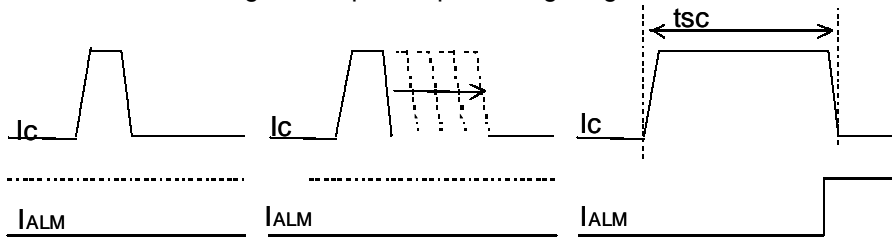

Figure.4 Definition of tsc



Figure 5. Noise Test Circuit

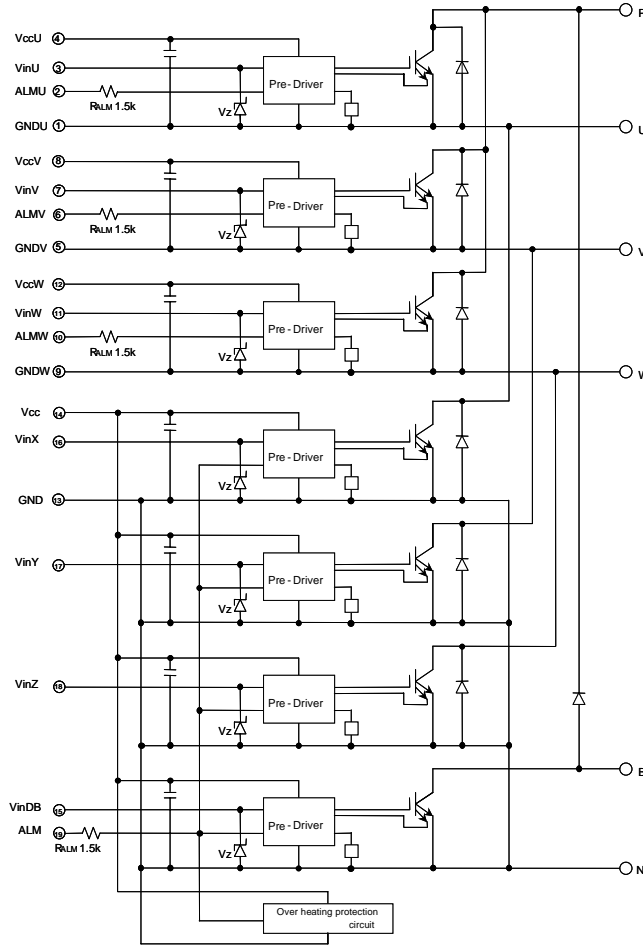

Figure 6. Switching Characteristics Test Circuit



Figure 7. Icc Test Circuit

Block diagram



Pre-drivers include following functions

1. Amplifier for driver
2. Short circuit protection
3. Under voltage lockout circuit
4. Over current protection
5. IGBT chip over heating protection

Outline drawings, mm

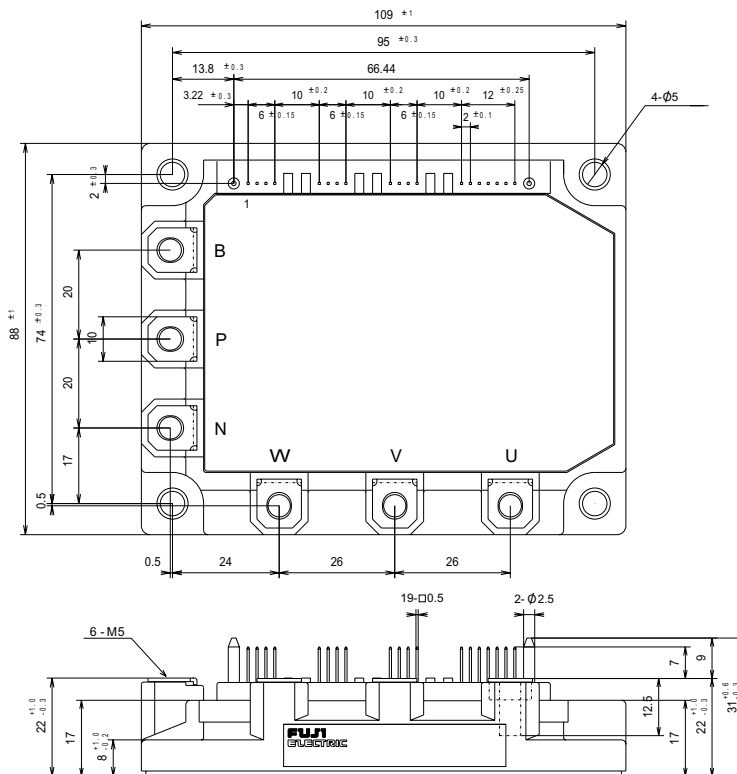

Mass : 450g

Characteristics

Control circuit characteristics (Representative)

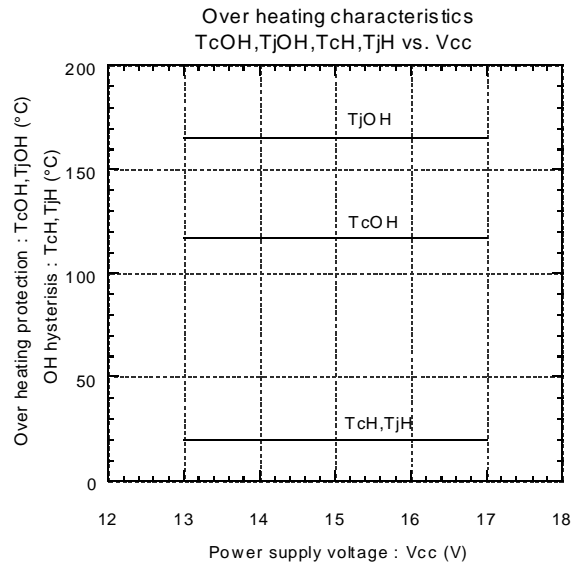
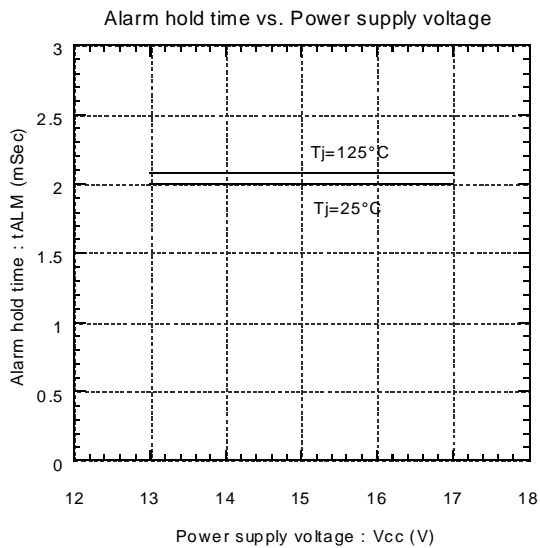
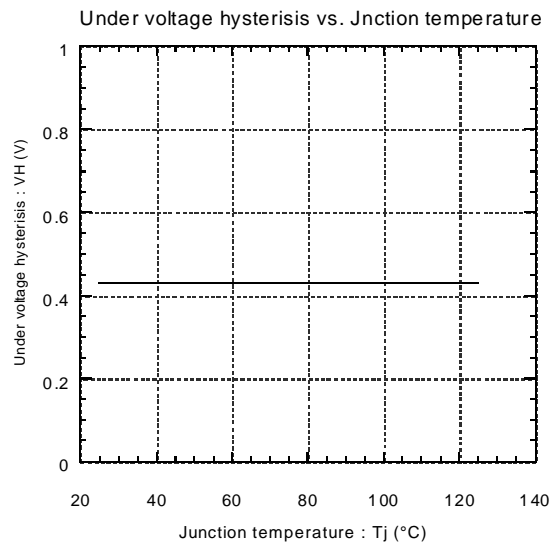
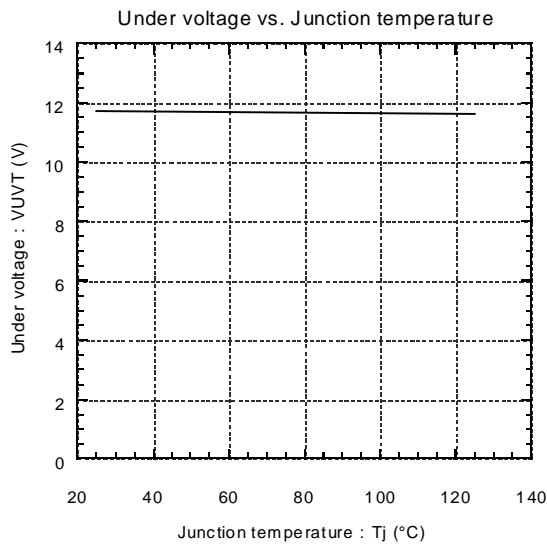
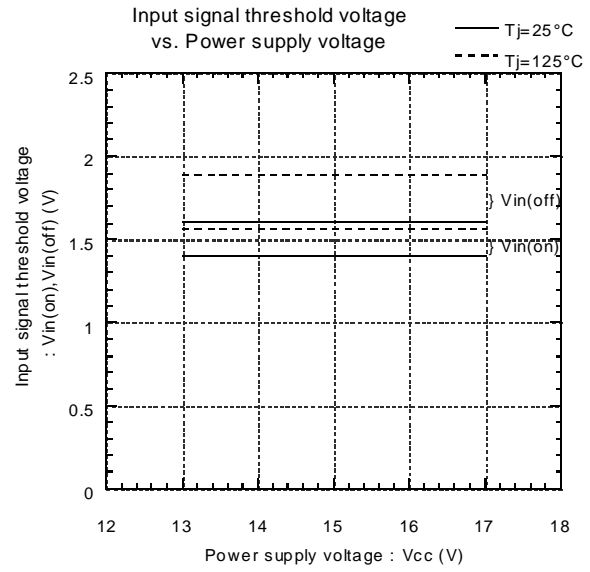
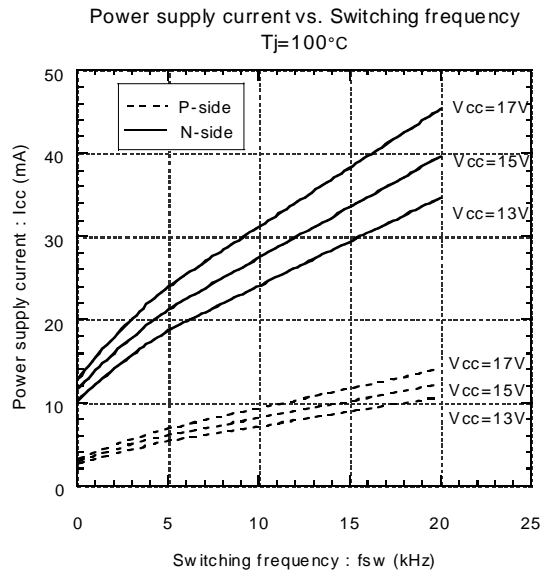

● Main circuit characteristics (Representative)

Collector current vs. Collector-Emitter voltage  
Tj=25°C(Chip)

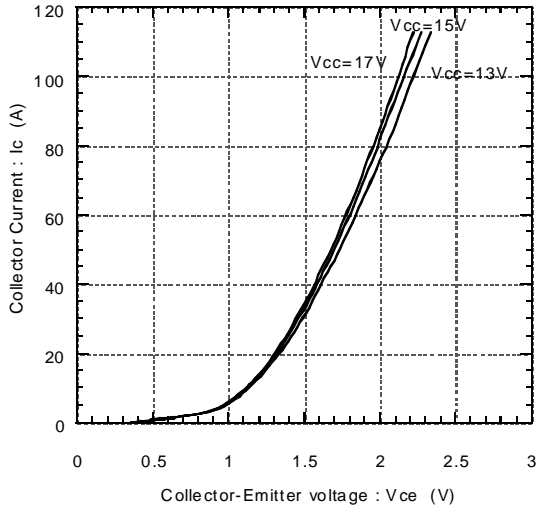

Collector current vs. Collector-Emitter voltage  
Tj=25°C(Terminal)

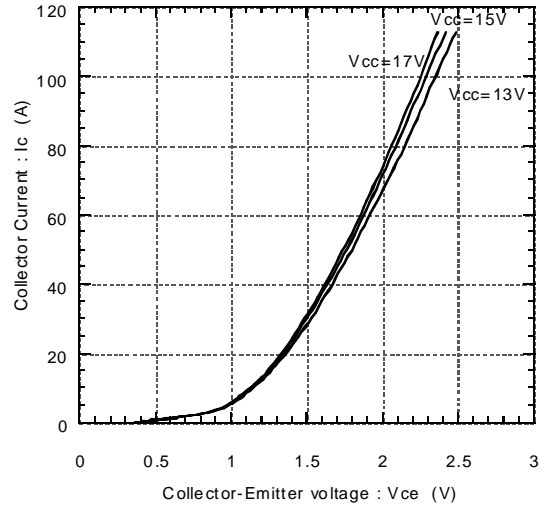

Collector current vs. Collector-Emitter voltage  
Tj=125°C(Chip)

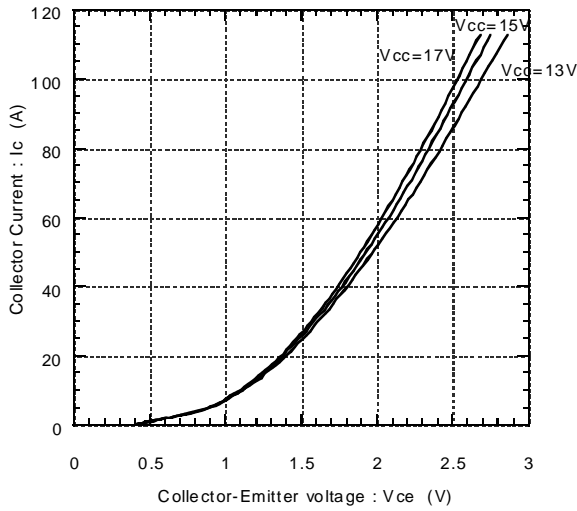

Collector current vs. Collector-Emitter voltage  
Tj=125°C(Terminal)

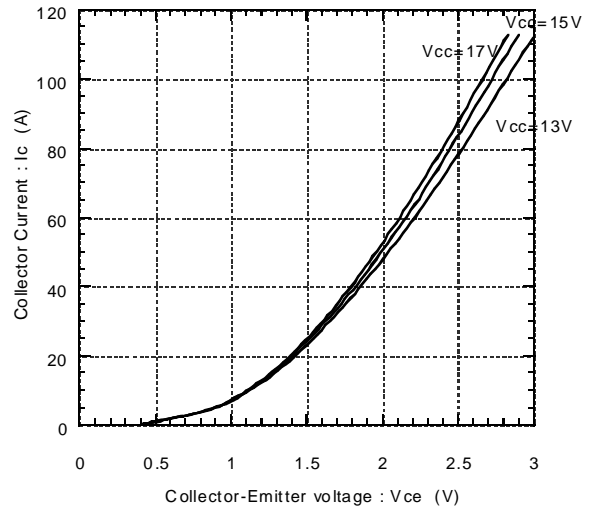

Forward current vs. Forward voltage  
(Chip)

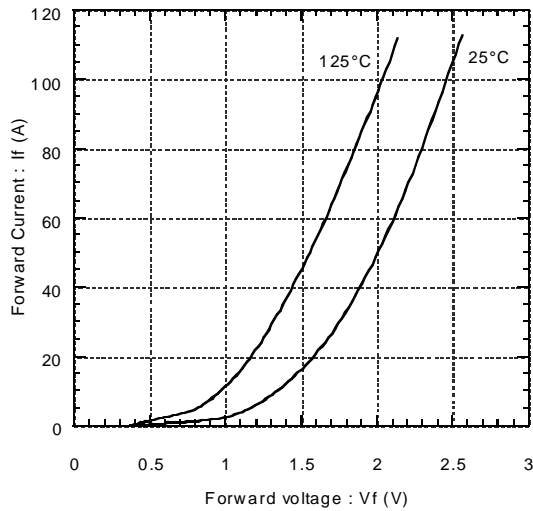

Forward current vs. Forward voltage  
(Terminal)

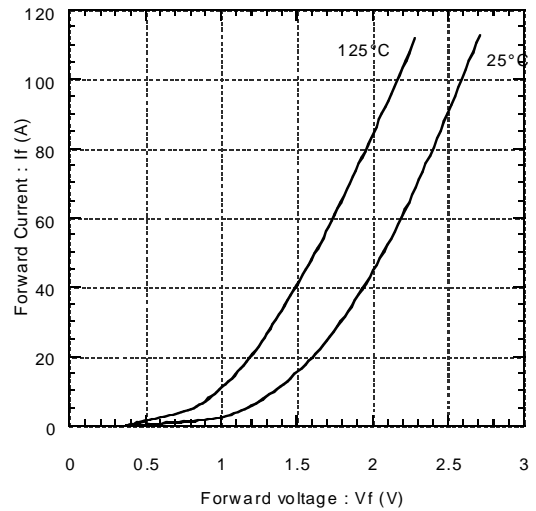

Switching Loss vs. Collector Current  
 $E_{dc}=600V, V_{cc}=15V, T_j=25^\circ C$

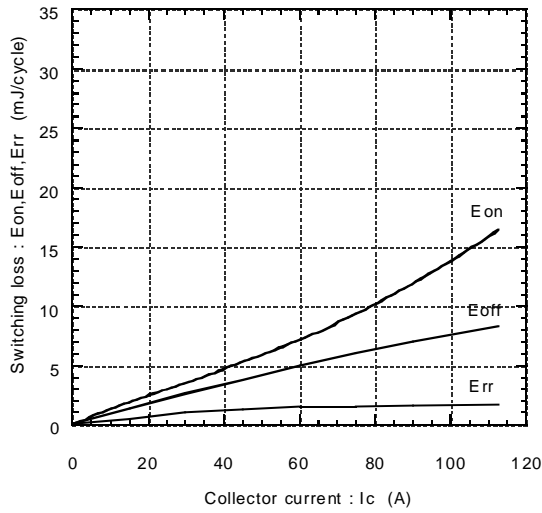

Switching Loss vs. Collector Current  
 $E_{dc}=600V, V_{cc}=15V, T_j=125^\circ C$

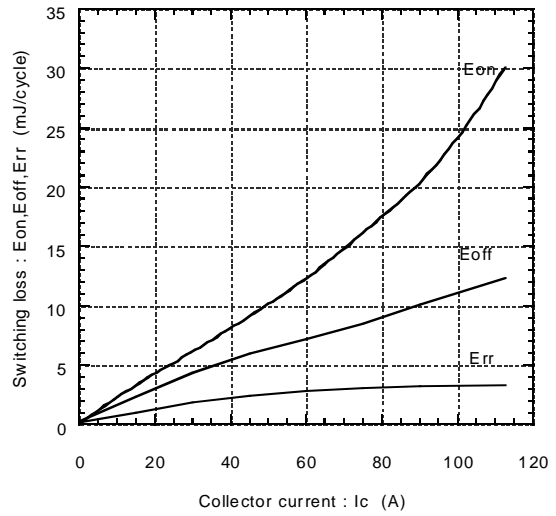

Reversed biased safe operating area  
 $V_{cc}=15V, T_j \le 125^\circ C$

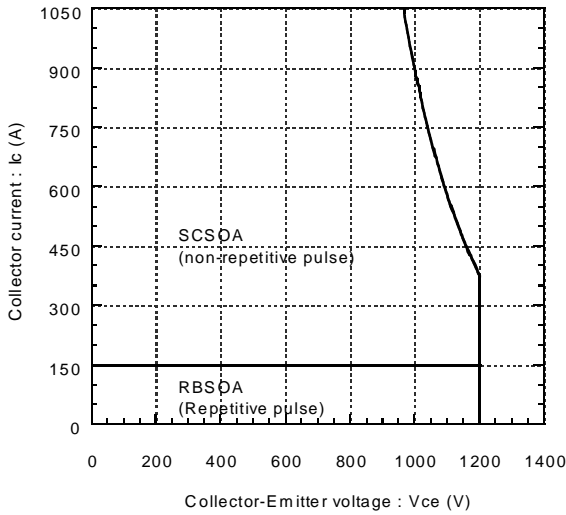

Transient thermal resistance

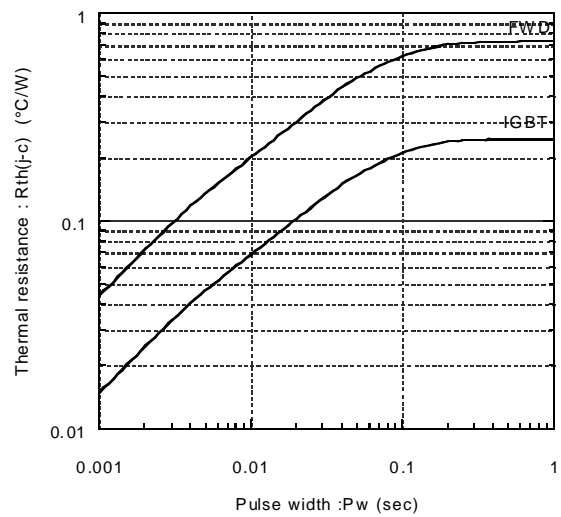

Power derating for IGBT  
(per device)

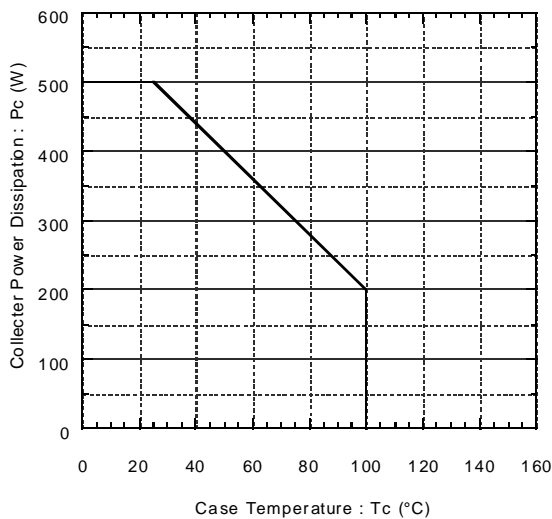

Power derating for FWD  
(per device)

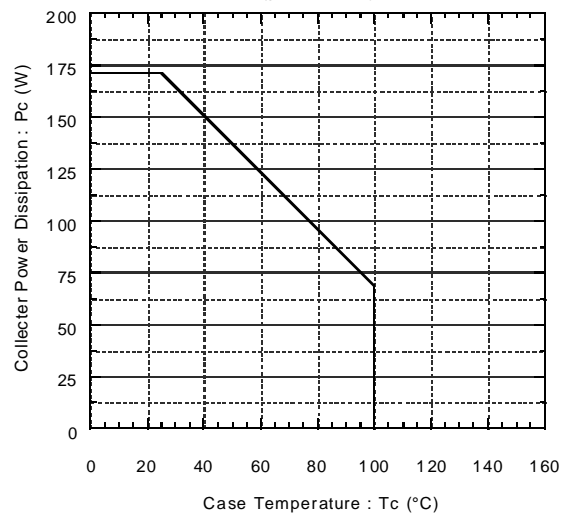

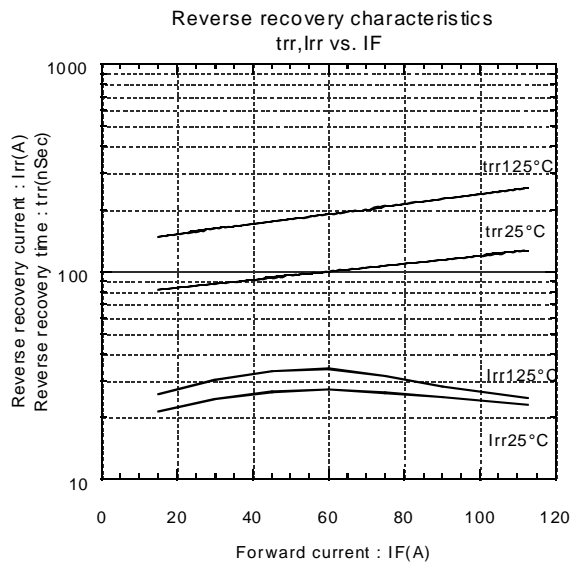
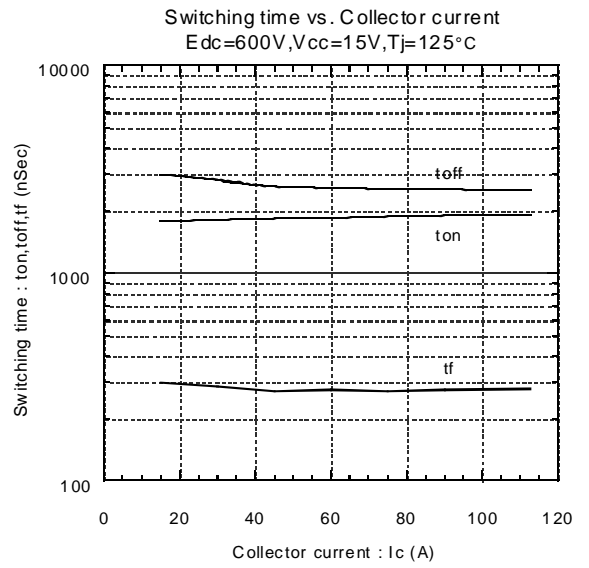
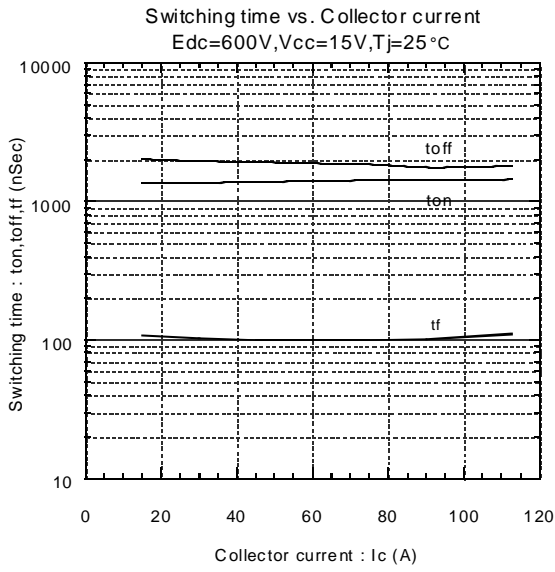



● Dynamic Brake Characteristics (Representative)

