

SPECIFICATION

Device Name : IGBT-IPM

Type Name : 7MBP75RE120

Spec. No. : MS6M 0350

This material and the information herein is the property of Fuji Electric Co., Ltd. They shall be neither reproduced, copied, lent, or disclosed in any way whatsoever for the use of any third party, nor used for the manufacturing purpose without the express written consent of Fuji Electric Co., Ltd.

Fuji Electric Co., Ltd.
Matsumoto Factory

	DATE	NAME	APPROVED	
DRAWN	98 Jun 01	Yamaguchi		Fuji Electric Co., Ltd.
CHECKED	98 Jun 01	(Nishikawa)		
			C. Kobayashi	MS6M 0350 1/16

Revised Records

Date	Classification	Ind.	Content	Applied date	Drawn	Checked	Approved
'98 Jun-01	enactment	—	—————	Issued date	Yanaguchi	Nishiura	S.K.

This material and the information herein is the property of Fuji Electric Co., Ltd. It shall be neither reproduced, copied, lent, or disclosed in any way whatsoever for the use of any third party nor used for the manufacturing purposes without the express written consent of Fuji Electric Co., Ltd.

1. Outline

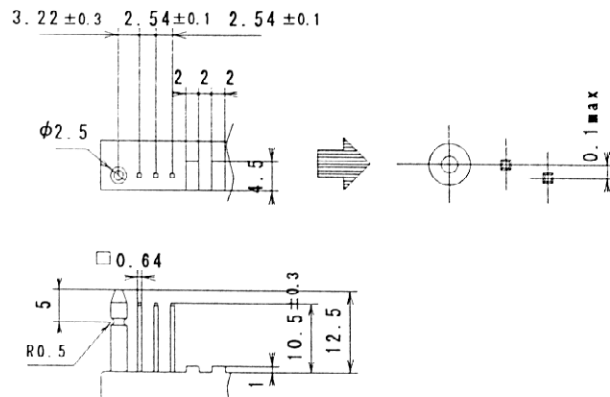
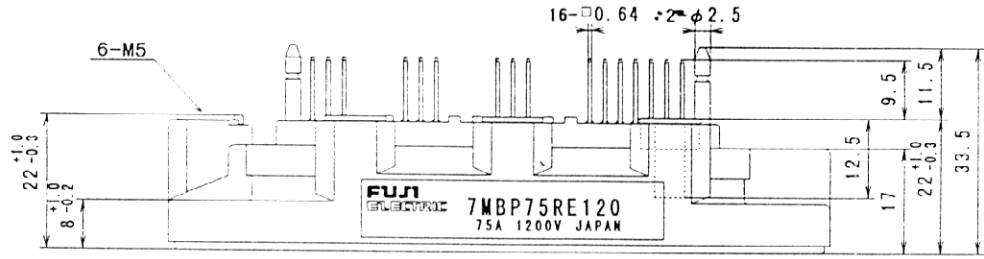
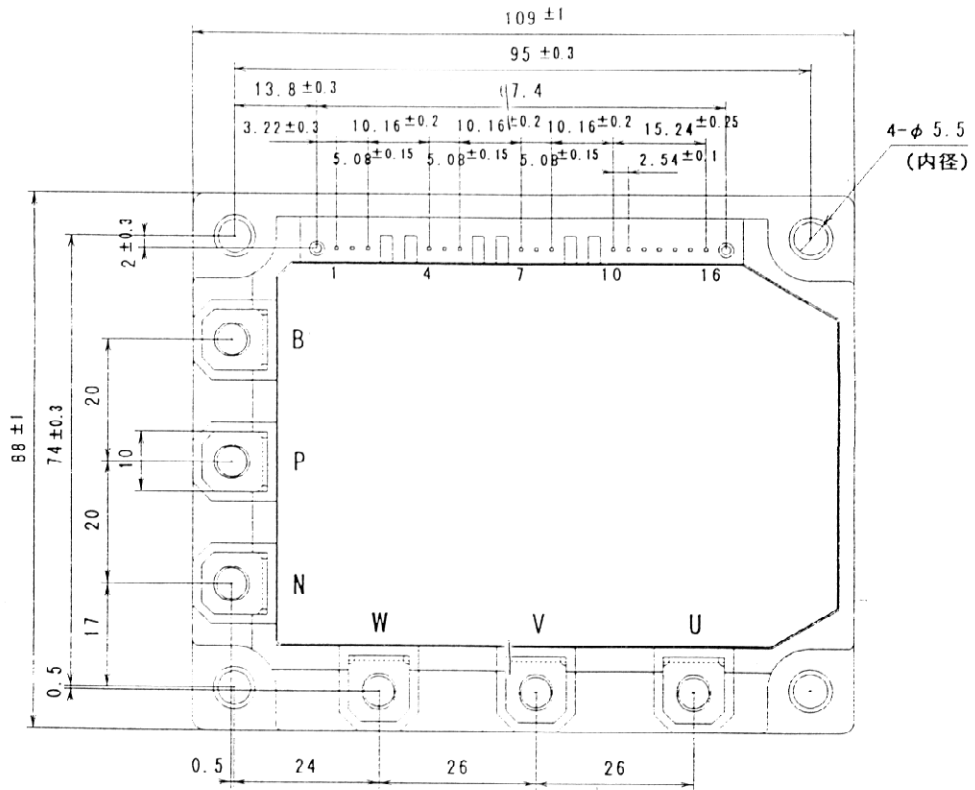

Details of control terminals

This material and the information herein is the property of Fuji Electric Co., Ltd. They shall be neither reproduced, copied, lent, or disclosed in any way whatsoever for the use of any third party, nor used for the manufacturing purpose without the express written consent of Fuji Electric Co., Ltd.

2. Block Diagram

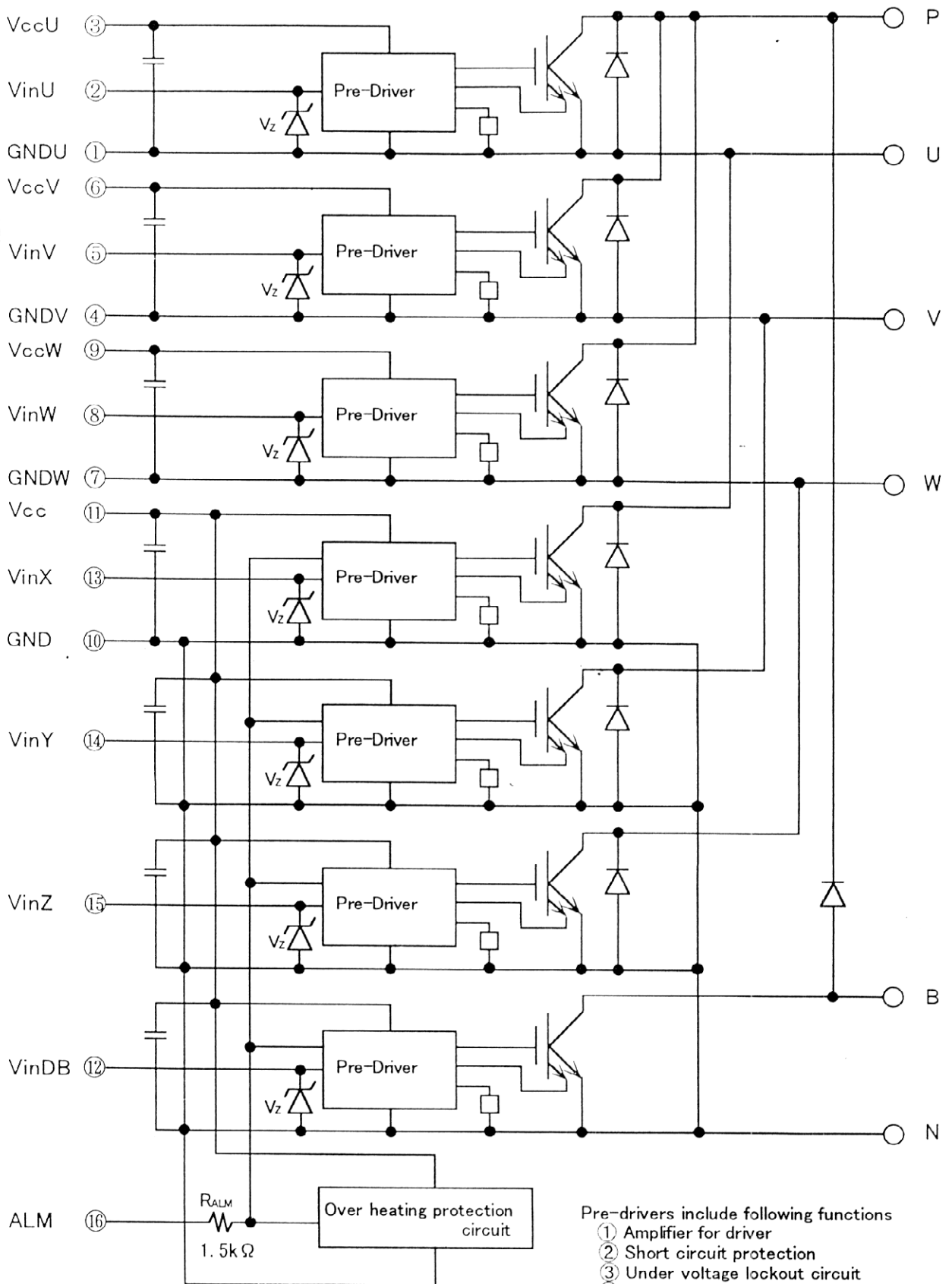

This material and the information herein is the property of Fuji Electric Co., Ltd. They shall be neither reproduced, copied, lent, or disclosed in any way whatsoever for the use of any third party, nor used for the manufacturing purposes without the express written consent of Fuji Electric Co., Ltd.

- Pre-drivers include following functions
- ① Amplifier for driver
 - ② Short circuit protection
 - ③ Under voltage lockout circuit
 - ④ Over current protection
 - ⑤ IGBT chip over heating protection

3. Absolute Maximum Ratings (at Tc=25°C unless otherwise specified)
絶対最大定格

Items		Symbols	Ratings		Unit	
			min.	max.		
DC Bus Voltage		V _{DC}	0	900	V	
DC Bus Voltage (surge)		V _{DC(surge)}	0	1000	V	
DC Bus Voltage (short operating)		V _{SC}	200	800	V	
Collector-Emitter Voltage		V _{CES}	0	1200	V	
DB Reverse Voltage		V _R	0	1200	V	
INV	Collector Current	DC	I _C	—	75	A
		1 mS	I _{CP}	—	150	A
		DC	-I _C	—	75	A
Collector Power Dissipation		One Transistor	P _C	—	500	W
DB	Collector Current	DC	I _C	—	25	A
		1 mS	I _{CP}	—	50	A
	Forward Current of Diode		I _F	—	25	A
	Collector Power Dissipation		One Transistor	P _C	—	198
Junction Temperature		T _j	—	150	°C	
Input Voltage of Power Supply for Pre-Driver		V _{CC} *1	0	20	V	
Input Signal Voltage		V _{in} *2	0	V _z	V	
Input Signal Current		I _{in}	—	1	mA	
Alarm Signal Voltage		V _{ALM} *3	0	V _{CC}	V	
Alarm Signal Current		I _{ALM} *4	—	15	mA	
Storage Temperature		T _{stg}	-40	125	°C	
Operating Case Temperature		T _{op}	-20	100	°C	
Isolating Voltage (Case-Terminal)		V _{iso} *5	—	AC2500	V	
Screw Torque	Mounting(M5)	—	—	3.5 *6	N·m	
	Terminal (M5)	—	—	3.5 *6	N·m	

This material and the information herein is the property of Fuji Electric Co., Ltd. They shall be neither reproduced, copied, lent, or disclosed in any way whatsoever for the use of any third party, nor used for the manufacturing purposes without the express written consent of Fuji Electric Co., Ltd.

Note

- *1 : V_{CC} shall be applied to the input voltage between terminal No.3 and 1, 6 and 4, 9 and 7, 11 and 10
- *2 : V_{in} shall be applied to the input voltage between terminal No.2 and 1, 5 and 4, 8 and 7, 12,13,14,15 and 10.
- *3 : V_{ALM} shall be applied to the voltage between terminal No.16 and 10.
- *4 : I_{ALM} shall be applied to the input current to terminal No.16.
- *5 : 50Hz/60Hz sine wave 1 minute.
- *6 : Recommendable Value : 2.5~3.0 N·m

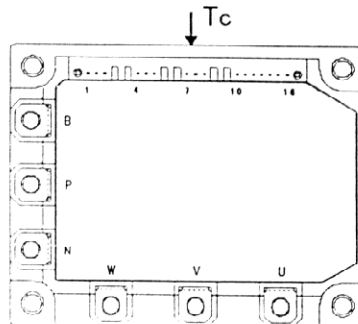

Fig. 1 Measurement of case temperature (Tc) for TcOH

4. Electrical Characteristics

電気的特性

4. 1 Electrical Characteristics of Power Circuit (at $T_c=T_j=25^\circ\text{C}$, $V_{cc}=15\text{V}$)

Items		Symbols	Conditions	min.	typ.	max.	Unit
INV	Collector Current at off Signal Input	I_{CES}	$V_{CE}=1200\text{V}$ Input Terminal Open	—	—	1.0	mA
	Collector-Emitter Saturation Voltage	$V_{CE(sat)}$	$I_c=75\text{A}$	—	—	2.6	V
	Forward Voltage of FWD	V_F	$-I_c=75\text{A}$	—	—	3.0	V
DB	Collector Current at off Signal Input	I_{CES}	$V_{CE}=1200\text{V}$ Input Terminal Open	—	—	1.0	mA
	Collector-Emitter Saturation Voltage	$V_{CE(sat)}$	$I_c=25\text{A}$	—	—	2.6	V
	Forward Voltage of Diode	V_F	$-I_c=25\text{A}$	—	—	3.3	V

4. 2 Electrical Characteristics of Control Circuit (at $T_c=T_j=25^\circ\text{C}$, $V_{cc}=15\text{V}$)

Items		Symbols	Conditions	min.	typ.	max.	Unit
Power Supply Current of P-line Side Pre-driver (one unit)		I_{CCP}	$f_{sw}=0\sim 15\text{kHz} *7$ $T_c=-20\sim 100^\circ\text{C}$	3	—	18	mA
Power Supply Current of N-line Side three Pre-driver		I_{CCN}	$f_{sw}=0\sim 15\text{kHz} *7$ $T_c=-20\sim 100^\circ\text{C}$	10	—	65	mA
Input Signal Threshold Voltage (on/off)	$V_{in(th)}$	ON		1.00	1.35	1.70	V
		OFF		1.25	1.60	1.95	
Input Zener Voltage		V_z	$R_{in}=20\text{k}\Omega$	—	8.0	—	V

*7 : Switching frequency of IPM

Over Heating Protective Section ($V_{cc}=15\text{V}$)

Items		Symbols	Conditions	min.	typ.	max.	Unit
Over Heating Protection Temperature Level		T_{COH}	$V_{DC}=0\text{V}$, $I_c=0\text{A}$, Fig.1 Case Temperature	110	—	125	$^\circ\text{C}$
Hysteresis		T_{CH}	—	—	20	—	$^\circ\text{C}$
IGBT chips Over Heating Protection Temperature Level		T_{JOH}	surface of IGBT chips	150	—	—	$^\circ\text{C}$
Hysteresis		T_{JH}	—	—	20	—	$^\circ\text{C}$

Over Current Protection Section ($V_{cc}=15\text{V}$)

Items		Symbols	Conditions	min.	typ.	max.	Unit
INV	Collector Current Protection Level	I_{OC}	$T_j=125^\circ\text{C}$	113	—	—	A
	Protection Delay	t_{boc}	Fig.2 $T_j=25^\circ\text{C}$	—	5	—	μS
	SC Protection Delay	t_{sc}	Fig.3 $T_j=25^\circ\text{C}$	—	—	10	
DB	Collector Current Protection Level	I_{OC}	$T_j=125^\circ\text{C}$	38	—	—	A
	Protection Delay	t_{boc}	Fig.2 $T_j=25^\circ\text{C}$	—	10	—	μS
	SC Protection Delay	t_{sc}	Fig.3 $T_j=25^\circ\text{C}$	—	—	12	

This material and the information herein is the property of Fuji Electric Co., Ltd. They shall be neither reproduced, copied, lent, or disclosed in any way whatsoever for the use of any third party nor used for the manufacturing purposes without the express written consent of Fuji Electric Co., Ltd.

Alarm Signal Output Section (at $T_j=T_c=25^\circ\text{C}$, $V_{cc}=15\text{V}$)

Items	Symbols	Conditions	min.	typ.	max.	Unit
Alarm Signal Hold Time	t_{ALM}	—	1.5	2	—	mS
Limiting resistor for Alarm	R_{ALM}	—	1425	1500	1575	Ω

Under Voltage Lockout Section (at $T_j=T_c=25^\circ\text{C}$, $V_{cc}=15\text{V}$)

Items	Symbols	Conditions	min.	typ.	max.	Unit
Under Voltage Protection Level	V_{UV}	—	11.0	—	12.5	V
Hysteresis	V_{H}	—	0.2	—	—	V

5. Dynamic Characteristics (at $T_c=T_j=125^\circ\text{C}$, $V_{CC}=15\text{V}$)

スイッチング特性

Items	Symbols	Conditions	min.	typ.	max.	Unit
Switching Time (IGBT)	t_{on}	$I_c=75\text{A}$, $V_{\text{DC}}=600\text{V}$	0.3	—	—	μS
	t_{off}					
Switching Time (FWD)	t_{rr}	$I_f=75\text{A}$, $V_{\text{DC}}=600\text{V}$	—	—	0.4	

6. Thermal Characteristics ($T_c=25^\circ\text{C}$)

熱特性

Items	Symbols	min.	typ.	max.	Unit
Junction to Case Thermal Resistance	INV IGBT	$R_{\text{th}(j-c)}$	—	—	0.25
	FWD	$R_{\text{th}(j-c)}$	—	—	0.73
Junction to Case Thermal Resistance	DB IGBT	$R_{\text{th}(j-c)}$	—	—	0.63
Case to Fin Thermal Resistance with Compound	$R_{\text{th}(c-f)}$	—	0.05	—	$^\circ\text{C}/\text{W}$

7. Recommendable Value

推奨値

Items	Symbols	Conditions	min.	typ.	max.	Unit	
DC Bus Voltage	V_{DC}	—	200	—	800	V	
Operating Power Supply Voltage Range of Pre-driver	V_{CC}	—	13.5	15	16.5	V	
Switching frequency of IPM	f_{sw}	—	1	—	20	kHz	
Screw torque	Mounting(M5)	—	—	2.5	—	3.0	N·m
	Terminal (M5)	—	—	2.5	—	3.0	N·m

8. Weight

重量

Items	min.	typ.	max.	Unit
Weight	—	440	—	g

This material and the information herein is the property of Fuji Electric Co., Ltd. They shall be neither reproduced, copied, lent, or disclosed in any way whatsoever for the use of any third party nor used for the manufacturing purposes without the express written consent of Fuji Electric Co., Ltd.

This material and the information herein is the property of Fuji Electric Co., Ltd. They shall be neither reproduced, copied, lent, or disclosed in any way whatsoever for the use of any third party nor used for the manufacturing purposes without the express written consent of Fuji Electric Co., Ltd.

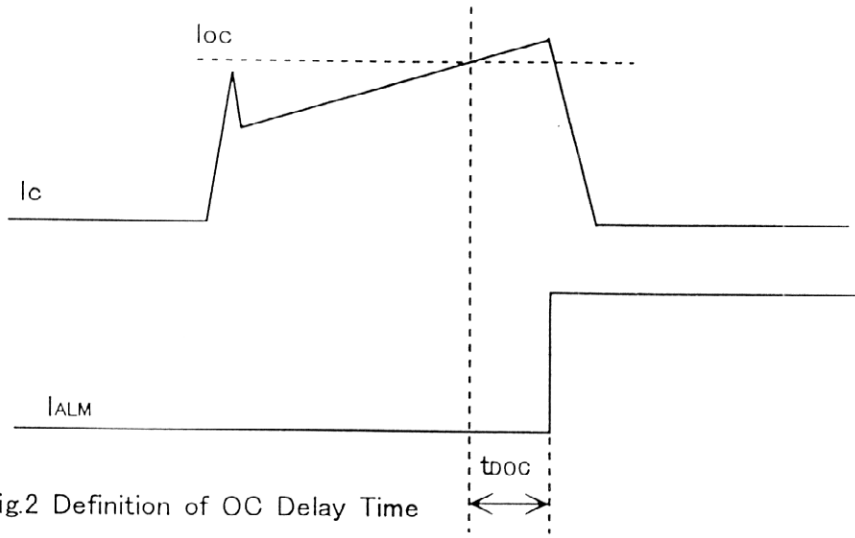

Fig.2 Definition of OC Delay Time

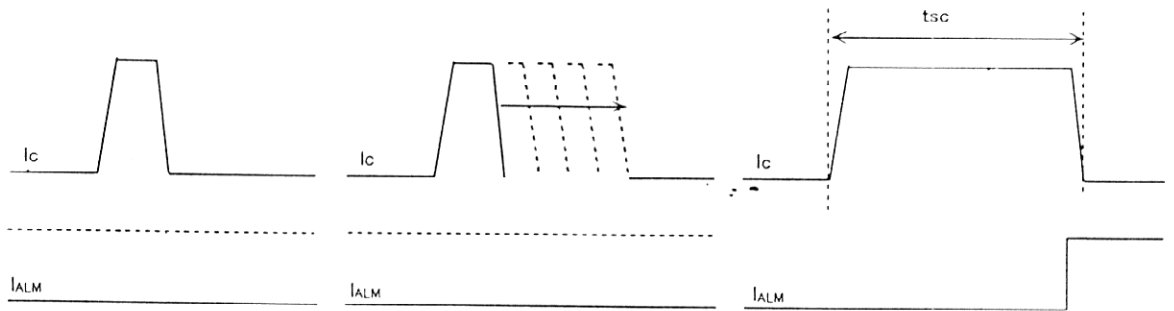

Fig.3 Definition of tsc

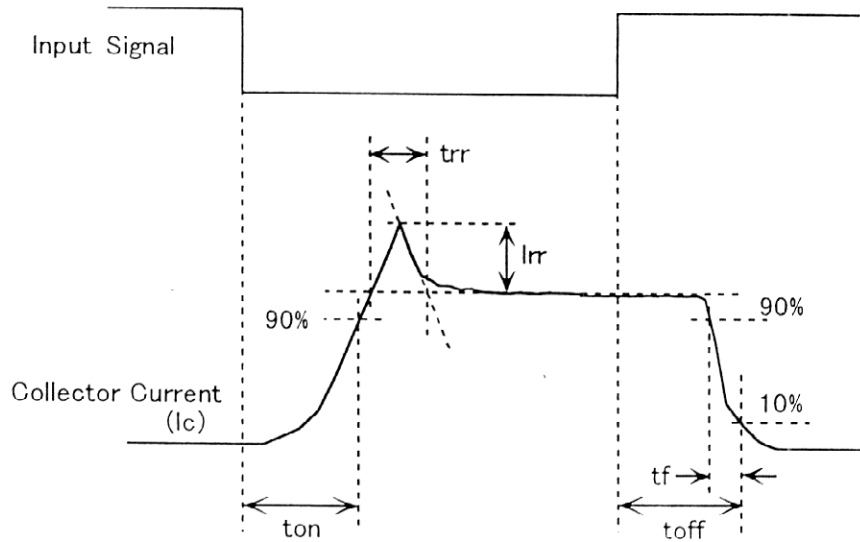
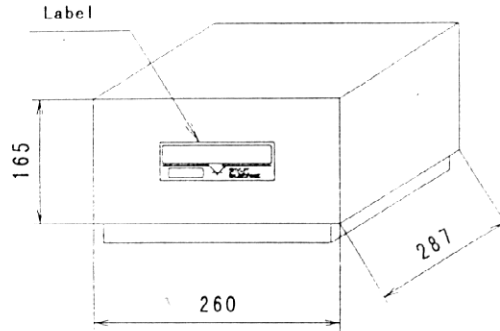

Fig.4 Definition of Switching Time

9. Packing and labeling (梱包箱と表示)

Outer carton (外箱)



material: corrugated cardboard
 材料 ダンボール
 weight : 5.0kg(max.)
 総重量 約5.0kg(最大)
 products: 10pcs(max.)
 製品 10個(最大)

Inner carton (内装箱)

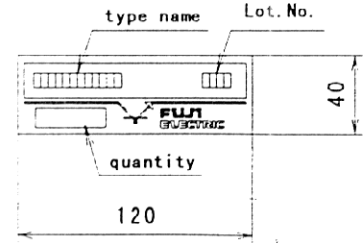
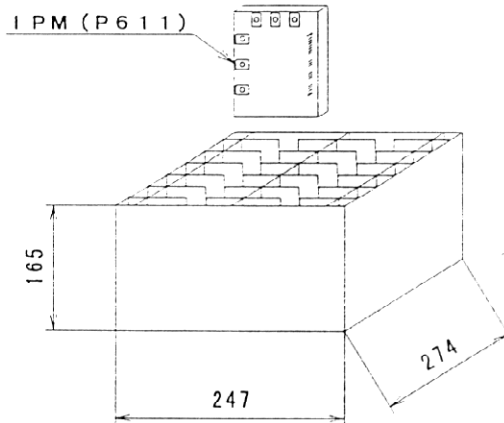

This material and the information herein is the property of Fuji Electric Co., Ltd. They shall be neither reproduced, copied, lent, or disclosed in any way whatsoever for the use of any third party nor used for the manufacturing purpose without the express written consent of Fuji Electric Co., Ltd.

10. Storage and transportation notes (保管、運搬上の注意事項)

- The IGBT-IPM should be stored at a standard temperature of 5 to 35°C and humidity of 45 to 75%.
 室内で常温常湿保存が望ましい。(5~35°C、45~75%)
- Store modules in a place with few temperature changes in order to avoid condensation on the module surface.
 急激な温度変化がないこと。(モジュール表面が結露しないこと)
- Avoid exposure to corrosive gases and dust.
 腐食性ガスの発生場所、塵埃の多い場所は避けること。
- Avoid excessive external force on the module.
 半導体製品に荷重がかからない様に注意すること。
- Store modules with unprocessed terminals.
 モジュールの端子は未加工の状態 で保管すること。
- Don't drop or otherwise shock the modules when transporting.
 運搬時に衝撃を与えたり落下させないこと。

11. Operation environment (使用環境)

Avoid exposure to corrosive gases.
 腐食性ガスの雰囲気での使用は避けること。

12. Applicable category (適用範囲)

This specification is applied to IGBT-IPM named 7MBP75RE120.
 本仕様書は、IGBT-IPM(型式:7MBP75RE120)に適用する。

13. UL approval (準拠安全規格)

UL840 (Operating condition: Table 6. 1—Operating voltage 500V, Pollution degree 2, Material group III a)
 (適用条件: 表6. 1—動作電圧500V、汚れ度2、材料グループⅢa)

UL94V-0

14. Characteristics (Representative)

特性カーブ (代表例)

14-1. Control Circuit

制御部

Power supply current vs. Switching frequency
T_j=100°C

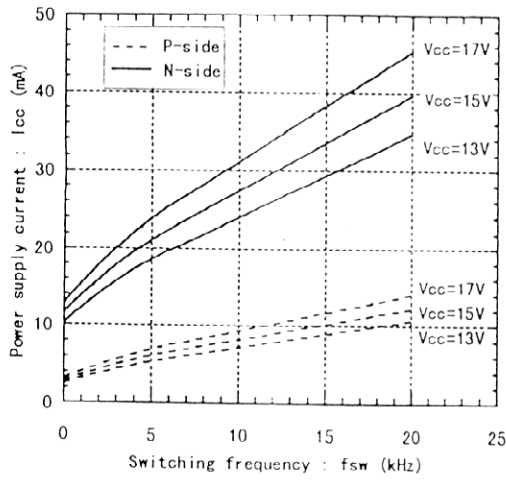

Input signal threshold voltage vs. Power supply voltage
— T_j=25°C
--- T_j=125°C

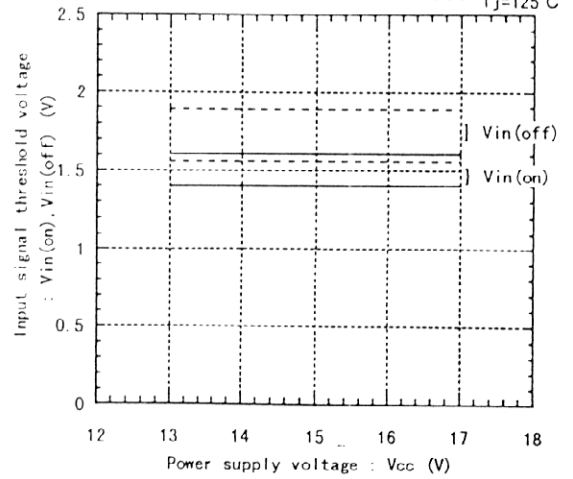

Under voltage vs. Junction temperature

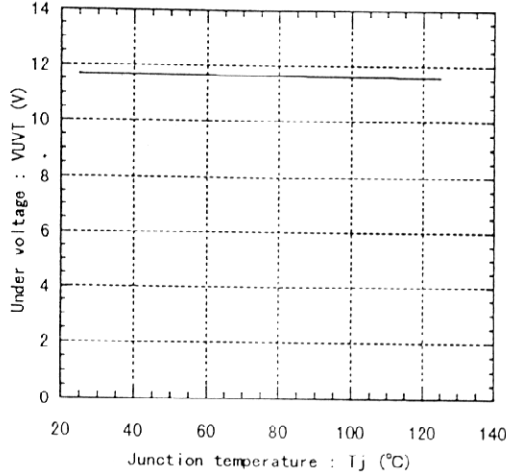

Under voltage hysteresis vs. Junction temperature

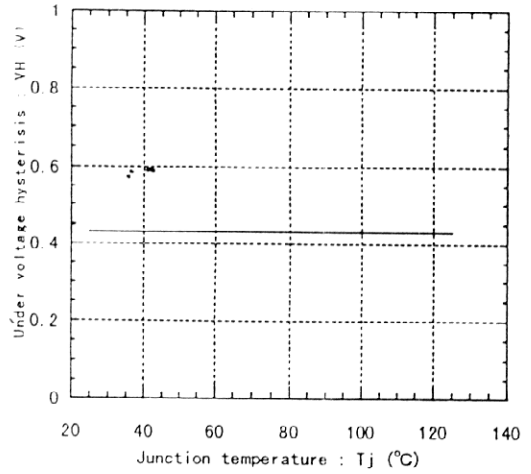

Alarm hold time vs. Power supply voltage

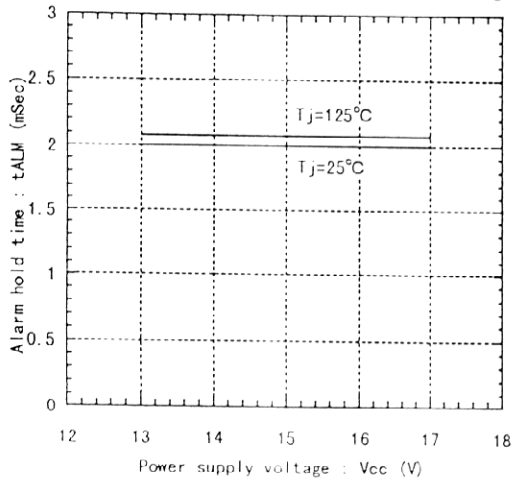

Over heating characteristics
TcOH, TjOH, TcH, TjH vs. Vcc

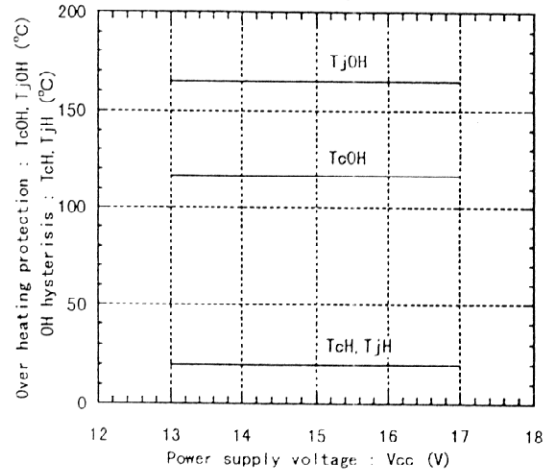

This material and the information herein is the property of Fuji Electric Co., Ltd. They shall be neither reproduced, copied, lent, or disclosed in any way whatsoever for the use of any third party, nor used for the manufacturing purposes without the express written consent of Fuji Electric Co., Ltd.

14-2. Inverter インバータ部

Collector current vs. Collector-Emitter voltage
Tj=25°C

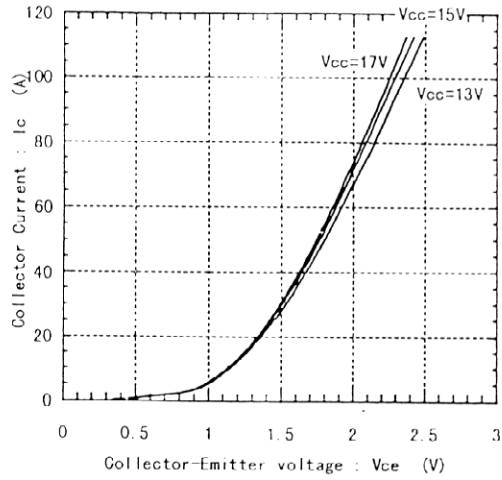

Collector current vs. Collector-Emitter voltage
Tj=125°C

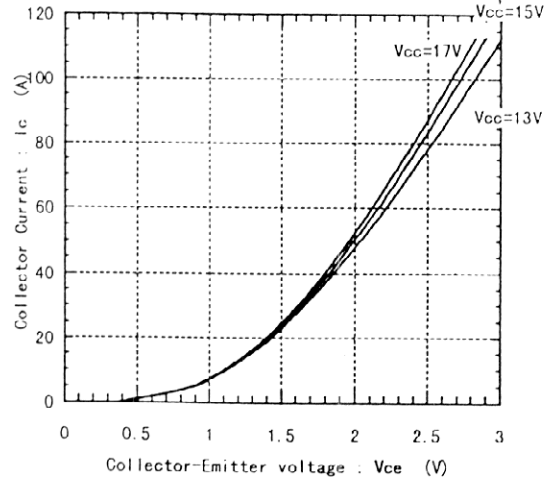

Switching time vs. Collector current
Edc=600V, Vcc=15V, Tj=25°C

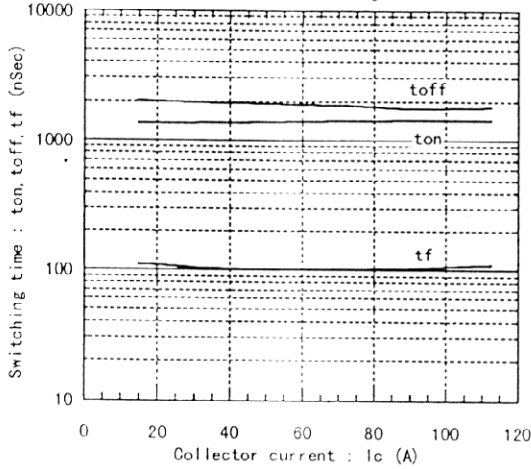

Switching time vs. Collector current
Edc=600V, Vcc=15V, Tj=125°C

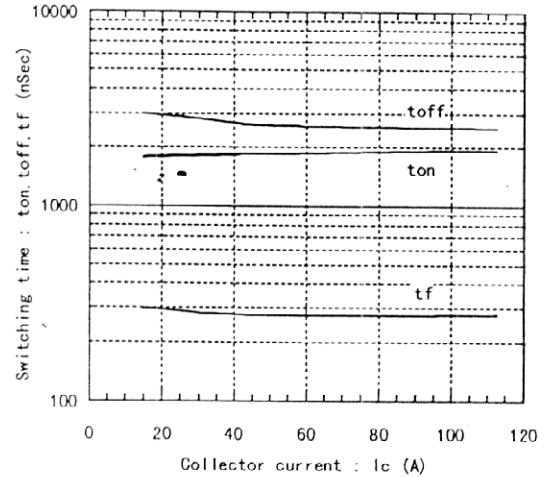

Forward current vs. Forward voltage

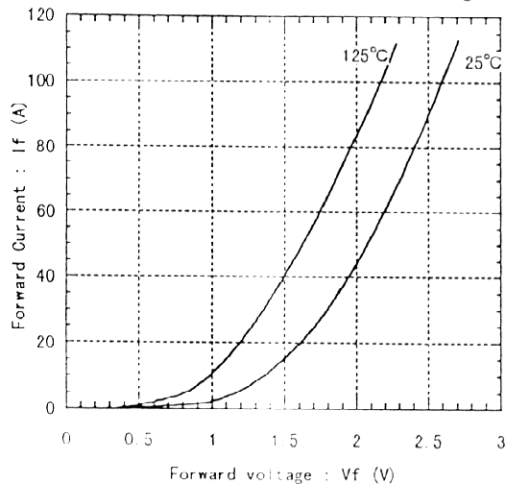

Reverse recovery characteristics
trr, Irr vs. IF

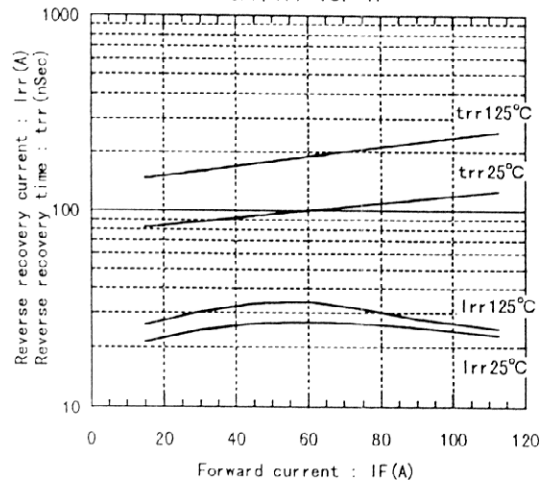

This material and the information herein is the property of Fuji Electric Co. Ltd. It shall be neither reproduced, copied, lent, or disclosed in any way whatsoever for the use of any third party, nor used for the manufacturing purposes without the express written consent of Fuji Electric Co. Ltd.

This material and the information herein is the property of Fuji Electric Co., Ltd. They shall be neither reproduced, copied, lent, or disclosed in any way whatsoever for the use of any third party, nor used for the manufacturing purposes without the express written consent of Fuji Electric Co., Ltd.

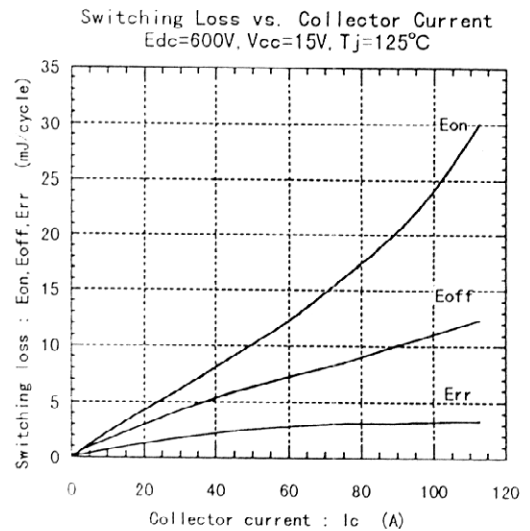
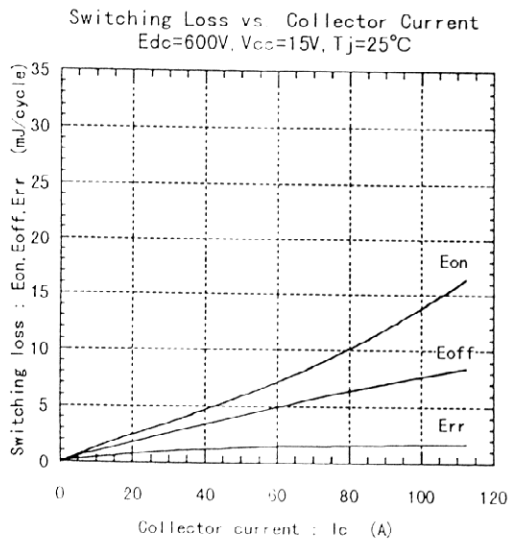
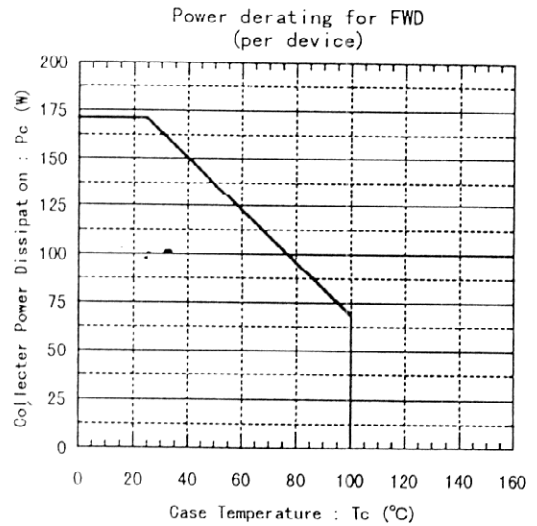
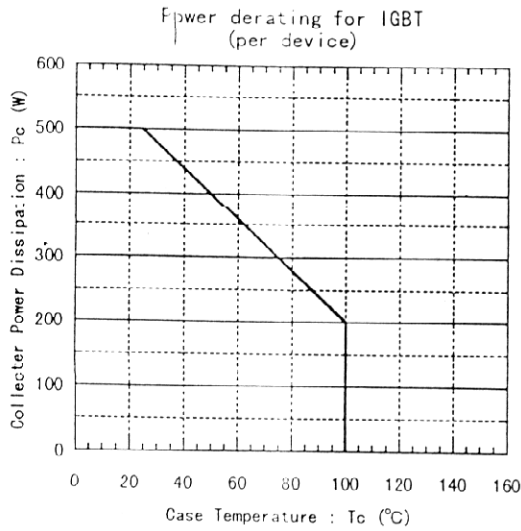
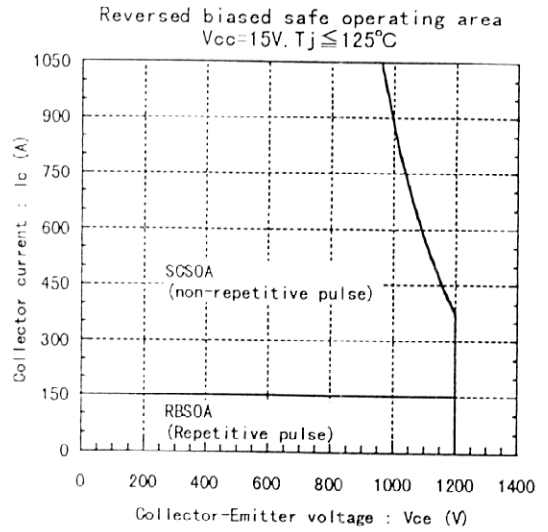
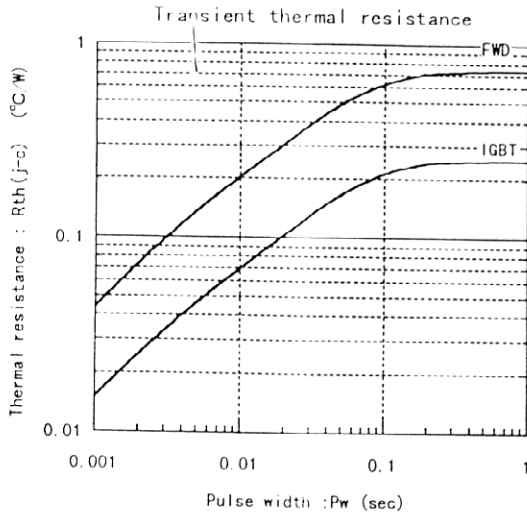

Over current protection vs. Junction temperature
 $V_{CC}=15V$

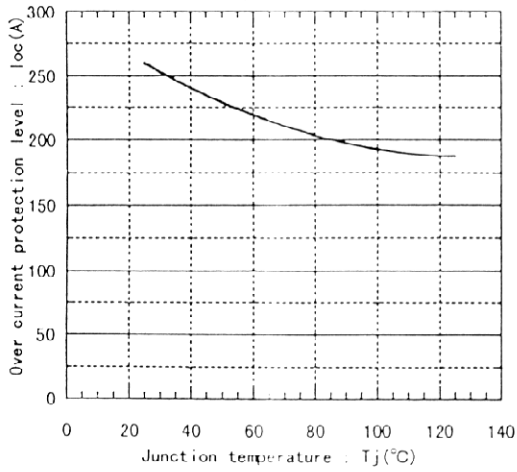

This material and the information herein is the property of Fuji Electric Co., Ltd. They shall be neither reproduced, copied, lent, or disclosed in any way whatsoever for the use of any third party nor used for the manufacturing purposes without the express written consent of Fuji Electric Co., Ltd.

ブレーキ部

Collector current vs. Collector-Emittor voltage
T_j=25°C

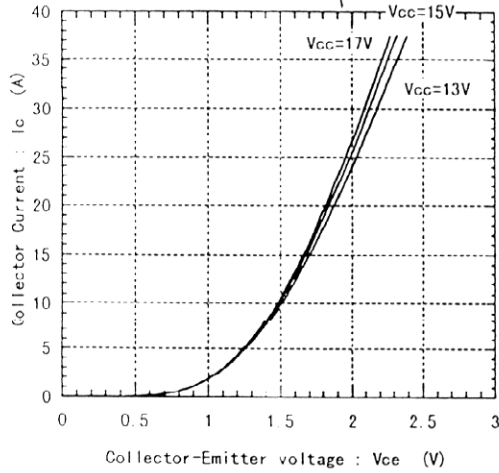

Collector current vs. Collector-Emittor voltage
T_j=125°C

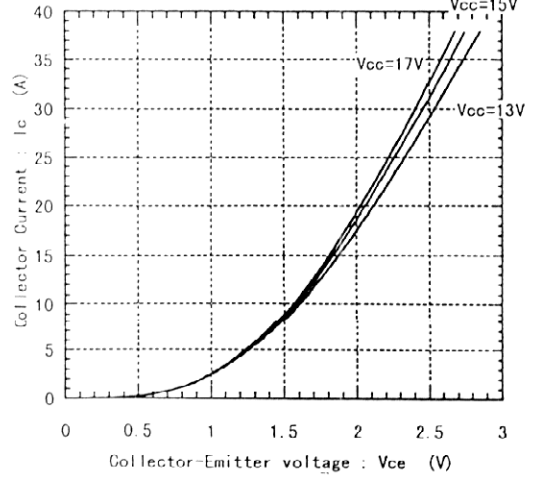

Transient thermal resistance

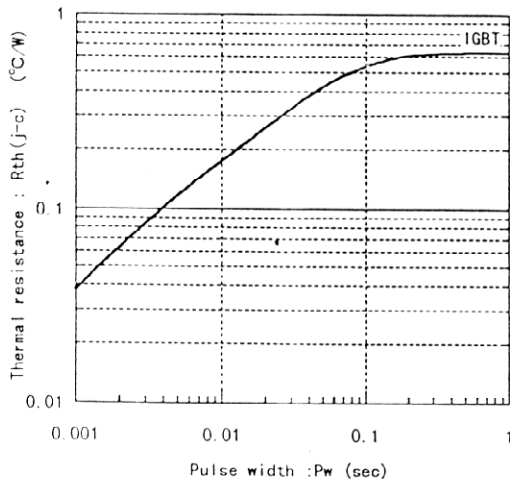

Reversed biased safe operating area
V_{cc}=15V, T_j ≤ 125°C

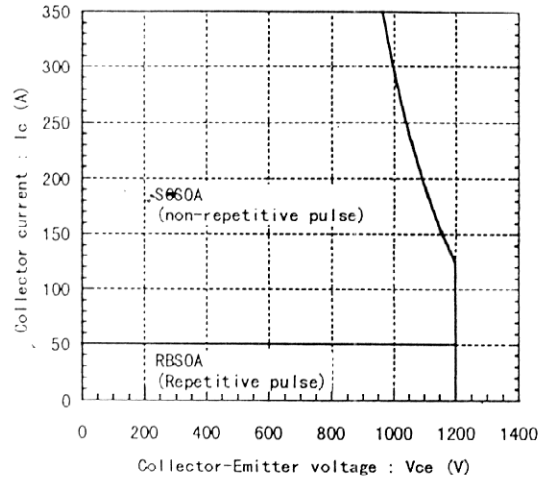

Power derating for IGBT
(per device)

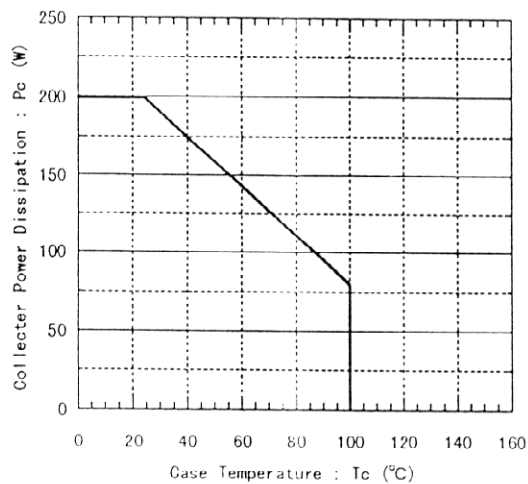

Over current protection vs. Junction temperature
V_{cc}=15V

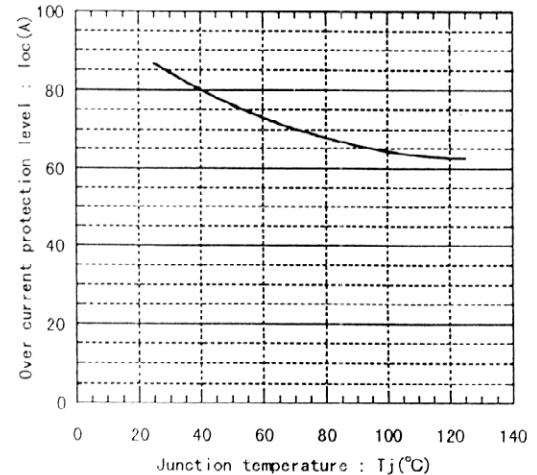

This material and the information herein is the property of Fuji Electric Co., Ltd. They shall be neither reproduced, copied, lent, or disclosed in any way whatsoever for the use of any third party, nor used for the manufacturing purposes without the express written consent of Fuji Electric Co., Ltd.

15. Example of applied circuit

応用回路例

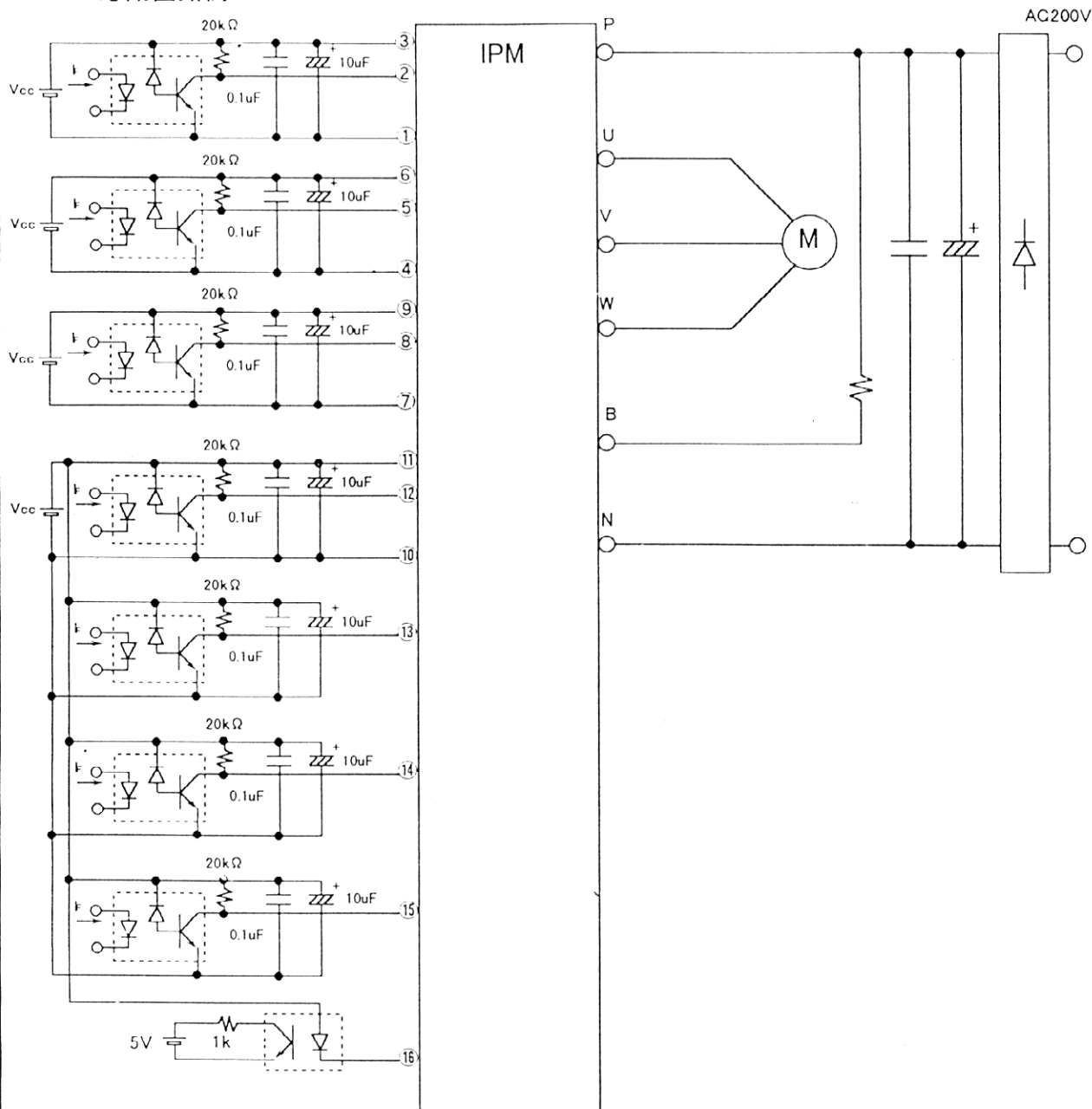

This material and the information herein is the property of Fuji Electric Co., Ltd. They shall be neither reproduced, copied, lent, or disclosed in any way whatsoever for the use of any third party nor used for the manufacturing purposes without the express written consent of Fuji Electric Co., Ltd.

- The wiring between opto-coupler and input terminals of IPM should be shorter as much as possible. The stray-capacitance between primary and secondary side of opto-coupler should not be increased by a pattern lay-out.

フォトカプラとIPMの入力端子間配線はできるだけ短くし、フォトカプラの1次・2次間の浮遊容量を増加させないパターンレイアウトとして下さい。

- Capacitor should be installed to Vcc-GND terminal of high-speed opto-coupler closely as much as possible.

高速フォトカプラのVcc-GND間には、コンデンサをできるだけ近接して取り付けして下さい。

- Use high-speed opto-coupler : $t_{PHL}, t_{PLH} \leq 0.8 \mu S$, high CMR type. (Example: HCPL-4504)

高速フォトカプラ: $t_{PHL}, t_{PLH} \leq 0.8 \mu S$, 高CMRタイプをご使用下さい。(例: HCPL-4504)

- Use Low-speed opto-coupler for alarm output : $CTR \geq 100\%$

アラーム出力用の低速フォトカプラ: $CTR \geq 100\%$ タイプをご使用下さい。

This material and the information herein is the property of Fuji Electric Co., Ltd. They shall be neither reproduced, copied, lent, or disclosed in any way whatsoever for the use of any third party nor used for the manufacturing purposes without the express written consent of Fuji Electric Co., Ltd.

- Each power supply for drive circuit should not have transient voltage fluctuation.
Four power supplies which are isolated should be supplied individually.
各制御用電源は瞬時電圧変動の少ない、絶縁されたものを4個独立に使用して下さい。
- The DC bus lines to the P-N terminals should have lower inductance as much as possible, such as connecting capacitor to P-N terminals, in order to reduce surge voltage.
P-N間の直流母線はできるだけ低インダクタンス化し、P-N端子間にコンデンサを接続するなどしてサージ電圧を低減して下さい。
- In order to avoid noise from AC line, connect capacitor (about 4.7nF) between three-phase line and earth.
ACラインからのノイズの侵入を防ぐため、3相各線-大地間に4.7nF程度のコンデンサを接続して下さい。
- Do not connect N-terminal of main circuit to ground (GND) of input circuit.
入力回路のグランド(GND)と主回路N端子を接続しないで下さい。
- In case of using connector for connection to control terminal, it must be Au-plated electrode and 2.54mm of pitch.
制御端子との接続にコネクタを用いる場合は、金メッキ電極・2.54mmピッチのものをご使用下さい。
- When capacitors are connected between input and GND terminals, pay attention to longer delay time after signals inputted to primary side of opto-coupler.
入力端子-GND間にコンデンサを接続するとフォトカップラ1次側入力信号に対する応答時間が長くなりますのでご注意下さい。