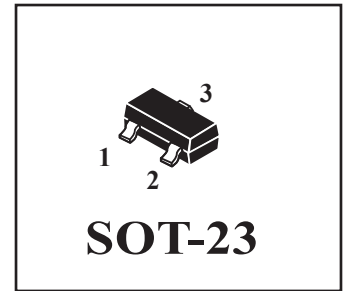
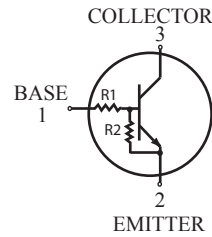


### Bias Resistor Transistor NPN Silicon

**(Pb)** Lead(Pb)-Free



### MAXIMUM RATINGS

Rating	Symbol	Value	Unit
Collector-Emitter Voltage	V <sub>CEO</sub>	50	V <sub>dc</sub>
Collector-Base Voltage	V <sub>CB0</sub>	50	V <sub>dc</sub>
Collector Current-Continuous	I <sub>C</sub>	100	mA <sub>dc</sub>

### THERMAL CHARACTERISTICS

Characteristics	Symbol	Value	Unit
Total Device Dissipation FR-5 Board (1) T <sub>A</sub> = 25°C Derate above 25°C	PD	246 1.6	mW mW / °C
Thermal Resistance, Junction to Ambient (1)	R <sub>θJA</sub>	625	°C/W
Junction and Storage, Temperature	T <sub>J</sub> , T <sub>stg</sub>	-65 to +150	°C

1. FR-4 @ minimum pad

### Device Marking and Resistor Values

Device	Marking	R1(k)	R2(k)	Device	Marking	R1(k)	R2(k)
MMUN2211	A8A	10	10	MMUN2232	A8J	4.7	4.7
MMUN2212	A8B	22	22	MMUN2233	A8K	4.7	47
MMUN2213	A8C	47	47	MMUN2234	A8L	22	47
MMUN2214	A8D	10	47	MMUN2235	A8M	2.2	47
MMUN2215	A8E	10	∞	MMUN2238	A8R	2.2	∞
MMUN2216	A8F	4.7	∞	MMUN2241	A8U	100	∞
MMUN2230	A8G	1.0	1.0				
MMUN2231	A8H	2.2	2.2				

**ELECTRICAL CHARACTERISTICS** ( $T_A = 25^\circ\text{C}$  unless otherwise noted)

Characteristic	Symbol	Min	Typ	Max	Unit
<b>OFF CHARACTERISTICS</b>					
Collector-Base Cutoff Current ( $V_{CB} = 50\text{ V}, I_E = 0$ )	$I_{CBO}$	-	-	100	nAdc
Collector-Emitter Cutoff Current ( $V_{CE} = 50\text{ V}, I_B = 0$ )	$I_{CEO}$	-	-	500	nAdc
Emitter-Base Cutoff Current ( $V_{EB} = 6.0\text{ V}, I_C = 0$ )	$I_{EBO}$	-	-	0.5	mAdc
MMUN2211		-	-	0.2	
MMUN2212		-	-	0.1	
MMUN2213		-	-	0.2	
MMUN2214		-	-	0.9	
MMUN2215		-	-	1.9	
MMUN2216		-	-	4.3	
MMUN2230		-	-	2.3	
MMUN2231		-	-	1.5	
MMUN2232		-	-	0.18	
MMUN2233		-	-	0.13	
MMUN2234		-	-	0.2	
MMUN2235		-	-	4.0	
MMUN2238		-	-	0.1	
MMUN2241		-	-		
Collector-Base Breakdown Voltage ( $I_C = 10\text{ mA}, I_E = 0$ )	$V_{(BR)CBO}$	50	-	-	Vdc
Collector-Emitter Breakdown Voltage (Note 2.) ( $I_C = 2.0\text{ mA}, I_B = 0$ )	$V_{(BR)CEO}$	50	-	-	Vdc

**ON CHARACTERISTICS** (Note 2.)

DC Current Gain ( $V_{CE} = 10\text{ V}, I_C = 5.0\text{ mA}$ )	$h_{FE}$	35	60	-	
MMUN2211		60	100	-	
MMUN2212		80	140	-	
MMUN2213		80	140	-	
MMUN2214		160	350	-	
MMUN2215		160	350	-	
MMUN2216		3.0	5.0	-	
MMUN2230		8.0	15	-	
MMUN2231		15	30	-	
MMUN2232		80	200	-	
MMUN2233		80	150	-	
MMUN2234		80	140	-	
MMUN2235		160	350	-	
MMUN2238		160	350	-	
MMUN2241					
Collector-Emitter Saturation Voltage ( $I_C = 10\text{ mA}, I_B = 0.3\text{ mA}$ ) ( $I_C = 10\text{ mA}, I_B = 5\text{ mA}$ ) MMUN2230/MMUN2231 ( $I_C = 10\text{ mA}, I_B = 1\text{ mA}$ ) MMUN2215/MMUN2216/MMUN2232 MMUN2233/MMUN2234/MMUN2235/MMUN2238	$V_{CE(sat)}$	-	-	0.25	Vdc
Output Voltage (on) ( $V_{CC} = 5.0\text{ V}, V_B = 2.5\text{ V}, R_L = 1.0\text{ k}\Omega$ )	$V_{OL}$	-	-	0.2	Vdc
MMUN2211		-	-	0.2	
MMUN2212		-	-	0.2	
MMUN2213		-	-	0.2	
MMUN2214		-	-	0.2	
MMUN2215		-	-	0.2	
MMUN2216		-	-	0.2	
MMUN2230		-	-	0.2	
MMUN2231		-	-	0.2	
MMUN2232		-	-	0.2	
MMUN2233		-	-	0.2	
MMUN2234		-	-	0.2	
MMUN2235		-	-	0.2	
( $V_{CC} = 5.0\text{ V}, V_B = 3.5\text{ V}, R_L = 1.0\text{ k}\Omega$ ) MMUN2238		-	-	0.2	
( $V_{CC} = 5.0\text{ V}, V_B = 5.0\text{ V}, R_L = 1.0\text{ k}\Omega$ ) MMUN2241		-	-	0.2	

2. Pulse Test: Pulse Width &lt; 300 ms, Duty Cycle &lt; 2.0 %.

## ELECTRICAL CHARACTERISTICS (T<sub>A</sub> = 25°C unless otherwise noted) (Continued)

Characteristic	Symbol	Min	Typ	Max	Unit
<b>ON CHARACTERISTICS</b> (Note 2) (Continued)					
Output Voltage (off) (V <sub>CC</sub> = 5.0 V, V <sub>B</sub> = 0.5 V, R <sub>L</sub> = 1.0 kΩ) (V <sub>CC</sub> = 5.0 V, V <sub>B</sub> = 0.050 V, R <sub>L</sub> = 1.0 kΩ) MMUN2230 (V <sub>CC</sub> = 5.0 V, V <sub>B</sub> = 0.25 V, R <sub>L</sub> = 1.0 kΩ) MMUN2215 MMUN2216 MMUN2233 MMUN2238	V <sub>OH</sub>	4.9	-	-	V <sub>dc</sub>
Input Resistor  MMUN2211 MMUN2212 MMUN2213 MMUN2214 MMUN2215 MMUN2216 MMUN2230 MMUN2231 MMUN2232 MMUN2233 MMUN2234 MMUN2235 MMUN2238 MMUN2241	R <sub>I</sub>	7.0 15.4 32.9 7.0 7.0 3.3 0.7 1.5 3.3 3.3 15.4 1.54 1.54 70	10 22 47 10 10 4.7 1.0 2.2 4.7 4.7 22 2.2 2.2 100	13 28.6 61.1 13 13 6.1 1.3 2.9 6.1 6.1 28.6 2.86 2.86 100	kΩ
Resistor Ratio MMUN2211/MMUN2212/MMUN2213 MMUN2214 MMUN2215/MMUN2216/MMUN2238 MMUN2241 MMUN2230/MMUN2231/MMUN2232 MMUN2233 MMUN2234 MMUN2235	R <sub>1</sub> /R <sub>2</sub>	0.8 0.17 - - 0.8 0.055 0.38 0.038	1.0 0.21 - - 1.0 0.1 0.47 0.047	1.2 0.25 - - 1.2 0.185 0.56 0.056	

2. Pulse Test: Pulse Width < 300 μs, Duty Cycle < 2.0%

## TYPICAL ELECTRICAL CHARACTERISTICS MMUN2211

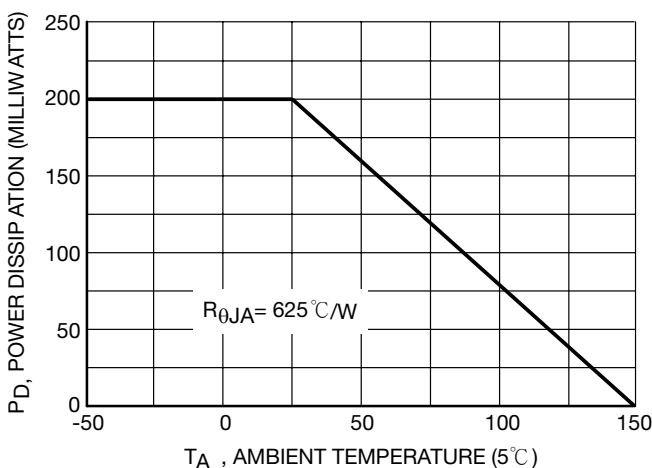


Figure 1. Derating Curve

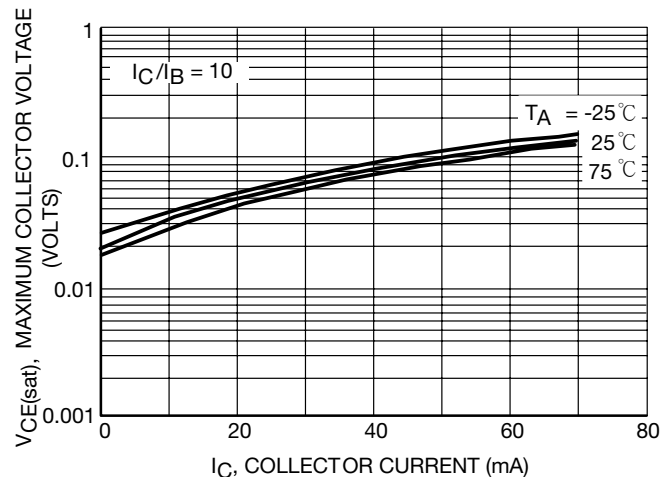


Figure 2. V<sub>CE(sat)</sub> vs. I<sub>C</sub>

TYPICAELECTRICAL CHARACTERISTICS

MMUN2212

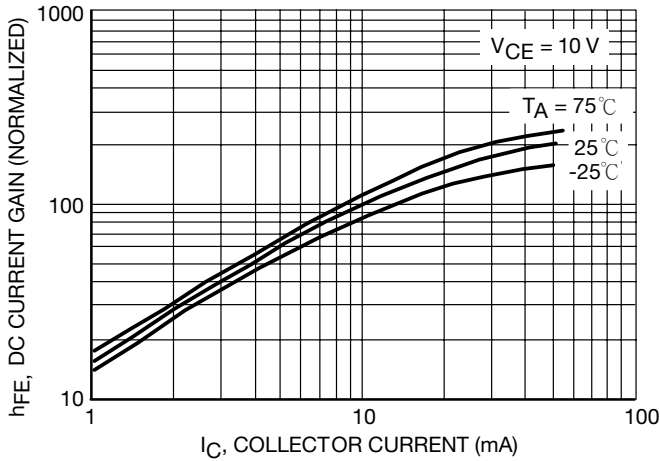


Figure 3. DC Current Gain

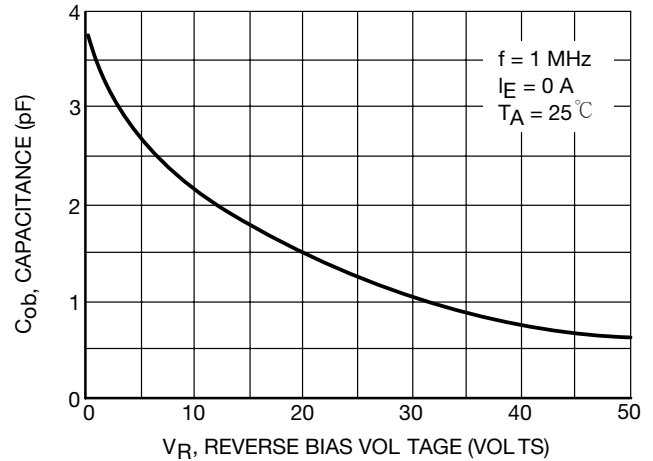


Figure 4. Output Capacitance

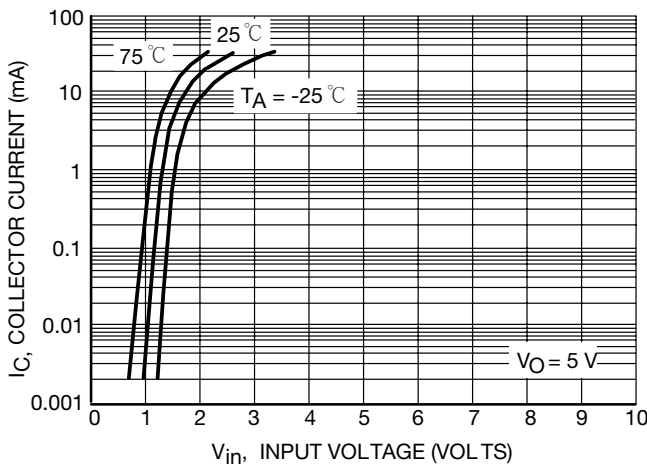


Figure 5. Output Current vs. Input Voltage

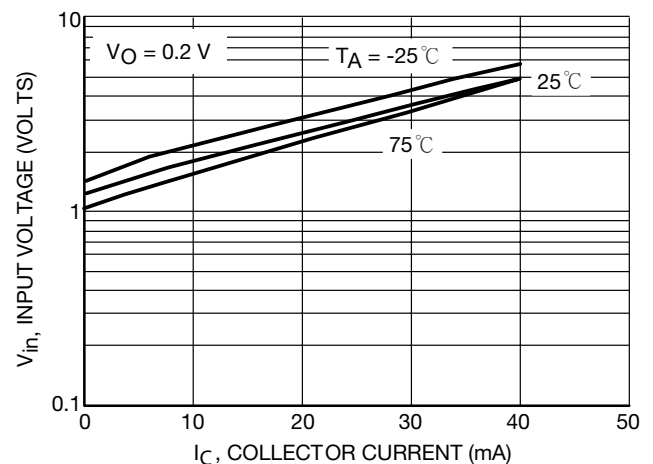


Figure 6. Input Voltage vs. Output Current

MMUN2211

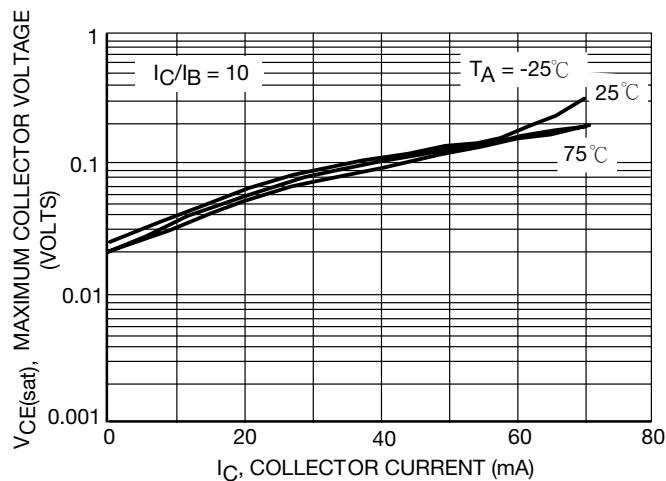


Figure 7. VCE(sat) vs. IC

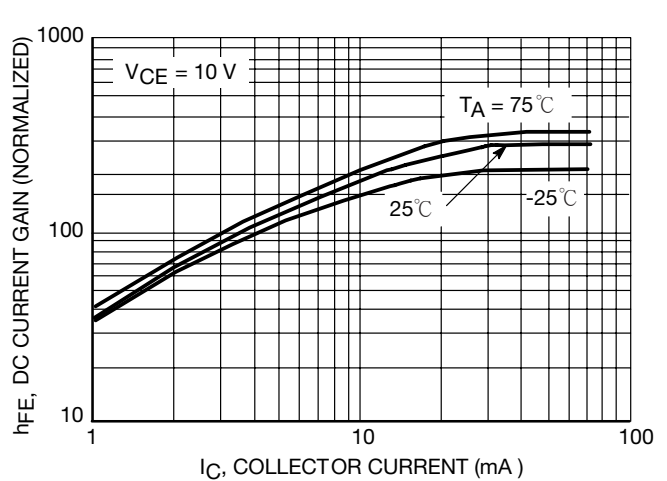


Figure 8. DC Current Gain

TYPICAL ELECTRICAL CHARACTERISTICS  
MMUN2212

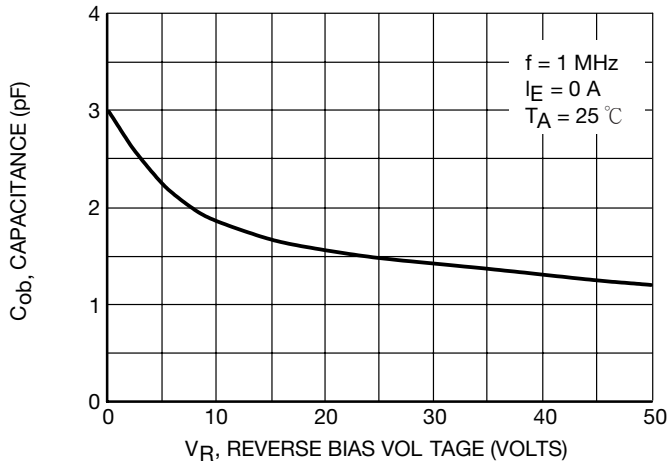


Figure 9. Output Capacitance

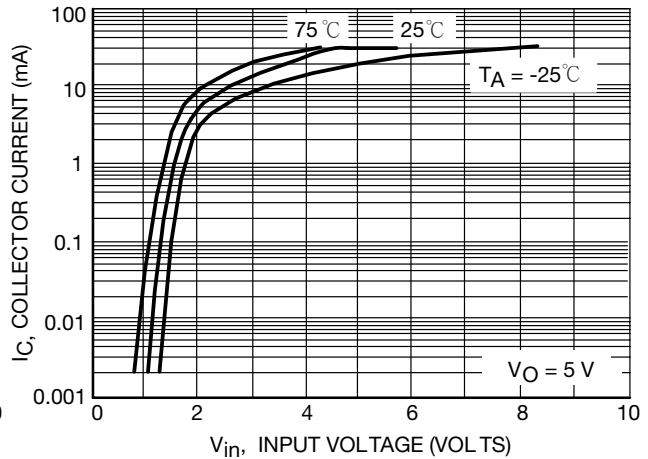


Figure 10. Output Current vs. Input Voltage

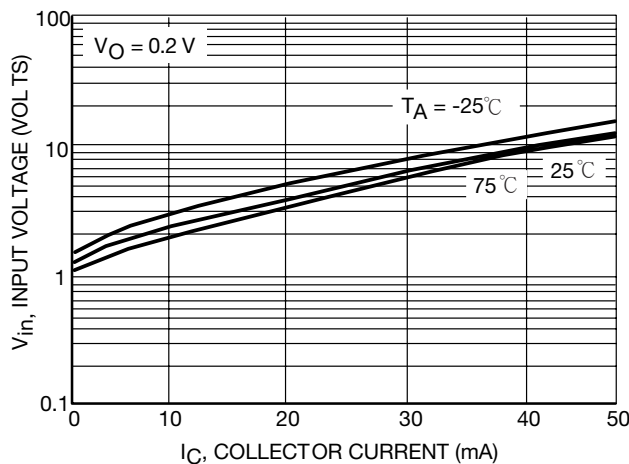


Figure 11. Input Voltage vs. Output Current

MMUN2213

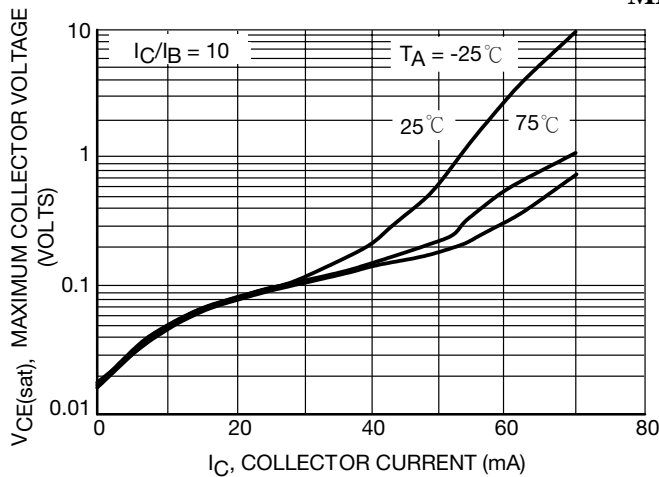


Figure 12.  $V_{CE(sat)}$  vs.  $I_C$

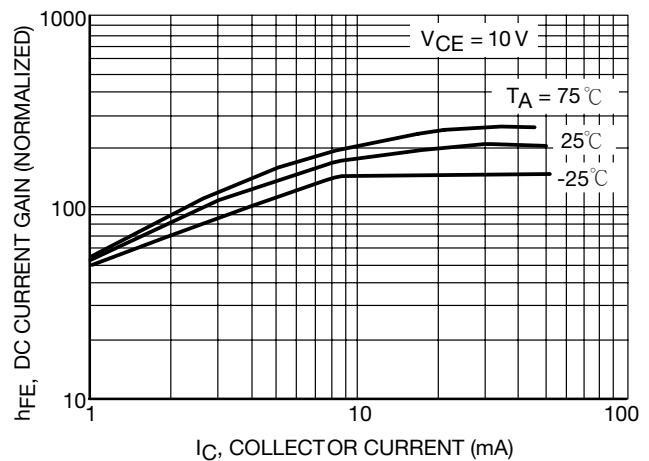


Figure 13. DC Current Gain

TYPICAL ELECTRICAL CHARACTERISTICS  
MMUN2213

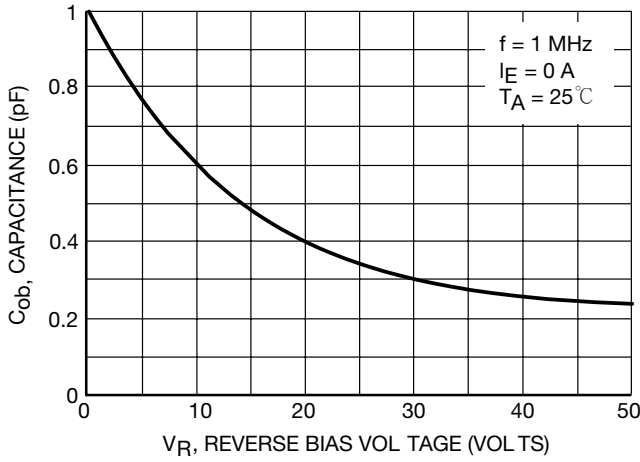


Figure 14. Output Capacitance

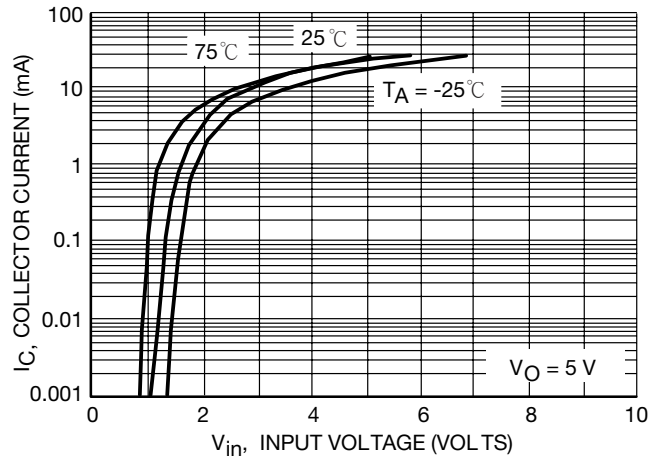


Figure 15. Output Current vs. Input Voltage

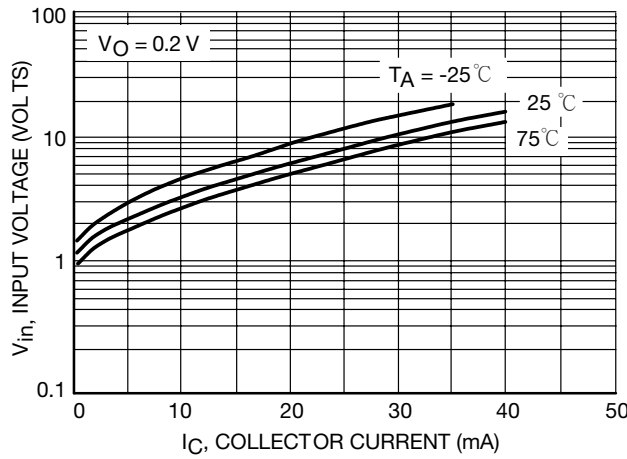


Figure 16. Input Voltage vs. Output Current

MMUN2214

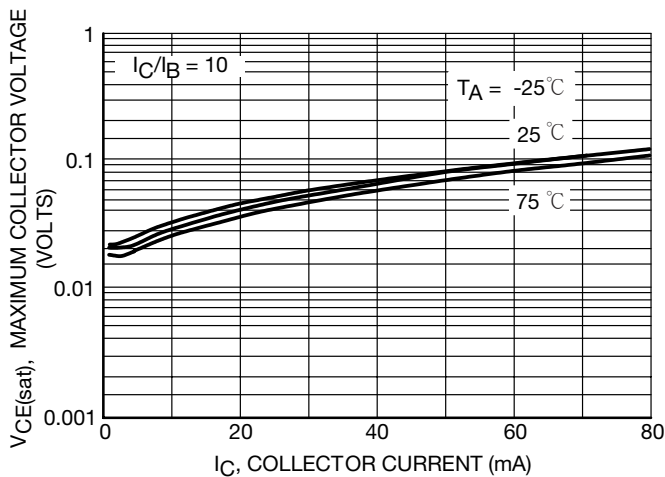


Figure 17.  $V_{CE(sat)}$  vs.  $I_C$

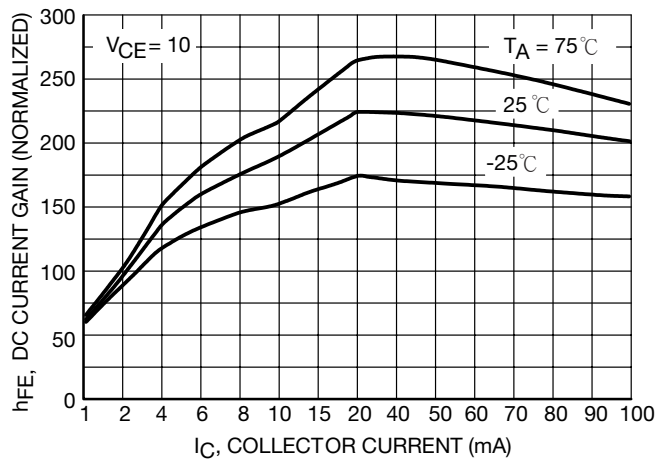


Figure 18. DC Current Gain

TYPICAL ELECTRICAL CHARACTERISTICS  
MMUN2214

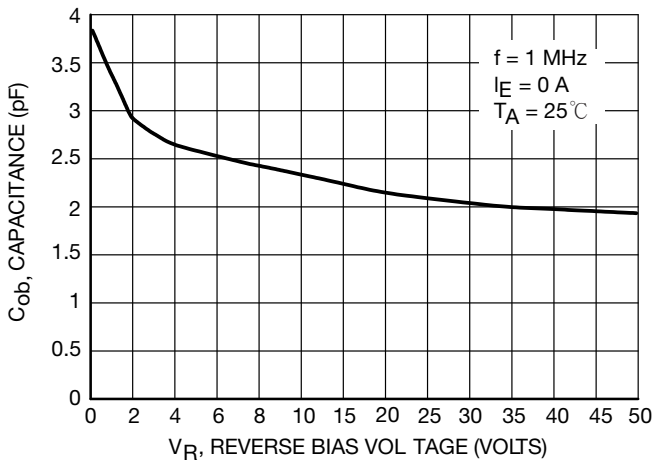


Figure 19. Output Capacitance

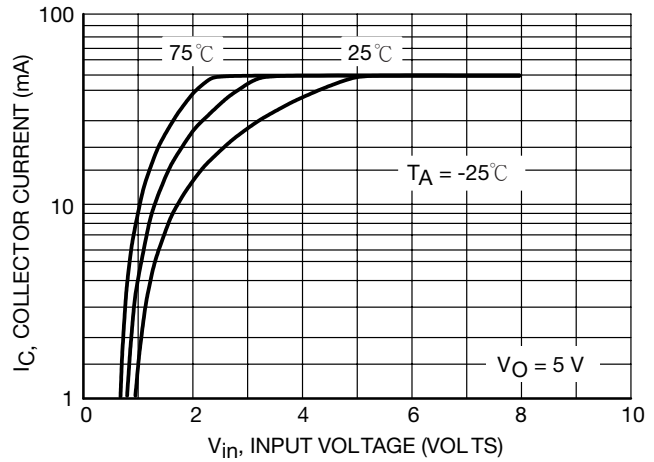


Figure 20. Output Current vs. Input Voltage

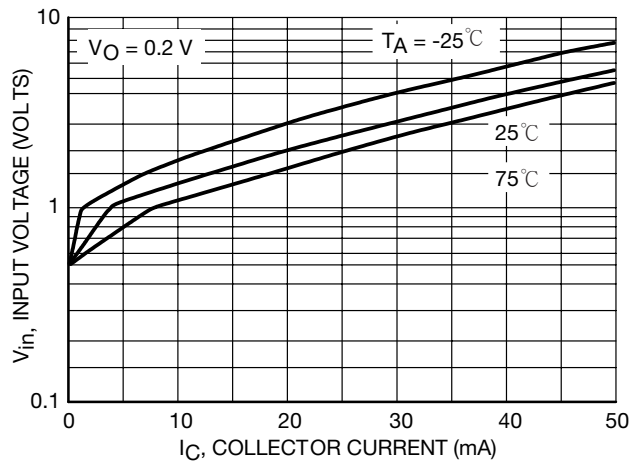


Figure 21. Input Voltage vs. Output Current

MMUN2232

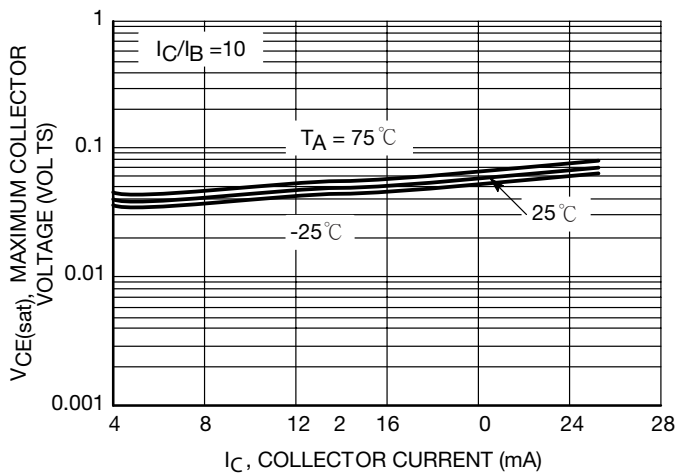


Figure 22.  $V_{CE(sat)}$  vs.  $I_C$

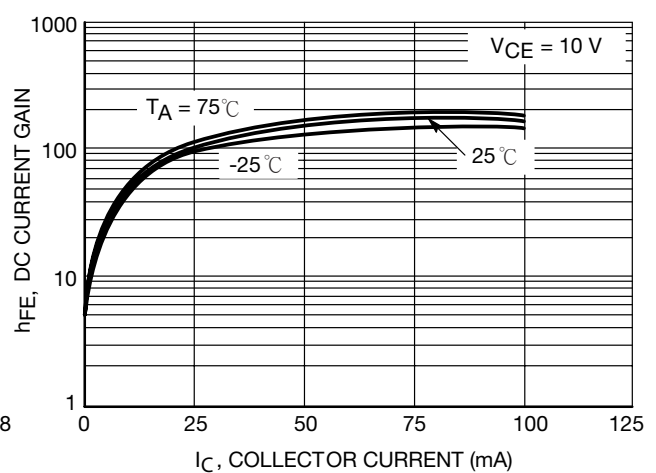


Figure 23. DC Current Gain

TYPICAL ELECTRICAL CHARACTERISTICS

MMUN2232

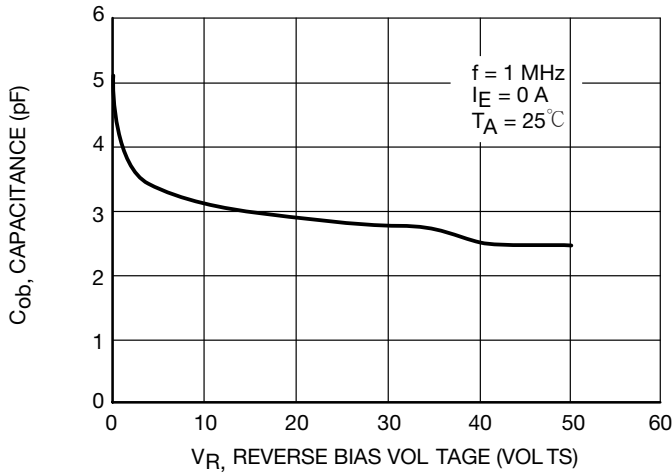


Figure 24. Output Capacitance

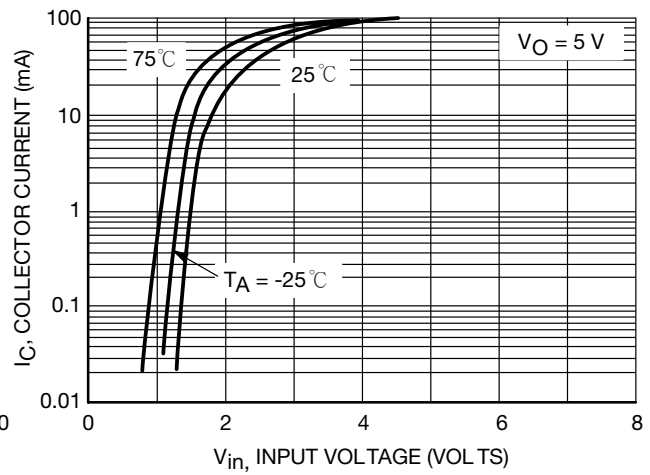


Figure 25. Output Current vs. Input Voltage

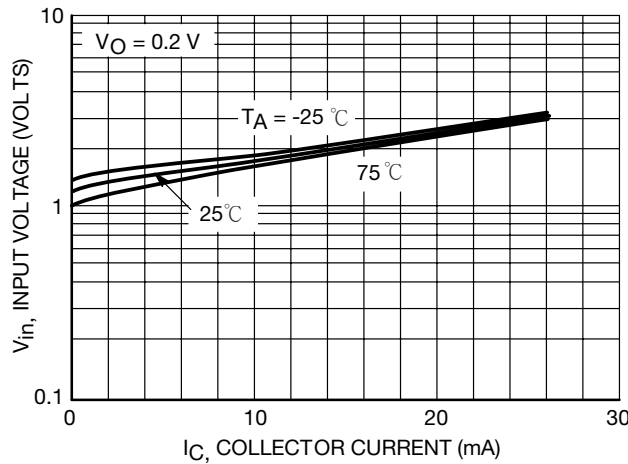


Figure 26. Output Voltage vs. Input Current

MMUN2233

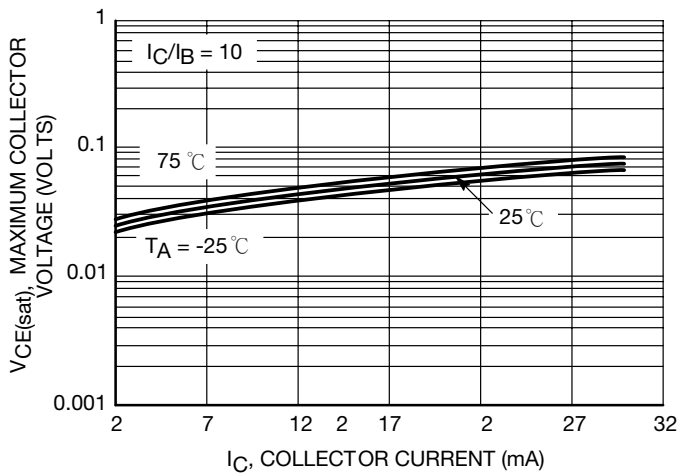


Figure 27. VCE(sat) vs. IC

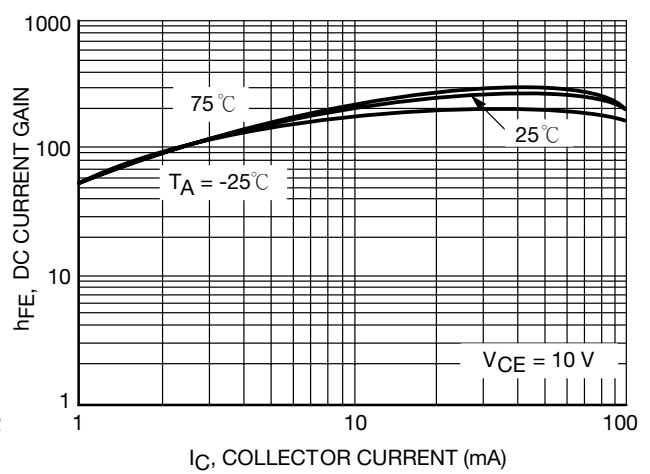
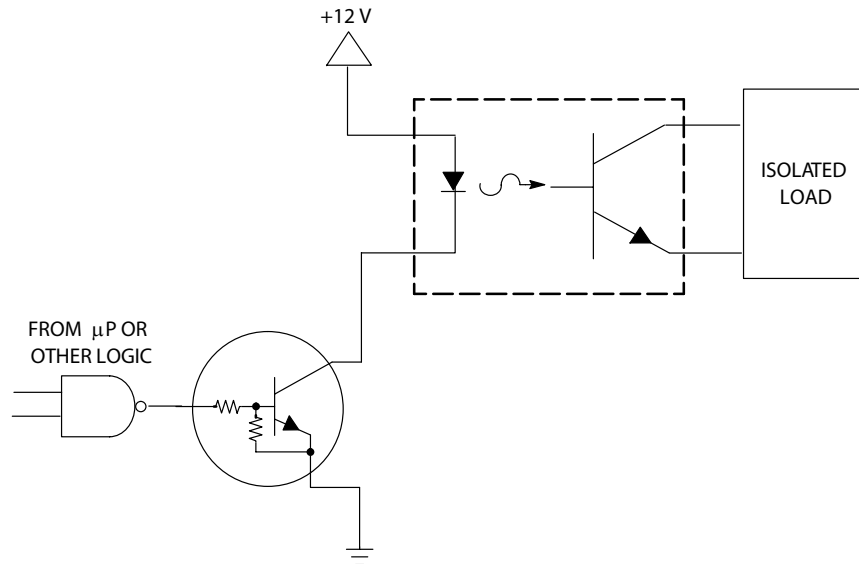


Figure 28. DC Current Gain

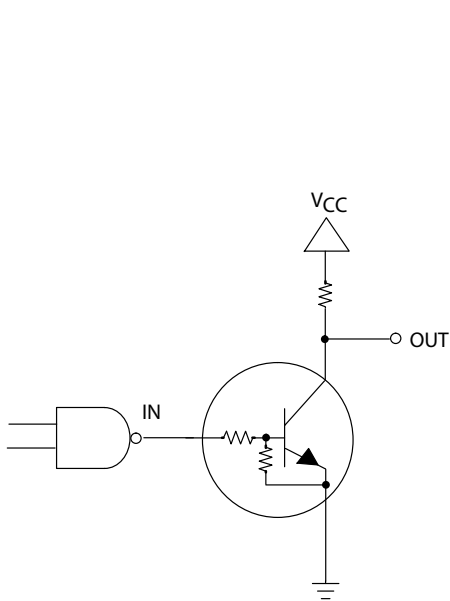


**MMUN2211 Series**

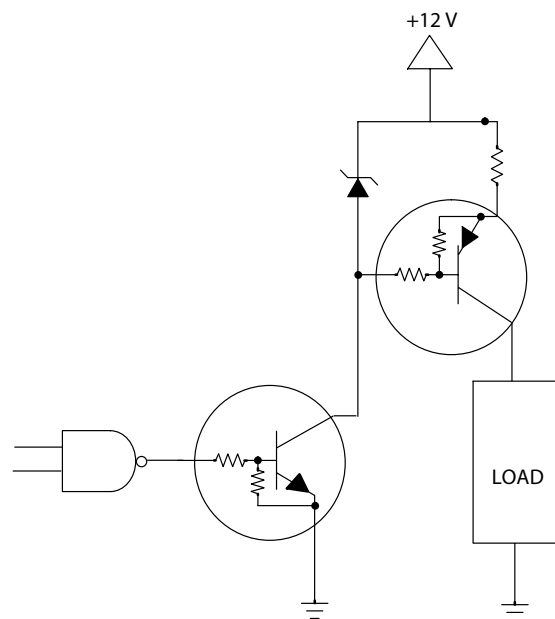
**TYPICAL APPLICATIONS FOR NPN BJT's**



**Figure 32. Level Shifter: Connects 12 or 24 Volt Circuits to Logic**

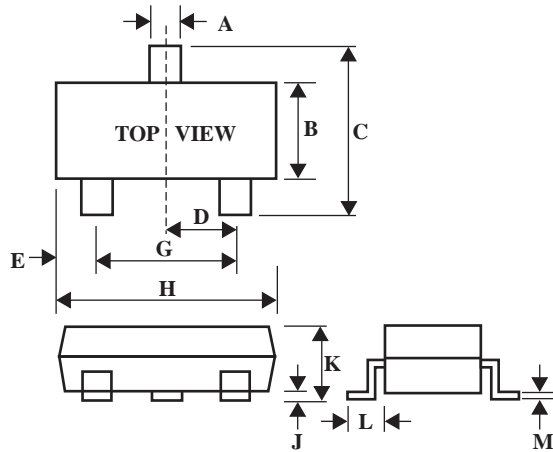


**Figure 33. Open Collector Inverter: Inverts the Input Signal**



**Figure 34. Inexpensive, Unregulated Current Source**

## SOT-23 Package Outline Dimension



SOT-23		
Dim	Min	Max
A	0.35	0.51
B	1.19	1.40
C	2.10	3.00
D	0.85	1.05
E	0.46	1.00
G	1.70	2.10
H	2.70	3.10
J	0.01	0.13
K	0.89	1.10
L	0.30	0.61
M	0.076	0.25