

**OBSOLETE PRODUCT  
NO RECOMMENDED REPLACEMENT**  
 contact our Technical Support Center at  
 1-888-INTERSIL or www.intersil.com/tsc

**Video Fader**



The EL4453 is a complete fader subsystem. It variably blends two inputs together for such applications as video picture-in-picture effects.

The EL4453 operates on  $\pm 5V$  to  $\pm 15V$  supplies and has an analog differential input range of  $\pm 2V$ . AC characteristics do not change appreciably over the supply range.

The circuit has an operational temperature of  $-40^{\circ}C$  to  $+85^{\circ}C$  and is packaged in 14-pin PDIP and SO-14.

The EL4453 is fabricated with Elantec's proprietary complementary bipolar process which gives excellent signal symmetry and is free from latch up.

**Pinout**

**EL4453  
(14-PIN PDIP, SO)  
TOP VIEW**

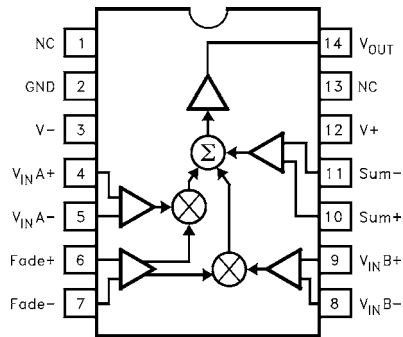

**Features**

- Complete two-input fader with output amplifier—uses no extra components
- 80MHz bandwidth
- Fast fade control speed
- Operates on  $\pm 5V$  to  $\pm 15V$  supplies
- > 60dB attenuation @ 5MHz

**Applications**

- Mixing two inputs
- Picture-in-picture
- Text overlay onto video
- General gain control

**Ordering Information**

PART NUMBER	TEMP. RANGE	PACKAGE	PKG. NO.
EL4453CN	$-40^{\circ}C$ to $+85^{\circ}C$	14-Pin PDIP	MDP0031
EL4453CS	$-40^{\circ}C$ to $+85^{\circ}C$	14-Pin SOIC	MDP0027

**Absolute Maximum Ratings** ( $T_A = 25^\circ\text{C}$ )

V+	Positive Supply Voltage	16.5V	I <sub>OUT</sub>	Output Current	30mA
V <sub>S</sub>	V+ to V- Supply Voltage	.33V	P <sub>D</sub>	Maximum Power Dissipation	See Curves
V <sub>IN</sub>	Voltage at any Input or Feedback	V+ to V-	T <sub>A</sub>	Operating Temperature Range	-40°C to +85°C
V <sub>IN</sub>	Difference between Pairs of Inputs or Feedback	.6V	T <sub>S</sub>	Storage Temperature Range	60°C to +150°C
ΔI <sub>IN</sub>	Current into any Input, or Feedback Pin	4mA			

CAUTION: Stresses above those listed in "Absolute Maximum Ratings" may cause permanent damage to the device. This is a stress only rating and operation of the device at these or any other conditions above those indicated in the operational sections of this specification is not implied.

IMPORTANT NOTE: All parameters having Min/Max specifications are guaranteed. Typical values are for information purposes only. Unless otherwise noted, all tests are at the specified temperature and are pulsed tests, therefore:  $T_J = T_C = T_A$

**Open-Loop DC Electrical Specifications** Power Supplies at ±5V, Sum+ = Sum- = 0,  $T_A = 25^\circ\text{C}$

PARAMETER	DESCRIPTION	MIN	TYP	MAX	UNITS	
V <sub>DIFF</sub>	V <sub>INA</sub> , V <sub>INB</sub> , or Sum Differential Input Voltage	Clipping	1.8	2.0		V
		0.2% Nonlinearity		0.7		V
V <sub>CM</sub>	Common-Mode Range (All Inputs; V <sub>DIFF</sub> = 0)	V <sub>S</sub> = ±5V	±2.5	±2.8		V
		V <sub>S</sub> = ±15V	±12.5	±12.8		V
V <sub>OS</sub>	A or B Input Offset Voltage			25	mV	
V <sub>FADE</sub> , 100%	Extrapolated Voltage for 100% Gain for V <sub>INA</sub>	0.9	1.05	1.2	V	
V <sub>FADE</sub> , 0%	Extrapolated Voltage for 0% Gain for V <sub>INA</sub>	-1.2	-1.15	-0.9	V	
I <sub>B</sub>	Input Bias Current (All Inputs) with all V <sub>IN</sub> = 0		9	20	μA	
I <sub>OS</sub>	Input Offset Current between V <sub>INA+</sub> and V <sub>INA-</sub> , V <sub>INB+</sub> and V <sub>INB-</sub> , Fade+ and Fade-, and Sum+ and Sum-		0.2	4	μA	
F <sub>T</sub>	V <sub>INA</sub> Signal Feedthrough, V <sub>FADE</sub> = -1.5V		-100	-60	dB	
NL	A or B Input Nonlinearity, V <sub>IN</sub> between +1V and -1V	V <sub>INA</sub> or V <sub>INB</sub>		0.2	0.5	%
		Sum Input		0.5		%
R <sub>IN</sub> , Signal	Input Resistance, A, B, or Sum Input		230		kΩ	
R <sub>IN</sub> , Fade	Input Resistance, Fade Input		120		kΩ	
CMRR	Common-Mode Rejection Ratio, V <sub>INA</sub> or V <sub>INB</sub>	70	80		dB	
PSRR	Power Supply Rejection Ratio	50	70		dB	
E <sub>G</sub>	Gain Error, V <sub>FADE</sub> = 1.5V	V <sub>INA</sub> or V <sub>INB</sub>	-2		+2	%
		Sum Input	-4		+4	%
V <sub>O</sub>	Output Voltage Swing (V <sub>IN</sub> = 0, V <sub>REF</sub> Varied)	V <sub>S</sub> = ±5V	±2.5	±2.8		V
		V <sub>S</sub> = ±15V	±12.5	±12.8		V
I <sub>SC</sub>	Output Short-Circuit Current	40	85		mA	
I <sub>S</sub>	Supply Current, V <sub>S</sub> = ±15V		17	21	mA	

**Open-Loop DC Electrical Specifications**

Power supplies at  $\pm 12V$ ,  $T_A = 25^\circ C$ ,  $R_L = 500\Omega$ ,  $C_L = 15pF$ ,  $V_{FADE} = 1.5V$ ,  $Sum+ = Sum- = 0$

PARAMETER	DESCRIPTION	MIN	TYP	MAX	UNITS
BW, -3dB	-3dB Small-Signal Bandwidth, $V_{INA}$ or $V_{INB}$		80		MHz
BW, $\pm 0.1dB$	0.1dB Flatness Bandwidth, $V_{INA}$ or $V_{INB}$		9		MHz
Peaking	Frequency Response Peaking		1.0		dB
BW, Fade	-3dB Small-Signal Bandwidth, Fade Input		80		MHz
SR	Slew Rate, $V_{OUT}$ between -2V and +2V	TBD	380		V/ $\mu s$
$V_N$	Input-Referred Noise Voltage Density		160		nV/Hz
$F_T$	Feedthrough of Faded-Out Channel, $F = 3.58MHz$		-63		dB
dG	Differential Gain Error, $V_{OFFSET}$ from 0 to $\pm 0.714V$ , Fade at 100%	$V_{INA}$ or $V_{INB}$	0.05		%
		Sum Input	0.35		%
d $\theta$	Differential Phase Error, $V_{OFFSET}$ from 0 to $\pm 0.71V$ , Fade at 100%	$V_{INA}$ or $V_{INB}$	0.05		( $^\circ$ )
		Sum Input	0.1		( $^\circ$ )

**Test Circuit**

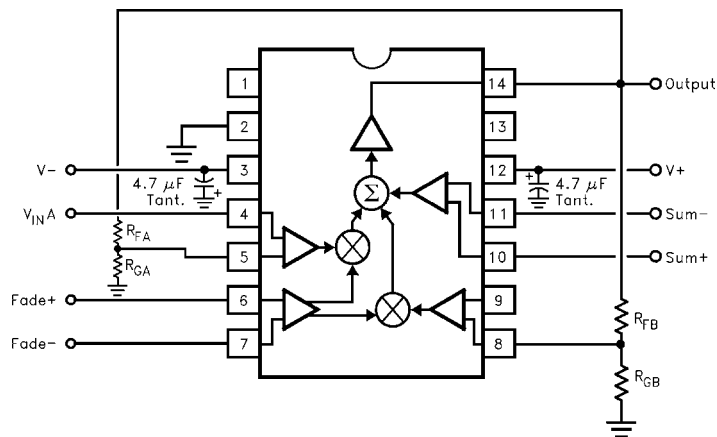

Note: For typical performance curves  $Sum+ = Sum- = 0$ ,  $R_F = 0\Omega$ ,  $R_G = \infty$ ,  $V_{FADE} = +1.5V$ , and  $C_L = 15pF$ , unless otherwise noted.

Typical Performance Curves

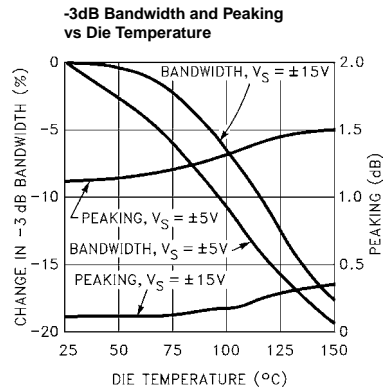
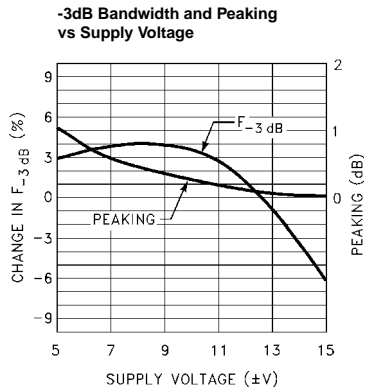
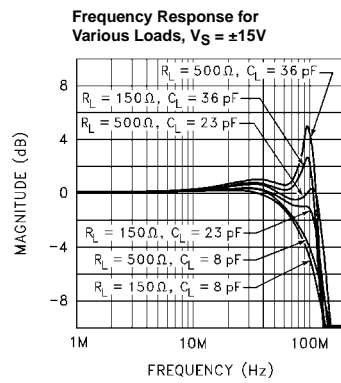
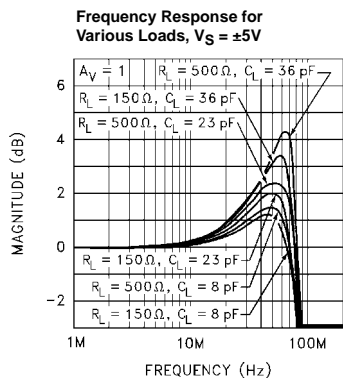
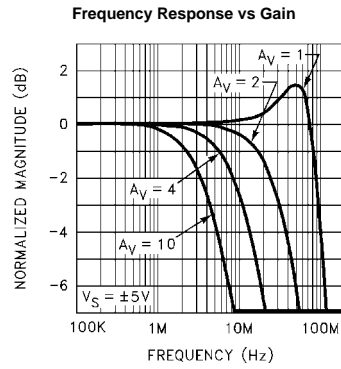
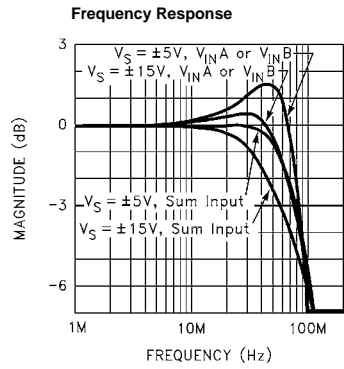

Typical Performance Curves (Continued)

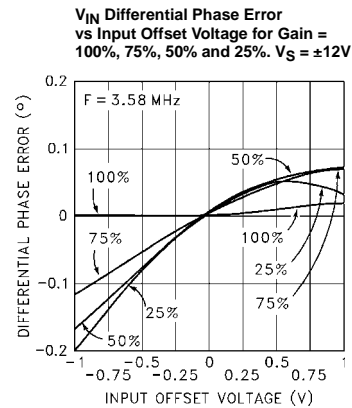
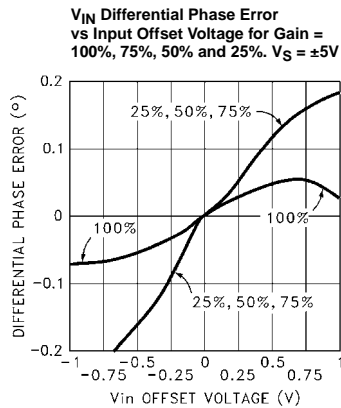
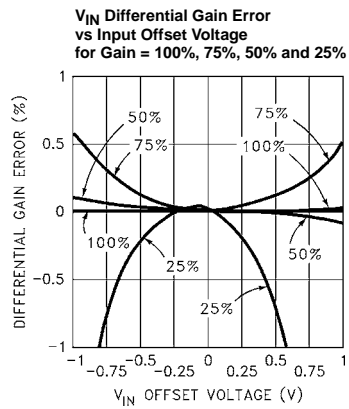
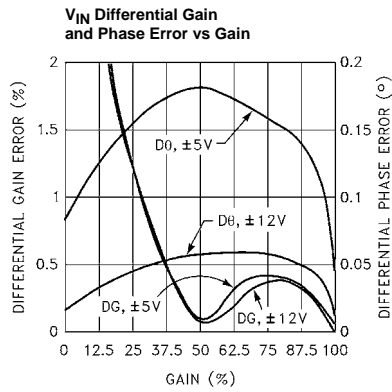
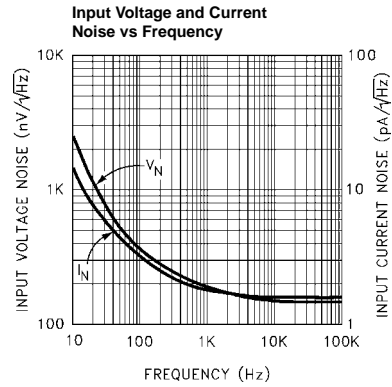
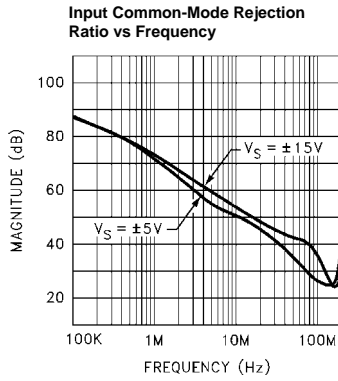
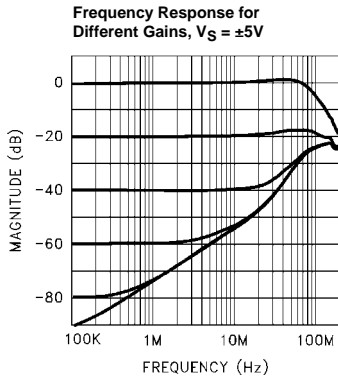

Typical Performance Curves (Continued)

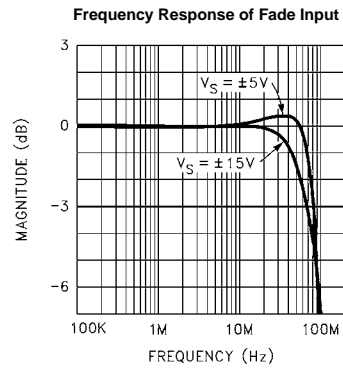
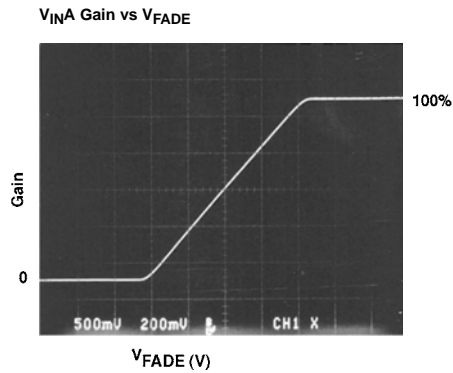
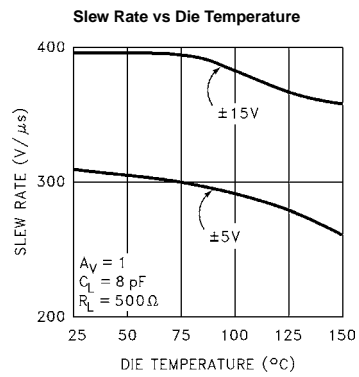
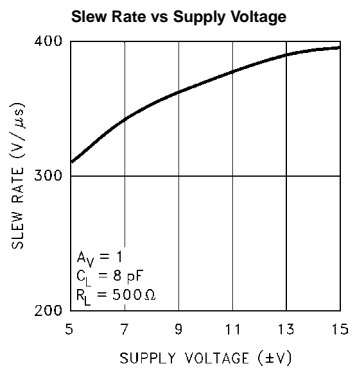
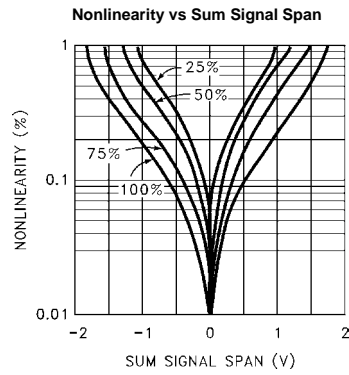
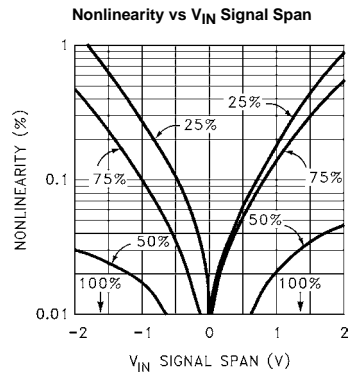

Typical Performance Curves (Continued)

Transient Response of Fade Input  
Constant Signal into  $V_{INA}$

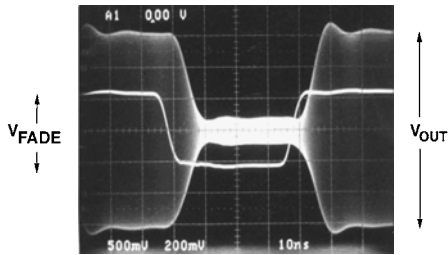

Overdrive Recovery Glitch from  
 $V_{FADE}$ , No Input Signal

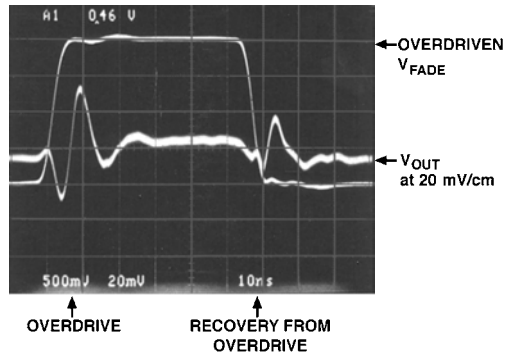

$V_{INA}$  Transient Response for Various Gains

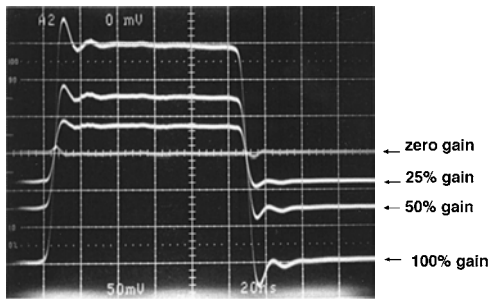

Cross-Fade Balance with  $V_{INA} = V_{INB} = 0$

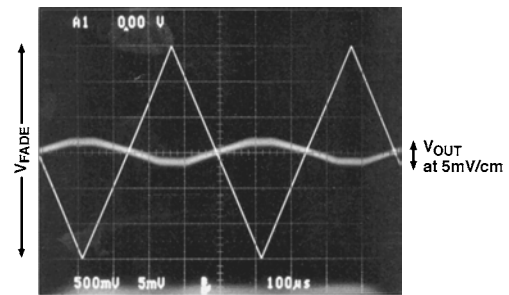

Supply Current vs Supply Voltage

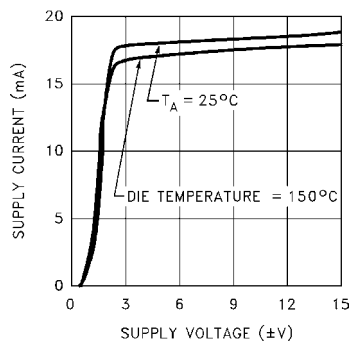

Supply Current vs Die Temperature

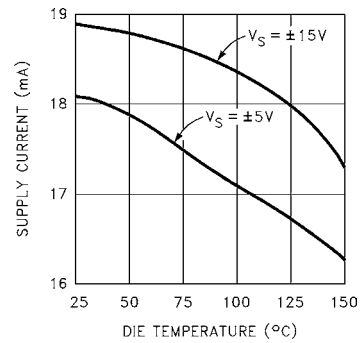

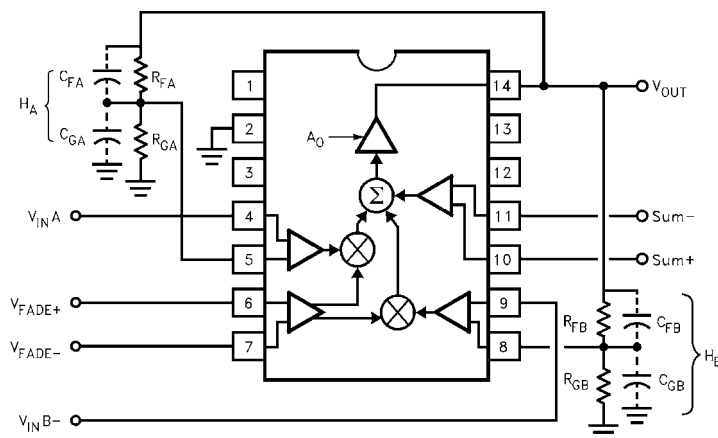

FIGURE 1.

### Applications Information

The EL4453 is a complete two-quadrant fader/gain control with 80MHz bandwidth. It has four sets of inputs; a differential signal input  $V_{IN A}$ , a differential signal input  $V_{IN B}$ , a differential fade-controlling input  $V_{FADE}$ , and another differential input Sum which can be used to add in a third input at full gain. This is the general connection of the EL4453 (Figure 1).

The gain of the feedback dividers are  $H_A$  and  $H_B$ , and  $0 \leq H \leq 1$ . The transfer function of the part is:

$$V_{OUT} = A_O \times [((V_{IN A+}) - H_A \times V_{OUT}) \times (1 + (V_{FADE+}) - (V_{FADE-})) / 2 + ((V_{IN B+}) - H_B \times V_{OUT}) \times (1 - (V_{FADE+}) + (V_{FADE-})) / 2 + (Sum+) - (Sum-)],$$

with  $-1 \leq (V_{FADE+}) - (V_{FADE-}) \leq +1$  numerically.

$A_O$  is the open-loop gain of the amplifier, and is about 600. The large value of  $A_O$  drives:

$$((V_{IN A+}) - H_A \times V_{OUT}) \times (1 + (V_{FADE+}) - (V_{FADE-})) / 2 + ((V_{IN B+}) - H_B \times V_{OUT}) \times (1 - (V_{FADE+}) + (V_{FADE-})) / 2 + (Sum+) - (Sum-) \rightarrow 0.$$

Rearranging and substituting:

$$V_{OUT} = \frac{F \times V_{IN A} + \bar{F} \times V_{IN B} + Sum}{F \times H_A + \bar{F} \times H_B}$$

$$\text{Where } F = (1 + (V_{FADE+}) - (V_{FADE-})) / 2$$

$$\bar{F} = (1 - (V_{FADE+}) + (V_{FADE-})) / 2$$

$$\text{and } Sum = (Sum+) - (Sum-)$$

In the above equations, F represents the fade amount, with  $F = 1$  giving 100% gain on  $V_{IN A}$  but 0% for  $V_{IN B}$ ;  $F = 0$  giving 0% gain for  $V_{IN A}$  but 100% to  $V_{IN B}$ .  $\bar{F}$  is  $1 - F$ , the complement of the fade gain. When  $F = 1$ ,

$$V_{OUT} = \frac{V_{IN A} + Sum}{H_A}$$

and the amplifier passes  $V_{IN A}$  and Sum with a gain of  $1/H_A$ . Similarly, for  $F = 0$ ,

$$V_{OUT} = \frac{V_{IN B} + Sum}{H_A}$$

and the gains vary linearly between fade extremes.

The EL4453 is stable for a direct connection between  $V_{OUT}$  and  $V_{IN A-}$  or  $V_{IN B-}$ , yielding a gain of +1. The feedback divider may be used for higher output gain, although with the traditional loss of bandwidth. It is important to keep the feedback divider's impedances low so that stray capacitance does not diminish the feedback loop's phase margin. The pole caused by the parallel impedance of the feedback resistors and stray capacitance should be at least 150MHz; typical strays of 3pF thus require a feedback impedance of 360Ω or less. Alternatively, a small capacitor across  $R_F$  can be used to create more of a frequency-compensated divider. The value of the capacitor should scale with the parasitic capacitance at the FB input. It is also practical to place small capacitors across both the feedback resistors (whose values maintain the desired gain) to swamp out parasitics. For instance, two 10pF capacitors across equal divider resistors for a gain of two will dominate parasitic effects and allow a higher divider resistance. Either input channel can be set up for inverting gain using traditional feedback resistor connections.

At 100% gain, an input stage operates just like an op-amp's input, and the gain error is very low, around -0.2%. Furthermore, nonlinearities are vastly improved since the gain core sees only small error signals, not full inputs. Unfortunately, distortions increase at lower fade gains for a given input channel.

The Sum pins can be used to inject an additional input signal, but it is not as linear as the  $V_{IN}$  paths. The gain error is also not as good as the main inputs, being about 1%. Both sum pins should be grounded if they are not to be used.



### Fade-Control Characteristics

The quantity  $V_{FADE}$  in the above equations is bounded as  $-1 \leq V_{FADE} \leq 1$ , even though the externally applied voltages often exceed this range. Actually, the gain transfer function around -1V and +1V is “soft”, that is, the gain does not clip abruptly below the 0%- $V_{FADE}$  voltage or above the 100%- $V_{FADE}$  level. An overdrive of 0.3V must be applied to  $V_{FADE}$  to obtain truly 0% or 100%. Because the 0% = or 100%- $V_{FADE}$  levels cannot be precisely determined, they are extrapolated from two points measured inside the slope of the gain transfer curve. Generally, an applied  $V_{FADE}$  range of -1.5V to +1.5V will assure the full span of numerical  $-1 \leq V_{FADE} \leq 1$  and  $0 \leq F \leq 1$ .

The fade control has a small-signal bandwidth equal to the  $V_{IN}$  channel bandwidth, and overload recovery resolves in about 20ns.

### Input Connections

The input transistors can be driven from resistive and capacitive sources, but are capable of oscillation when presented with an inductive input. It takes about 80nH of series inductance to make the inputs actually oscillate, equivalent to four inches of unshielded wiring or about six inches of unterminated input transmission line. The oscillation has a characteristic frequency of 500MHz. Often placing one's finger (via a metal probe) or an oscilloscope probe on the input will kill the oscillation. Normal high frequency construction obviates any such problems, where the input source is reasonably close to the fader input. If this is not possible, one can insert series resistors of around 51 $\Omega$  to de-Q the inputs.

### Signal Amplitudes

Signal input common-mode voltage must be between (V-) + 2.5V and (V+) - 2.5V to ensure linearity. Additionally, the differential voltage on any input stage must be limited to  $\pm 6V$  to prevent damage. The differential signal range is  $\pm 2V$  in the EL4453. The input range is substantially constant with temperature.

### The Ground Pin

The ground pin draws only 6 $\mu A$  maximum DC current, and may be biased anywhere between (V-) +2.5V and (V+) - 3.5V. The ground pin is connected to the IC's substrate and frequency compensation components. It serves as a shield within the IC and enhances input stage CMRR and channel-to-channel isolation over frequency, and if connected to a potential other than ground, it must be bypassed.

### Power Supplies

The EL4453 works well on any supplies from  $\pm 3V$  to  $\pm 15V$ . The supplies may be of different voltages as long as the requirements of the GND pin are observed (see the Ground Pin section for a discussion). The supplies should be bypassed close to the device with short leads. 4.7 $\mu F$

tantalum capacitors are very good, and no smaller bypasses need be placed in parallel. Capacitors as small as 0.01 $\mu F$  can be used if small load currents flow.

Singe-polarity supplies, such as +12V with +5V can be used, where the ground pin is connected to +5V and V- to ground. The inputs and outputs will have to have their levels shifted above ground to accommodate the lack of negative supply.

The dissipation of the fader increases with power supply voltage, and this must be compatible with the package chosen. This is a close estimate for the dissipation of a circuit:

$$P_D = 2 \times V_S, \max \times V_S + (V_S - V_O) \times V_O / R_{PAR}$$

where

$I_S, \max$  is the maximum supply current

$V_S$  is the  $\pm$  supply voltage (assumed equal)

$V_O$  is the output voltage

$R_{PAR}$  is the parallel of all resistors loading the output

For instance, the EL4453 draws a maximum of 21 mA. With light loading,  $R_{PAR} \rightarrow \infty$  and the dissipation with  $\pm 5V$  supplies is 210mW. The maximum supply voltage that the device can run on for a given  $P_D$  and the other parameters is:

$$V_S, \max = (P_D + V_O^2 / R_{PAR}) / (2I_S + V_O / R_{PAR})$$

The maximum dissipation a package can offer is:

$$P_D, \max = (T_D, \max - T_A, \max) / \theta_{JA}$$

where

$T_D, \max$  is the maximum die temperature, 150°C for reliability, less to retain optimum electrical performance

$T_A, \max$  is the ambient temperature, 70°C for commercial and 85°C for industrial range

$\theta_{JA}$  is the thermal resistance of the mounted package, obtained from datasheet dissipation curves

The more difficult case is the SO-14 package. With a maximum die temperature of 150°C and a maximum ambient temperature of 70°C, the 80°C temperature rise and package thermal resistance of 110°/W gives a dissipation of 636mW at 85°C.

This allows  $\pm 15V$  operation over the commercial temperature range, but higher ambient temperature or output loading may require lower supply voltages.

### Output Loading

The output stage of the EL4453 is very powerful. It typically can source 80mA and sink 120mA. Of course, this is too much current to sustain and the part will eventually be destroyed by excessive dissipation or by metal traces on the die opening. The metal traces are completely reliable while delivering the 30mA continuous output given in the Absolute

Maximum Ratings table in this data sheet, or higher purely transient currents.

Gain changes only 0.2% from no load to 100Ω load. Heavy resistive loading will degrade frequency response and video distortion for loads < 100Ω.

Capacitive loads will cause peaking in the frequency response. If capacitive loads must be driven, a small-valued series resistor can be used to isolate it. 12Ω to 51Ω should suffice. A 22Ω series resistor will limit peaking to 2.5dB with even a 220pF load.

All Intersil U.S. products are manufactured, assembled and tested utilizing ISO9000 quality systems.  
Intersil Corporation's quality certifications can be viewed at [www.intersil.com/design/quality](http://www.intersil.com/design/quality)

---

*Intersil products are sold by description only. Intersil Corporation reserves the right to make changes in circuit design, software and/or specifications at any time without notice. Accordingly, the reader is cautioned to verify that data sheets are current before placing orders. Information furnished by Intersil is believed to be accurate and reliable. However, no responsibility is assumed by Intersil or its subsidiaries for its use; nor for any infringements of patents or other rights of third parties which may result from its use. No license is granted by implication or otherwise under any patent or patent rights of Intersil or its subsidiaries.*

---

For information regarding Intersil Corporation and its products, see [www.intersil.com](http://www.intersil.com)