

2SB1031 (K)

SILICON PNP EPITAXIAL

LOW FREQUENCY POWER AMPLIFIER
COMPLEMENTARY PAIR WITH 2SD1435 (K)

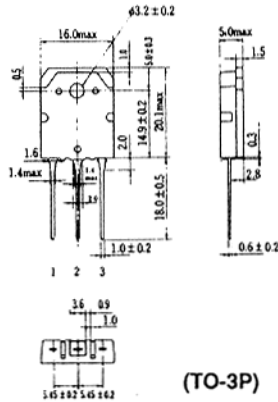

1. Base
 2. Collector (Flange)
 3. Emitter
- (Dimensions in mm)

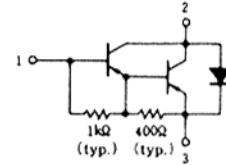

■ ABSOLUTE MAXIMUM RATINGS (Ta=25°C)

Item	Symbol	2SB1031 (K)	Unit
Collector to base voltage	V _{CB0}	-100	V
Collector to emitter voltage	V _{CEO}	-100	V
Emitter to base voltage	V _{EBO}	-7	V
Collector current	I _C	-15	A
Collector peak current	i _{C(peak)}	-20	A
Base current	I _B	-3	A
Collector power dissipation	P _C *	100	W
Junction temperature	T _j	150	°C
Storage temperature	T _{stg}	-55 to +150	°C

* Value at T_c = 25°C

MAXIMUM COLLECTOR DISSIPATION CURVE

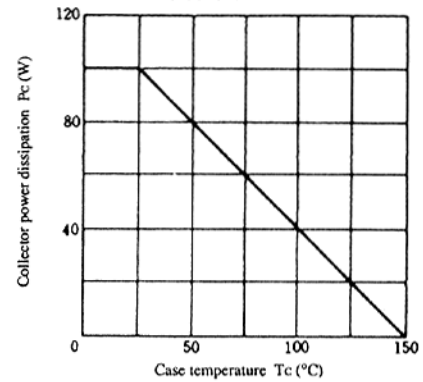

■ ELECTRICAL CHARACTERISTICS (Ta=25°C)

Item	Symbol	Test Condition	min.	typ.	max.	Unit
Collector to emitter breakdown voltage	V _{(BR)CEO}	I _C = -1mA, R _{BE} = ∞	-100	—	—	V
Emitter to base breakdown voltage	V _{(BR)EBO}	I _E = -50mA, I _C = 0	-7	—	—	V
Collector to emitter sustain voltage	V _{CEO(sus)}	I _C = -200mA, R _{BE} = ∞*	-100	—	—	V
Collector cutoff current	I _{CB0}	V _{CB} = -100V, I _E = 0	—	—	-100	μA
	I _{CEO}	V _{CE} = -80V, R _{BE} = ∞	—	—	-1.0	μA
DC current transfer ratio	h _{FE}	V _{CE} = -3V, I _C = -8A*	1000	—	20000	
Collector to emitter saturation voltage	V _{CE(sat)1}	I _C = -8A, I _B = -16mA*	—	—	-2.0	V
Base to emitter saturation voltage	V _{BE(sat)1}		—	—	-2.5	V
Collector to emitter saturation voltage	V _{CE(sat)2}	I _C = -15A, I _B = -150mA*	—	—	-3.0	V
Base to emitter saturation voltage	V _{BE(sat)2}		—	—	-3.5	V
Turn on time	t _{on}	I _C = -8A,	—	2	—	μs
Turn off time	t _{off}	I _{B1} = -I _{B2} = -16mA	—	8	—	μs

* Pulse Test

AREA OF SAFE OPERATION

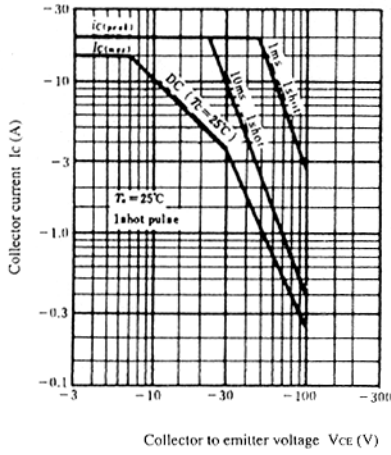

TYPICAL OUTPUT CHARACTERISTICS

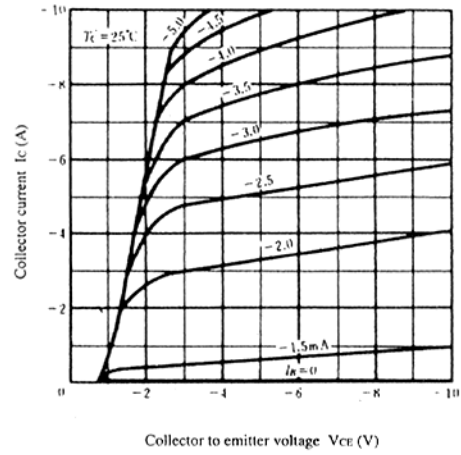

DC CURRENT TRANSFER RATIO VS. COLLECTOR CURRENT

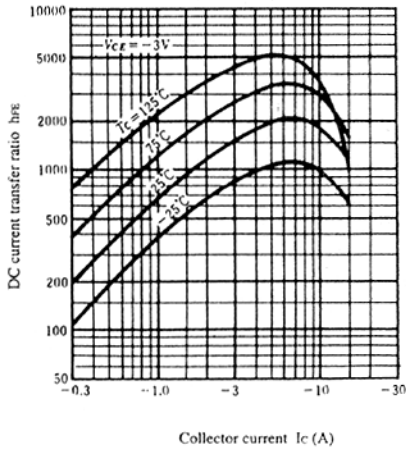

SATURATION VOLTAGE VS. COLLECTOR CURRENT

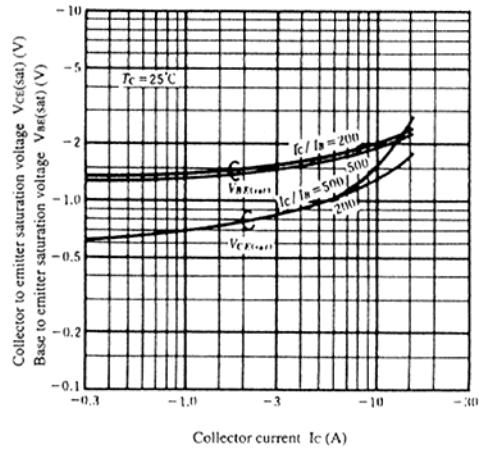

SWITCHING TIME TEST CIRCUIT

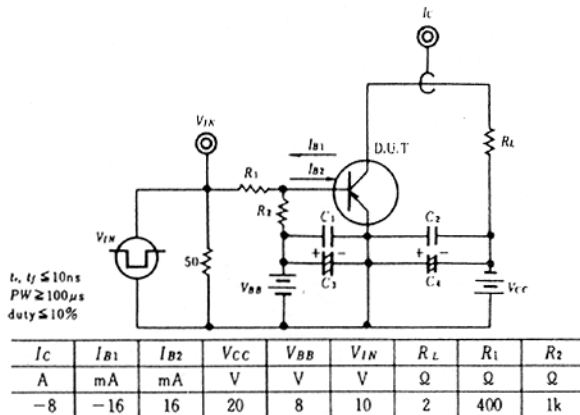

RESPONSE WAVEFORM

