

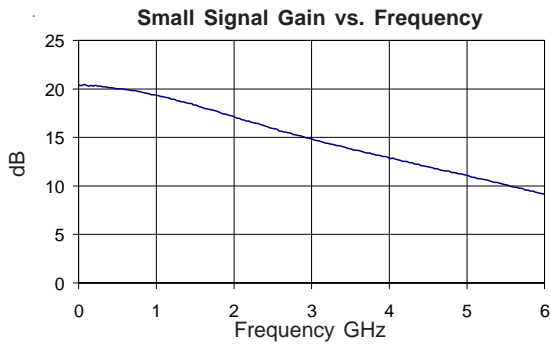

## Product Description

The SGA-0363 is a high performance SiGe HBT MMIC Amplifier. A Darlington configuration featuring 1 micron emitters provides high  $F_T$  and excellent thermal performance. The heterojunction increases breakdown voltage and minimizes leakage current between junctions. Cancellation of emitter junction non-linearities results in higher suppression of intermodulation products. Only 2 DC-blocking capacitors, a bias resistor and an optional RF choke are required for operation.

The matte tin finish on Sirenza's lead-free package utilizes a post annealing process to mitigate tin whisker formation and is RoHS compliant per EU Directive 2002/95. This package is also manufactured with green molding compounds that contain no antimony trioxide nor halogenated fire retardants.



Preliminary

## SGA-0363

## SGA-0363Z RoHS Compliant & Green Package

### DC-5000 MHz, Silicon Germanium Cascadeable Gain Block



### Product Features

- Now available in Lead Free, RoHS Compliant, & Green Packaging
- DC-5000 MHz Operation
- Single Voltage Supply
- Low Current Draw: 11mA at 2.5V typ.
- High Output Intercept: 14 dBm typ. at 1950MHz

### Applications

- PA Driver Amplifier
- Cellular, PCS, GSM, UMTS
- IF Amplifier
- Wireless Data, Satellite

Symbol	Parameter	Frequency	Units	Min.	Typ.	Max.
$P_{1dB}$	Output Power at 1dB Compression	850 MHz	dBm		2.3	
		1950 MHz	dBm		2.3	
		2400 MHz	dBm		1.6	
$IP_3$	Third Order Intercept Point	850 MHz	dBm		14.2	
		1950 MHz	dBm		14.0	
		2400 MHz	dBm		13.1	
$S_{21}$	Small Signal Gain	850 MHz	dB		19.6	
		1950 MHz	dB		17.2	
		2400 MHz	dB		16.2	
$BW_{3dB}$	3dB Bandwidth		MHz		5000	
$VSWR_{IN}$	Input VSWR	DC - 4500MHz	-		1.8:1	
$VSWR_{OUT}$	Output VSWR	DC - 4500MHz	-		1.7:1	
$S_{12}$	Reverse Isolation	850 MHz	dB		24.0	
		1950 MHz	dB		22.8	
		2400 MHz	dB		22.1	
NF	Noise Figure	1950 MHz	dB		3.0	
$V_D$	Device Operating Voltage		V		2.5	
$I_D$	Device Operating Current		mA	9	11	13
$R_{TH} j-l$	Thermal Resistance (junction - lead)		$^{\circ}C/W$		255	

**Test Conditions:**  $V_S = 5V$   $I_D = 11\text{ mA Typ.}$   $OIP_3$  Tone Spacing = 1 MHz,  $P_{out}$  per tone = -12 dBm  
 $R_{BIAS} = 220\text{ Ohms}$   $T_L = 25^{\circ}C$   $Z_S = Z_L = 50\text{ Ohms}$

The information provided herein is believed to be reliable at press time. Sirenza Microdevices assumes no responsibility for inaccuracies or omissions. Sirenza Microdevices assumes no responsibility for the use of this information, and all such information shall be entirely at the user's own risk. Prices and specifications are subject to change without notice. No patent rights or licenses to any of the circuits described herein are implied or granted to any third party. Sirenza Microdevices does not authorize or warrant any Sirenza Microdevices product for use in life-support devices and/or systems. Copyright 2001 Sirenza Microdevices, Inc.. All worldwide rights reserved.

Key parameters, at typical operating frequencies:

Parameter	Typical 25°C	Unit	Test Condition ( $I_D = 11\text{mA}$ , unless otherwise noted)
<b>100 MHz</b>			
Gain	20.4	dB	Tone spacing = 1 MHz, Pout per tone = -12dBm  $Z_s = 50\ \text{Ohms}$
Output IP3	14.8	dBm	
Output P1dB	3.2	dBm	
Input Return Loss	9.3	dB	
Reverse Isolation	23.9	dB	
Noise Figure	2.9	dB	
<b>500 MHz</b>			
Gain	20.0	dB	Tone spacing = 1 MHz, Pout per tone = -12dBm  $Z_s = 50\ \text{Ohms}$
Output IP3	14.5	dBm	
Output P1dB	2.9	dBm	
Input Return Loss	9.4	dB	
Reverse Isolation	23.9	dB	
Noise Figure	2.8	dB	
<b>850 MHz</b>			
Gain	19.6	dB	Tone spacing = 1 MHz, Pout per tone = -12dBm  $Z_s = 50\ \text{Ohms}$
Output IP3	14.2	dBm	
Output P1dB	2.3	dBm	
Input Return Loss	9.4	dB	
Reverse Isolation	24.0	dB	
Noise Figure	3.0	dB	
<b>1950 MHz</b>			
Gain	17.2	dB	Tone spacing = 1 MHz, Pout per tone = -12dBm  $Z_s = 50\ \text{Ohms}$
Output IP3	14.0	dBm	
Output P1dB	2.3	dBm	
Input Return Loss	10.4	dB	
Reverse Isolation	22.8	dB	
Noise Figure	3.0	dB	
<b>2400 MHz</b>			
Gain	16.2	dB	Tone spacing = 1 MHz, Pout per tone = -12dBm
Output IP3	13.1	dBm	
Output P1dB	1.6	dBm	
Input Return Loss	10.8	dB	
Reverse Isolation	22.1	dB	
<b>3500 MHz</b>			
Gain	13.8	dB	Tone spacing = 1 MHz, Pout per tone = -12dBm
Output IP3	11.5	dBm	
Output P1dB	0.8	dBm	
Input Return Loss	11.3	dB	
Reverse Isolation	20.1	dB	

Absolute Maximum Ratings

Parameter	Absolute Limit
Max. Device Current ( $I_D$ )	22 mA
Max. Device Voltage ( $V_D$ )	6 V
Max. RF Input Power	-5 dBm
Max. Junction Temp. ( $T_J$ )	+150°C
Operating Temp. Range ( $T_L$ )	-40°C to +85°C
Max. Storage Temp.	+150°C

Operation of this device beyond any one of these limits may cause permanent damage. For reliable continuous operation, the device voltage and current must not exceed the maximum operating values specified in the table on page one.

Bias conditions should also satisfy the following expression:

$$I_D V_D < (T_J - T_L) / R_{TH} \quad j-l$$

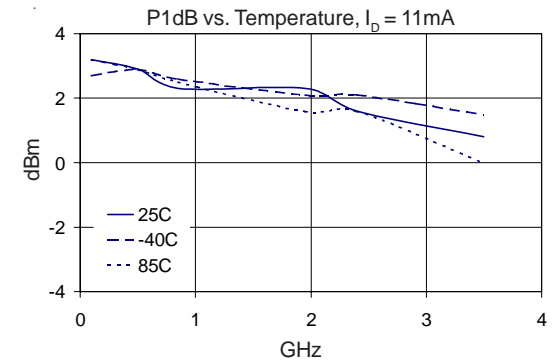
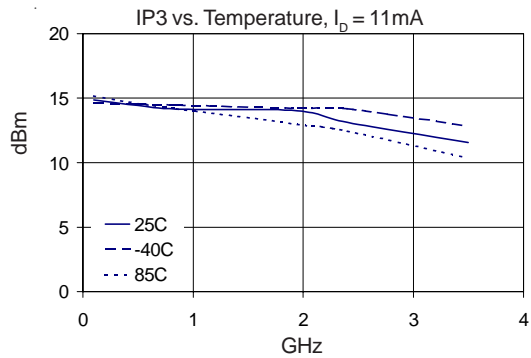
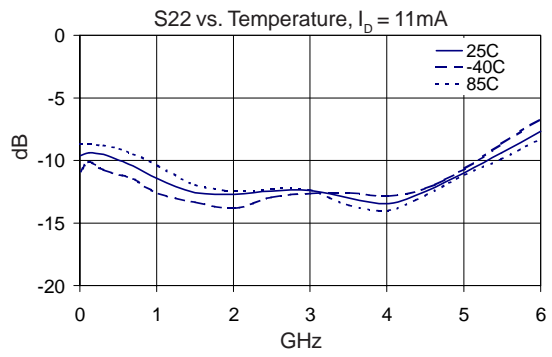
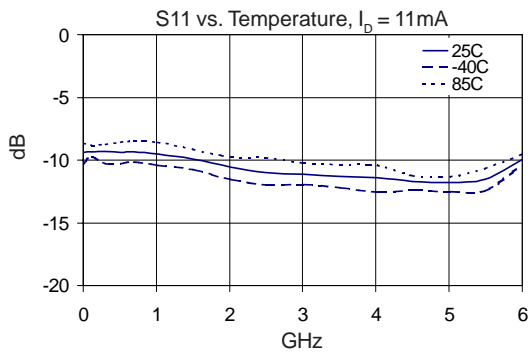
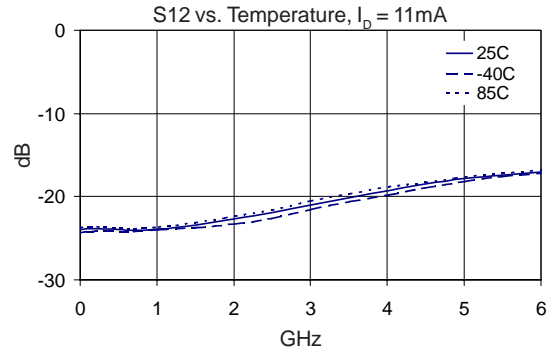
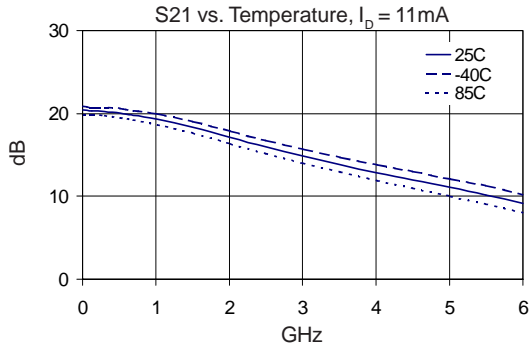

**Basic Application Circuit**

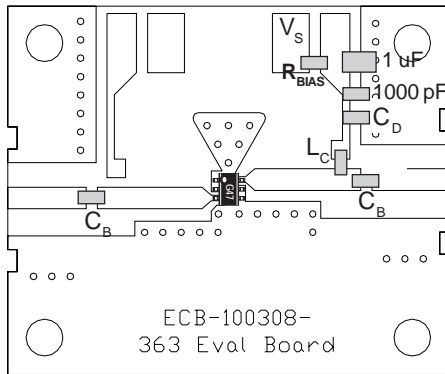
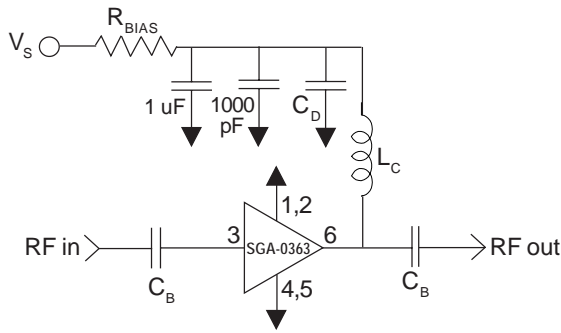

**Application Circuit Element Values**

Reference Designator	Frequency (Mhz)				
	500	850	1950	2400	3500
C <sub>B</sub>	220 pF	100 pF	68 pF	56 pF	39 pF
C <sub>D</sub>	100 pF	68 pF	22 pF	22 pF	15 pF
L <sub>C</sub>	68 nH	33 nH	22 nH	18 nH	15 nH

**Recommended Bias Resistor Values for I<sub>b</sub>=11mA**  
 $R_{BIAS} = (V_S - V_D) / I_D$

Supply Voltage(V <sub>S</sub> )	5 V	7.5 V	9 V	12 V
R <sub>BIAS</sub>	220 Ω	470 Ω	620 Ω	910 Ω

Note: R<sub>BIAS</sub> provides DC bias stability over temperature.

**Mounting Instructions**

1. Use a large ground pad area near device pins 1, 2, 4, and 5 with many plated through-holes as shown.
2. We recommend 1 or 2 ounce copper. Measurements for this data sheet were made on a 31 mil thick FR-4 board with 1 ounce copper on both sides.

**Part Identification Marking**

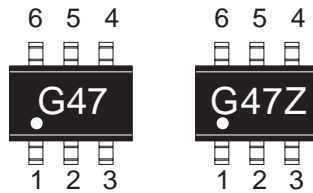

**Caution: ESD sensitive**  
 Appropriate precautions in handling, packaging and testing devices must be observed.

Pin #	Function	Description
3	RF IN	RF input pin. This pin requires the use of an external DC blocking capacitor chosen for the frequency of operation.
1, 2, 4, 5	GND	Connection to ground. Use via holes for best performance to reduce lead inductance as close to ground leads as possible.
6	RF OUT/BIAS	RF output and bias pin. DC voltage is present on this pin, therefore a DC blocking capacitor is necessary for proper operation.

Part Number	Reel Size	Devices/Reel
<b>SGA-0363</b>	<b>7"</b>	<b>3000</b>
<b>SGA-0363Z</b>	<b>7"</b>	<b>3000</b>

### SOT-363 PCB Pad Layout

Dimensions in inches [millimeters]

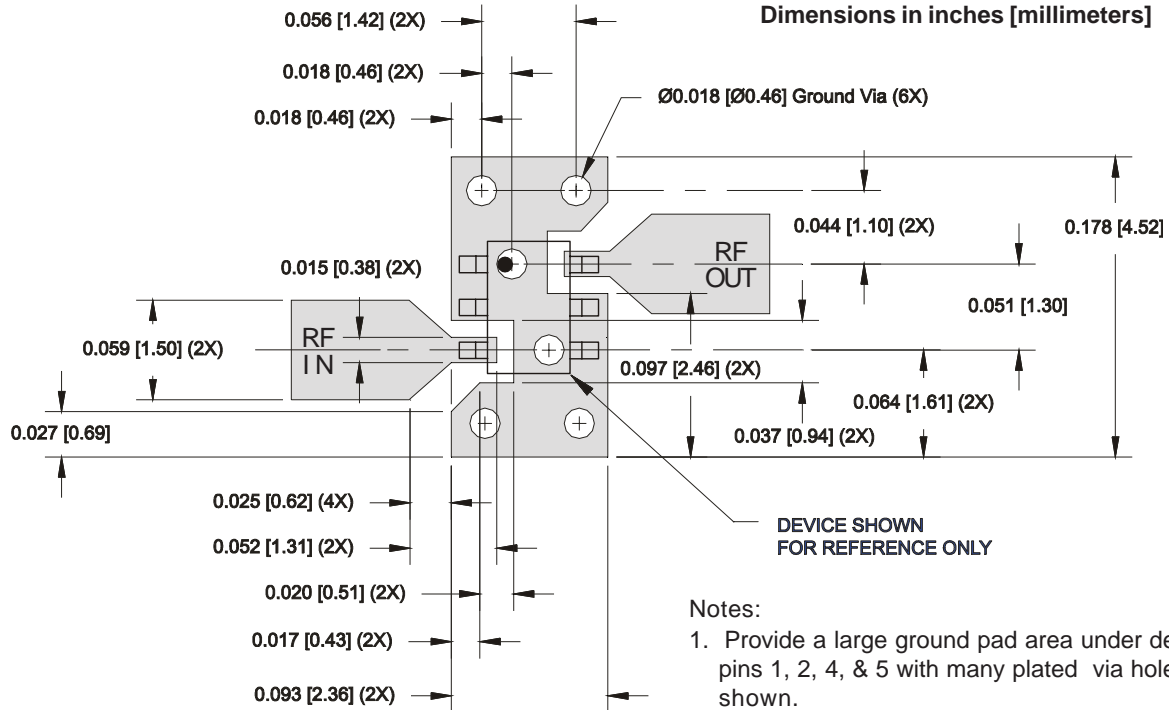

**Notes:**

1. Provide a large ground pad area under device pins 1, 2, 4, & 5 with many plated via holes as shown.
2. Dimensions given for 50 Ohm RF I/O lines are for 31 mil thick Getek. Scale accordingly for different board thicknesses and dielectric constants.
3. We recommend 1 or 2 ounce copper. Measurements for this data sheet were made on a 31 mil thick Getek with 1 ounce copper on both sides.

### SOT-363 Nominal Package Dimensions

Dimensions in inches [millimeters]

A link to the SOT-363 package outline drawing with full dimensions and tolerances may be found on the product web page at [www.sirenza.com](http://www.sirenza.com).

