

BAS19LT1, BAS20LT1, BAS21LT1, BAS21DW5T1

Preferred Devices

High Voltage Switching Diode

Device Marking:

- BAS19LT1 = JP
- BAS20LT1 = JR
- BAS21LT1 = JS
- BAS21DW5T1 = JS

Features

- Pb-Free Packages are Available

MAXIMUM RATINGS

Rating	Symbol	Value	Unit
Continuous Reverse Voltage BAS19 BAS20 BAS21	V_R	120 200 250	Vdc
Repetitive Peak Reverse Voltage BAS19 BAS20 BAS21	V_{RRM}	120 200 250	Vdc
Continuous Forward Current	I_F	200	mAdc
Peak Forward Surge Current	$I_{FM(surge)}$	625	mAdc
Maximum Junction Temperature	T_{Jmax}	150	°C
Power Dissipation (Note 4)	P_D	385	mW

Maximum ratings are those values beyond which device damage can occur. Maximum ratings applied to the device are individual stress limit values (not normal operating conditions) and are not valid simultaneously. If these limits are exceeded, device functional operation is not implied, damage may occur and reliability may be affected.

1. Mounted on FR-5 Board = 1.0 x 0.75 x 0.062 in.



ON Semiconductor®

<http://onsemi.com>

HIGH VOLTAGE SWITCHING DIODE

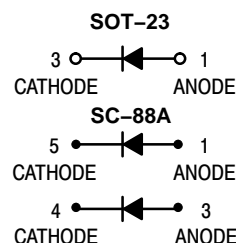

MARKING DIAGRAMS

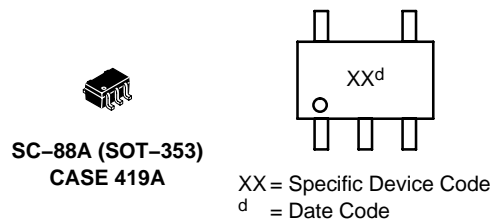
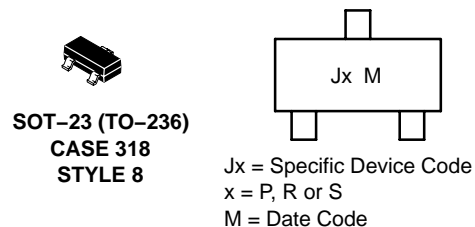

ORDERING INFORMATION

See detailed ordering and shipping information in the package dimensions section on page 4 of this data sheet.

Preferred devices are recommended choices for future use and best overall value.

BAS19LT1, BAS20LT1, BAS21LT1, BAS21DW5T1

THERMAL CHARACTERISTICS (SOT-23)

Characteristic	Symbol	Max	Unit
Total Device Dissipation FR-5 Board (Note 2) $T_A = 25^\circ\text{C}$ Derate above 25°C	P_D	225	mW
		1.8	mW/ $^\circ\text{C}$
Thermal Resistance Junction-to-Ambient (SOT-23)	$R_{\theta JA}$	556	$^\circ\text{C}/\text{W}$
Total Device Dissipation Alumina Substrate (Note 3) $T_A = 25^\circ\text{C}$ Derate above 25°C	P_D	300	mW
		2.4	mW/ $^\circ\text{C}$
Thermal Resistance Junction-to-Ambient	$R_{\theta JA}$	417	$^\circ\text{C}/\text{W}$
Junction and Storage Temperature Range	T_J, T_{stg}	-55 to +150	$^\circ\text{C}$

THERMAL CHARACTERISTICS (SC-88A)

Characteristic	Symbol	Max	Unit
Power Dissipation (Note 4)	P_D	385	mW
Thermal Resistance – Junction-to-Ambient Derate Above 25°C	$R_{\theta JA}$	328	$^\circ\text{C}/\text{W}$
		3.0	mW/ $^\circ\text{C}$
Maximum Junction Temperature	T_{Jmax}	150	$^\circ\text{C}$
Operating Junction and Storage Temperature Range	T_J, T_{stg}	-55 to +150	$^\circ\text{C}$

2. FR-5 = 1.0 × 0.75 × 0.062 in.

3. Alumina = 0.4 × 0.3 × 0.024 in. 99.5% alumina.

4. Mounted on FR-5 Board = 1.0 × 0.75 × 0.062 in.

ELECTRICAL CHARACTERISTICS ($T_A = 25^\circ\text{C}$ unless otherwise noted)

Characteristic	Symbol	Min	Max	Unit	
Reverse Voltage Leakage Current ($V_R = 100\text{ Vdc}$) ($V_R = 150\text{ Vdc}$) ($V_R = 200\text{ Vdc}$) ($V_R = 100\text{ Vdc}, T_J = 150^\circ\text{C}$) ($V_R = 150\text{ Vdc}, T_J = 150^\circ\text{C}$) ($V_R = 200\text{ Vdc}, T_J = 150^\circ\text{C}$)	I_R	BAS19	–	0.1	μAdc
		BAS20	–	0.1	
		BAS21	–	0.1	
		BAS19	–	100	
		BAS20	–	100	
		BAS21	–	100	
Reverse Breakdown Voltage ($I_{BR} = 100\ \mu\text{Adc}$) ($I_{BR} = 100\ \mu\text{Adc}$) ($I_{BR} = 100\ \mu\text{Adc}$)	$V_{(BR)}$	BAS19	120	–	Vdc
		BAS20	200	–	
		BAS21	250	–	
Forward Voltage ($I_F = 100\text{ mAdc}$) ($I_F = 200\text{ mAdc}$)	V_F	–	1.0	Vdc	
		–	1.25		
Diode Capacitance ($V_R = 0, f = 1.0\text{ MHz}$)	C_D	–	5.0	pF	
Reverse Recovery Time ($I_F = I_R = 30\text{ mAdc}, I_{R(REC)} = 3.0\text{ mAdc}, R_L = 100$)	t_{rr}	–	50	ns	

BAS19LT1, BAS20LT1, BAS21LT1, BAS21DW5T1

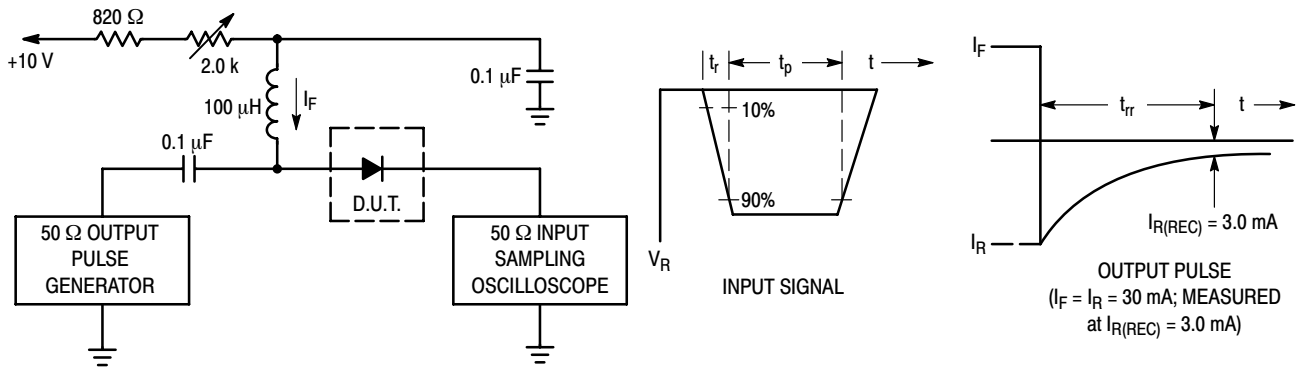

- Notes:
1. A 2.0 kΩ variable resistor adjusted for a Forward Current (I_F) of 30 mA.
 2. Input pulse is adjusted so $I_{R(\text{peak})}$ is equal to 30 mA.
 3. $t_p \gg t_{rr}$

Figure 1. Recovery Time Equivalent Test Circuit

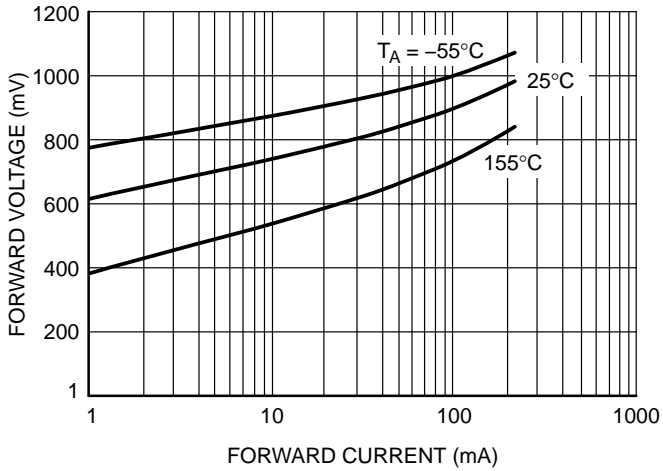

Figure 2. Forward Voltage

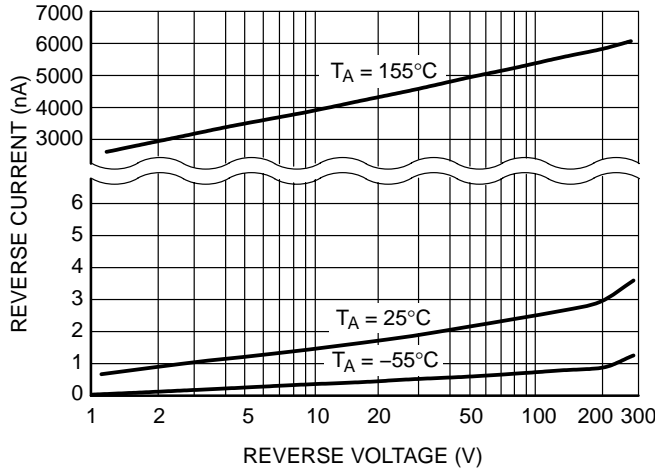

Figure 3. Reverse Leakage

BAS19LT1, BAS20LT1, BAS21LT1, BAS21DW5T1

ORDERING INFORMATION

Device	Package	Shipping†
BAS19LT1	SOT-23	3000 Tape/Reel
BAS19LT1G	SOT-23 (Pb-Free)	
BAS19LT3	SOT-23	10000 Tape/Reel
BAS19LT3G	SOT-23 (Pb-Free)	
BAS20LT1	SOT-23	3000 Tape/Reel
BAS20LT1G	SOT-23 (Pb-Free)	
BAS21LT1	SOT-23	3000 Tape/Reel
BAS21LT1G	SOT-23 (Pb-Free)	
BAS21LT3	SOT-23	10000 Tape/Reel
BAS21LT3G	SOT-23 (Pb-Free)	
BAS21DW5T1	SC-88A	3000 Tape/Reel
BAS21DW5T1G	SC-88A (Pb-Free)	

†For information on tape and reel specifications, including part orientation and tape sizes, please refer to our Tape and Reel Packaging Specifications Brochure, BRD8011/D.

BAS19LT1, BAS20LT1, BAS21LT1, BAS21DW5T1

PACKAGE DIMENSIONS

SOT-23 (TO-236)
CASE 318-09
ISSUE AH

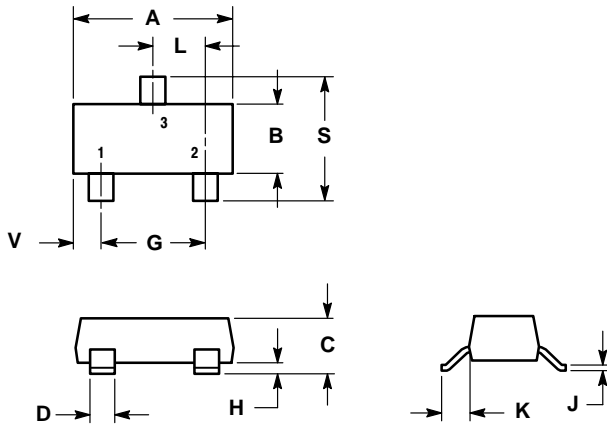

NOTES:

1. DIMENSIONING AND TOLERANCING PER ANSI Y14.5M, 1982.
2. CONTROLLING DIMENSION: INCH.
3. MAXIMUM LEAD THICKNESS INCLUDES LEAD FINISH THICKNESS. MINIMUM LEAD THICKNESS IS THE MINIMUM THICKNESS OF BASE MATERIAL.
4. 318-01, -02, AND -06 OBSOLETE, NEW STANDARD 318-09.

DIM	INCHES		MILLIMETERS	
	MIN	MAX	MIN	MAX
A	0.1102	0.1197	2.80	3.04
B	0.0472	0.0551	1.20	1.40
C	0.0385	0.0498	0.99	1.26
D	0.0140	0.0200	0.36	0.50
G	0.0670	0.0826	1.70	2.10
H	0.0040	0.0098	0.10	0.25
J	0.0034	0.0070	0.085	0.177
K	0.0180	0.0236	0.45	0.60
L	0.0350	0.0401	0.89	1.02
S	0.0830	0.0984	2.10	2.50
V	0.0177	0.0236	0.45	0.60

STYLE 8:

1. ANODE
2. NO CONNECTION
3. CATHODE

SOLDERING FOOTPRINT*

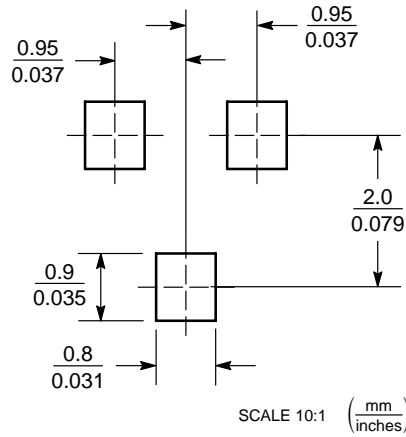

*For additional information on our Pb-Free strategy and soldering details, please download the ON Semiconductor Soldering and Mounting Techniques Reference Manual, SOLDERRM/D.

BAS19LT1, BAS20LT1, BAS21LT1, BAS21DW5T1

PACKAGE DIMENSIONS

SC-88A (SOT-353) CASE 419A-02 ISSUE G

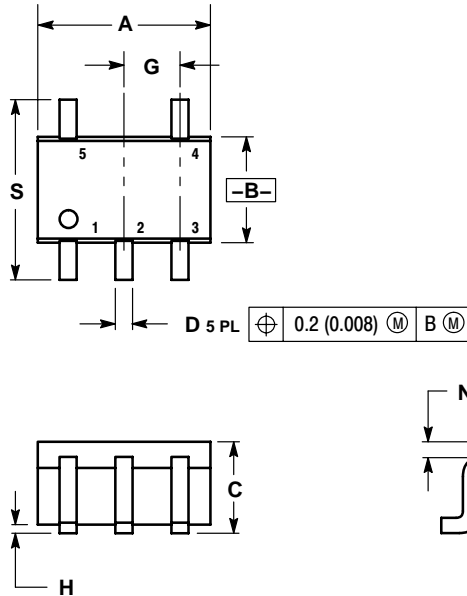

NOTES:

1. DIMENSIONING AND TOLERANCING PER ANSI Y14.5M, 1982.
2. CONTROLLING DIMENSION: INCH.
3. 419A-01 OBSOLETE. NEW STANDARD 419A-02.
4. DIMENSIONS A AND B DO NOT INCLUDE MOLD FLASH, PROTRUSIONS, OR GATE BURRS.

DIM	INCHES		MILLIMETERS	
	MIN	MAX	MIN	MAX
A	0.071	0.087	1.80	2.20
B	0.045	0.053	1.15	1.35
C	0.031	0.043	0.80	1.10
D	0.004	0.012	0.10	0.30
G	0.026 BSC		0.65 BSC	
H	---	0.004	---	0.10
J	0.004	0.010	0.10	0.25
K	0.004	0.012	0.10	0.30
N	0.008 REF		0.20 REF	
S	0.079	0.087	2.00	2.20

SOLDERING FOOTPRINT*

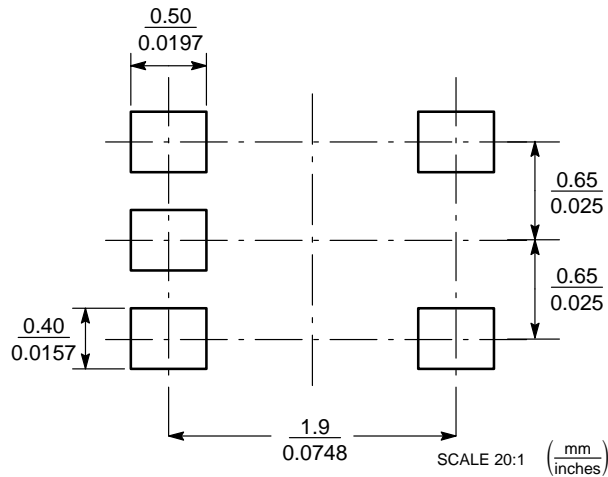

*For additional information on our Pb-Free strategy and soldering details, please download the ON Semiconductor Soldering and Mounting Techniques Reference Manual, SOLDERRM/D.

ON Semiconductor and are registered trademarks of Semiconductor Components Industries, LLC (SCILLC). SCILLC reserves the right to make changes without further notice to any products herein. SCILLC makes no warranty, representation or guarantee regarding the suitability of its products for any particular purpose, nor does SCILLC assume any liability arising out of the application or use of any product or circuit, and specifically disclaims any and all liability, including without limitation special, consequential or incidental damages. "Typical" parameters which may be provided in SCILLC data sheets and/or specifications can and do vary in different applications and actual performance may vary over time. All operating parameters, including "Typicals" must be validated for each customer application by customer's technical experts. SCILLC does not convey any license under its patent rights nor the rights of others. SCILLC products are not designed, intended, or authorized for use as components in systems intended for surgical implant into the body, or other applications intended to support or sustain life, or for any other application in which the failure of the SCILLC product could create a situation where personal injury or death may occur. Should Buyer purchase or use SCILLC products for any such unintended or unauthorized application, Buyer shall indemnify and hold SCILLC and its officers, employees, subsidiaries, affiliates, and distributors harmless against all claims, costs, damages, and expenses, and reasonable attorney fees arising out of, directly or indirectly, any claim of personal injury or death associated with such unintended or unauthorized use, even if such claim alleges that SCILLC was negligent regarding the design or manufacture of the part. SCILLC is an Equal Opportunity/Affirmative Action Employer. This literature is subject to all applicable copyright laws and is not for resale in any manner.

PUBLICATION ORDERING INFORMATION

LITERATURE FULFILLMENT:

Literature Distribution Center for ON Semiconductor
P.O. Box 611312, Phoenix, Arizona 85082-1312 USA
Phone: 480-829-7710 or 800-344-3860 Toll Free USA/Canada
Fax: 480-829-7709 or 800-344-3867 Toll Free USA/Canada
Email: orderlit@onsemi.com

N. American Technical Support: 800-282-9855 Toll Free
USA/Canada

Japan: ON Semiconductor, Japan Customer Focus Center
2-9-1 Kamimeguro, Meguro-ku, Tokyo, Japan 153-0051
Phone: 81-3-5773-3850

ON Semiconductor Website: <http://onsemi.com>

Order Literature: <http://www.onsemi.com/litorder>

For additional information, please contact your local Sales Representative.