

AMMC-5024

30 KHz – 40 GHz Traveling Wave Amplifier



Data Sheet

Description

Avago Technologies' AMMC-5024 is a broadband PHEMT GaAs MMIC TWA designed for medium output power and high gain over the full 30 KHz to 40 GHz frequency

range. The design employs a 9-stage, cascade-connected FET structure to ensure flat gain and power as well as uniform group delay. E-beam lithography is used to produce uniform gate lengths of 0.15 μm and MBE technology assures precise semiconductor layer control. For improved reliability and moisture protection, the die is passivated at the active areas.

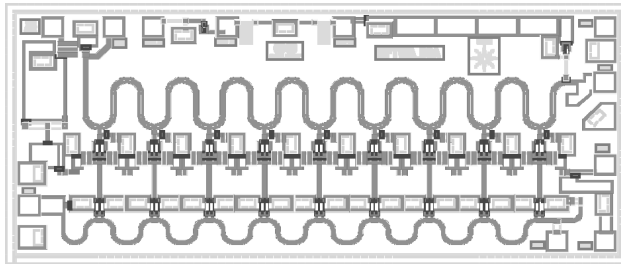

Chip Size: 2350 x 1050 μm (92.5 x 41.3 mils)
 Chip Size Tolerance: $\pm 10 \mu\text{m}$ (± 0.4 mils)
 Chip Thickness: 100 \pm 10 μm (4 \pm 0.4 mils)
 Pad Dimensions: 80 x 80 μm (2.95 x 0.4 mils)

Features

- Wide frequency range: 30 KHz – 40 GHz
- High gain: 16 dB
- Gain flatness: ± 0.75 dB
- Return loss:
Input: 13 dB, Output: 13 dB
- Medium power: P-1dB = 22.5 dBm at 22 GHz
- Low noise figure: 4.6 dB at 26 GHz

Applications

- Communication systems
- Microwave instrumentation
- Optical systems
- Broadband applications requiring flat gain and group delay with excellent input and output port matches over the 30 KHz and 40 GHz frequency range

Absolute Maximum Ratings^[1]

Symbol	Parameters/Conditions	Units	Min.	Max.
V _{dd}	Positive Drain Voltage	V		10
I _{dd}	Total Drain Current	mA		340
V _{g1}	First Gate Voltage	V	-9.5	0
I _{g1}	First Gate Current	mA	-38	+1
V _{g2}	Second Gate Voltage	V	-3.5	+4
I _{g2}	Second Gate Current	mA	-20	
P _{in}	CW Input Power	dBm		17
T _{ch}	Operating Channel Temperature	°C		+150
T _b	Operating Backside Temperature	°C	-55	
T _{stg}	Storage Temperature	°C	-65	+165
T _{max}	Max. Assembly Temp (60 sec max)	°C		+300

Notes:

1. Absolute maximum ratings for continuous operation unless otherwise noted.

AMMC-5024 DC Specifications/Physical Properties^[1]

Symbol	Parameters and Test Conditions	Units	Min.	Typ.	Max.
I_{dss}	Saturated Drain Current ($V_{dd}=7\text{ V}$, $V_{g1}=0\text{ V}$, $V_{g2}=\text{open circuit}$)	mA	265	350	385
V_p	First Gate Pinch-off Voltage ($V_{dd}=7\text{ V}$, $I_{dd}=30\text{ mA}$, $V_{g2}=\text{open circuit}$)	V		-8.2	
V_{g2}	Second Gate Self-bias Voltage ($V_{dd}=7\text{ V}$, $I_{dd}=200\text{ mA}$, $V_{g2}=\text{open circuit}$)	V		2.75	
I_{dsmin} (V_{g1})	First Gate Minimum Drain Current ($V_{dd}=7\text{ V}$, $V_{g1}=-7\text{ V}$, $V_{g2}=\text{open circuit}$)	mA		47	
I_{dsmin} (V_{g2})	Second Gate Minimum Drain Current ($V_{dd}=7\text{ V}$, $V_{g1}=0\text{ V}$, $V_{g2}=-3.5\text{ V}$)	mA		105	
θ_{ch-b}	Thermal Resistance ^[2] (Backside temperature, $T_b = 25^\circ\text{C}$)	$^\circ\text{C/W}$		52	

RF Specifications for High Power Applications^[2, 3] ($V_{dd}=7\text{ V}$, $I_{dd}(Q)=200\text{ mA}$, $Z_{in}=Z_o=50\Omega$)

Symbol	Parameters and Test Conditions	Units	Min.	Typ.	Max.
$ S_{21} ^2$	Small-signal Gain	dB	14	16	18
$\Delta S_{21} ^2$	Small-signal Gain Flatness	dB		± 0.75	± 2
RL_{in}	Input Return Loss	dB	12	16.9	
RL_{out}	Output Return Loss	dB	10	16.8	
$ S_{12} ^2$	Isolation	dB	26	28	
P_{-1dB}	Output Power @ 1 dB Gain Compression	$f = 22\text{ GHz}$ dBm	21	22.5	
P_{sat}	Saturated Output Power	$f = 22\text{ GHz}$ dBm	23	24.5	
OIP3	Output 3 rd Order Intercept Point, $Rf_{in1} = Rf_{in2} = 2\text{ dBm}$, $f = 22\text{ GHz}$, $\Delta f = 2\text{ MHz}$	dBm	27	30	
NF	Noise Figure ($V_{ds} = 3\text{ V}$, $I_{ds} = 140\text{ mA}$)	$f = 26\text{ GHz}$ $f = 40\text{ GHz}$ dB		4.6 7.2	6.5 9

RF Specifications for High Gain and Low Power Applications^[2, 3] ($V_{dd}=4\text{ V}$, $I_{dd}(Q)=160\text{ mA}$, $Z_{in}=Z_o=50\Omega$)

Symbol	Parameters and Test Conditions	Units	Min.	Typ.	Max.
$ S_{21} ^2$	Small-signal Gain	dB		17.5	
$\Delta S_{21} ^2$	Small-signal Gain Flatness	dB		± 1.5	
RL_{in}	Minimum Input Return Loss	dB		13	
RL_{out}	Minimum Output Return Loss	dB		13	
$ S_{12} ^2$	Isolation	dB		30	
P_{-1dB}	Output Power @ 1 dB Gain Compression	$f = 22\text{ GHz}$ dBm		17.3	
P_{sat}	Saturated Output Power	$f = 22\text{ GHz}$ dBm		20.5	
OIP3	Output 3 rd Order Intercept Point, $Rf_{in1} = Rf_{in2} = 2\text{ dBm}$, $f = 22\text{ GHz}$, $\Delta f = 2\text{ MHz}$	dBm		22.5	
NF	Noise Figure	$f = 26\text{ GHz}$ $f = 40\text{ GHz}$ dB		3.7 5.5	

Notes:

1. Backside temperature $T_b = 25^\circ\text{C}$ unless otherwise noted.
2. Data measured in wafer form, $T_{chuck} = 25^\circ\text{C}$
3. 100% on-wafer RF test is done at frequency = 2, 10, 20, 30 and 40 GHz, except as noted.

AMMC-5024 Typical Performance ($T_{\text{chuck}} = 25^{\circ}\text{C}$, $V_{\text{dd}} = 7\text{V}$, $I_{\text{dd}} = 200\text{ mA}$, $V_{\text{g2}} = \text{Open}$, $Z_0 = 50\Omega$)

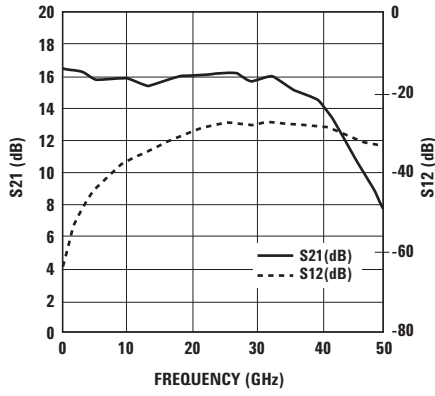

Figure 1. Gain and Reverse Isolation.

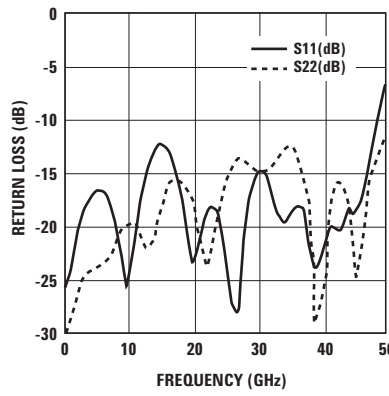

Figure 2. Return Loss (Input and Output).

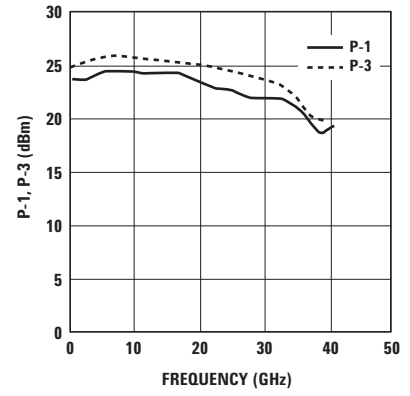

Figure 3. Output Power (P-1 and P-3).

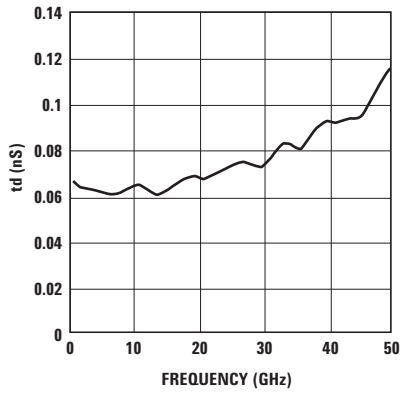

Figure 4. Group Delay.

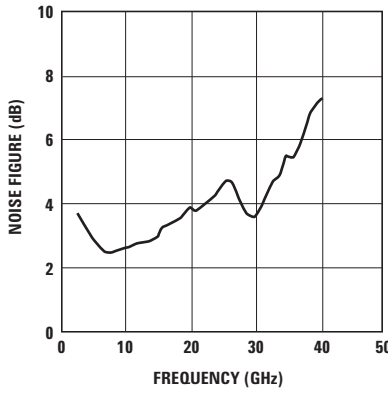

Figure 5. Noise Figure.

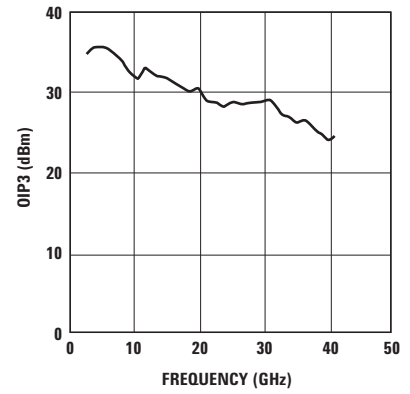

Figure 6. Output IP3.

AMMC-5024 Typical Scattering Parameters^[1] ($T_{\text{chuck}} = 25^{\circ}\text{C}$, $V_{\text{DD}} = 7\text{V}$, $I_{\text{DD}} = 200\text{mA}$, $Z_{\text{in}} = Z_{\text{out}} = 50\Omega$)

Freq. GHz	S_{11}			S_{21}			S_{12}			S_{22}		
	dB	Mag	Phase	dB	Mag	Phase	dB	Mag	Phase	dB	Mag	Phase
0.05	-26.524	0.047	-174.370	16.526	6.703	179.390	-66.134	0.000	-56.514	-29.620	0.033	7.766
1	-24.941	0.057	-154.440	16.375	6.588	155.660	-61.862	0.001	-109.670	-29.934	0.032	12.796
2	-21.885	0.080	-146.320	16.277	6.514	133.110	-55.350	0.002	-132.750	-26.919	0.045	18.718
3	-19.412	0.107	-149.270	16.170	6.434	110.580	-51.048	0.003	-153.970	-25.153	0.055	10.362
4	-17.725	0.130	-157.970	16.016	6.321	88.271	-48.620	0.004	-174.570	-24.391	0.060	0.922
5	-16.970	0.142	-168.560	15.868	6.214	66.412	-46.356	0.005	165.210	-24.068	0.063	-7.610
6	-16.940	0.142	-179.420	15.731	6.117	44.780	-44.560	0.006	144.510	-23.775	0.065	-12.684
7	-17.741	0.130	170.600	15.646	6.058	23.511	-42.719	0.007	123.530	-22.940	0.071	-18.420
8	-19.505	0.106	163.170	15.636	6.051	2.105	-41.197	0.009	102.140	-21.619	0.083	-28.987
9	-22.752	0.073	163.190	15.679	6.081	-19.628	-39.902	0.010	80.129	-20.245	0.097	-47.192
10	-25.795	0.051	-165.530	15.733	6.119	-42.046	-38.851	0.011	58.121	-19.716	0.103	-73.520
11	-21.613	0.083	-134.230	15.705	6.099	-64.823	-37.914	0.013	36.356	-20.130	0.099	-109.900
12	-17.435	0.134	-136.040	15.558	5.997	-87.590	-37.130	0.014	15.803	-21.644	0.083	-157.830
13	-14.804	0.182	-147.840	15.381	5.876	-109.420	-36.350	0.015	-4.845	-22.284	0.077	137.330
14	-13.213	0.218	-163.030	15.307	5.826	-130.680	-35.589	0.017	-25.521	-20.256	0.097	76.041
15	-12.628	0.234	-179.470	15.351	5.855	-152.100	-34.692	0.018	-45.793	-18.092	0.125	29.951
16	-12.989	0.224	163.010	15.496	5.954	-174.100	-33.794	0.020	-67.515	-16.431	0.151	-7.571
17	-14.171	0.196	147.400	15.663	6.070	163.120	-32.937	0.023	-90.266	-15.737	0.163	-40.792
18	-16.678	0.147	135.040	15.812	6.174	139.670	-32.208	0.025	-113.940	-15.813	0.162	-74.475
19	-20.641	0.093	130.070	15.870	6.216	115.610	-31.690	0.026	-137.810	-16.780	0.145	-106.600
20	-23.782	0.065	154.470	15.863	6.211	91.770	-31.208	0.028	-161.750	-18.810	0.115	-142.950
21	-21.425	0.085	177.240	15.823	6.182	67.954	-30.781	0.029	174.640	-21.397	0.085	169.440
22	-19.193	0.110	173.670	15.856	6.206	44.285	-30.231	0.031	151.020	-23.661	0.066	104.260
23	-18.288	0.122	156.910	15.922	6.253	20.329	-29.783	0.032	126.440	-21.101	0.088	34.057
24	-19.046	0.112	138.050	16.022	6.326	-4.276	-29.336	0.034	100.950	-18.085	0.125	-13.560
25	-21.832	0.081	114.120	16.122	6.399	-29.641	-28.991	0.036	75.101	-15.617	0.166	-54.765
26	-27.570	0.042	67.164	16.137	6.410	-55.651	-28.757	0.036	47.960	-14.258	0.194	-92.329
27	-28.076	0.039	-50.074	16.057	6.351	-82.011	-28.622	0.037	20.890	-13.705	0.206	-131.060
28	-20.068	0.099	-96.000	15.869	6.215	-108.060	-28.763	0.036	-6.265	-13.717	0.206	-171.110
29	-16.785	0.145	-121.770	15.675	6.078	-133.780	-28.808	0.036	-33.072	-14.430	0.190	145.610
30	-15.212	0.174	-145.820	15.567	6.003	-158.990	-28.853	0.036	-59.523	-15.005	0.178	97.895
31	-14.889	0.180	-168.310	15.661	6.068	175.180	-28.759	0.036	-86.846	-15.146	0.175	46.328
32	-16.789	0.145	173.110	15.788	6.158	147.730	-28.591	0.037	-115.960	-14.682	0.184	-10.820
33	-18.936	0.113	166.700	15.810	6.173	118.780	-28.536	0.037	-146.370	-13.588	0.209	-62.908
34	-19.985	0.100	177.880	15.612	6.034	89.206	-28.676	0.037	-177.890	-12.883	0.227	-111.430
35	-19.130	0.111	179.680	15.269	5.800	60.446	-28.992	0.036	151.190	-12.719	0.231	-155.460
36	-18.210	0.123	160.620	15.025	5.640	32.215	-29.214	0.035	120.660	-13.861	0.203	164.720
37	-18.457	0.119	134.410	14.926	5.576	3.374	-29.344	0.034	90.933	-15.387	0.170	122.630
38	-22.391	0.076	91.975	14.869	5.539	-27.424	-29.287	0.034	60.092	-19.170	0.110	84.484
39	-24.387	0.060	23.468	14.636	5.393	-59.455	-29.189	0.035	27.357	-30.763	0.029	20.516
40	-22.649	0.074	-37.468	14.174	5.113	-92.328	-29.513	0.033	-6.508	-24.452	0.060	-146.250
41	-20.369	0.096	-74.314	13.581	4.776	-124.820	-29.849	0.032	-39.965	-17.619	0.132	165.520
42	-20.473	0.095	-84.567	12.946	4.439	-157.360	-30.351	0.030	-73.488	-16.143	0.156	133.010
43	-20.560	0.094	-91.634	12.305	4.123	169.650	-30.858	0.029	-107.270	-16.259	0.154	99.260
44	-18.778	0.115	-92.252	11.524	3.769	136.220	-31.563	0.026	-142.290	-18.606	0.117	76.664
45	-19.072	0.111	-85.034	10.748	3.447	103.130	-32.440	0.024	-175.820	-24.603	0.059	93.515
46	-18.104	0.124	-73.258	10.059	3.184	69.590	-33.098	0.022	150.230	-21.717	0.082	135.190
47	-14.701	0.184	-64.708	9.479	2.978	34.467	-33.500	0.021	119.650	-15.939	0.160	122.900
48	-11.446	0.268	-65.771	8.863	2.774	-3.117	-33.995	0.020	83.945	-13.445	0.213	114.170
49	-9.005	0.355	-76.848	8.007	2.514	-42.656	-33.996	0.020	49.390	-12.285	0.243	89.641
50	-6.637	0.466	-89.734	6.902	2.214	-83.972	-34.691	0.018	15.240	-11.324	0.272	78.671

Note:

1. Data obtained from on-wafer measurements.

AMMC-5024 Typical Performance ($T_{\text{chuck}} = 25^{\circ}\text{C}$, $V_{\text{dd}} = 4\text{V}$, $I_{\text{dd}} = 160\text{ mA}$, $V_{\text{g2}} = \text{Open}$, $Z_0 = 50\Omega$)

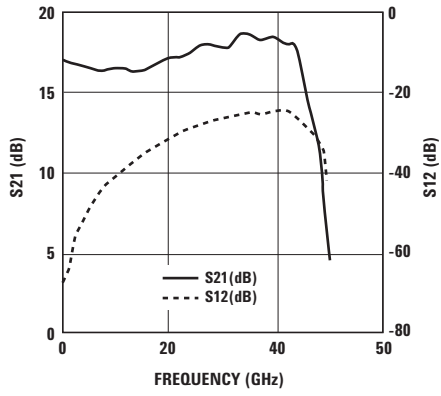

Figure 7. Gain and Reverse Isolation.

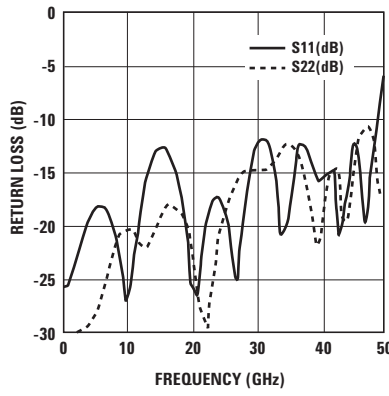

Figure 8. Return Loss (Input and Output).

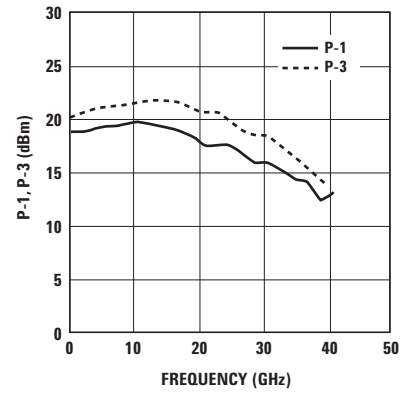

Figure 9. Output Power (P-1 and P-3).

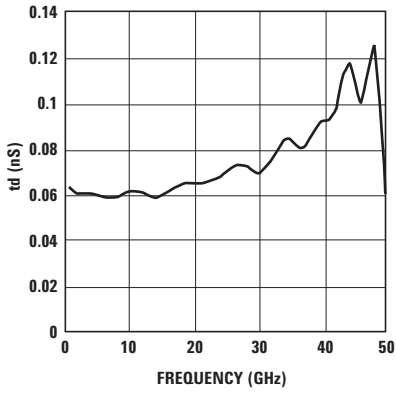

Figure 10. Group Delay.

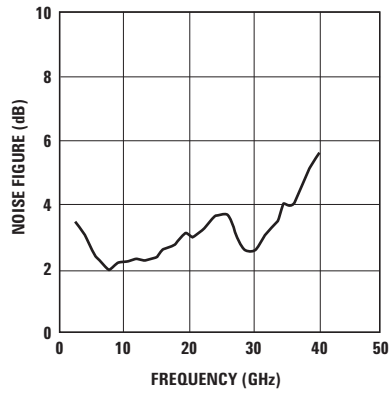

Figure 11. Noise Figure.

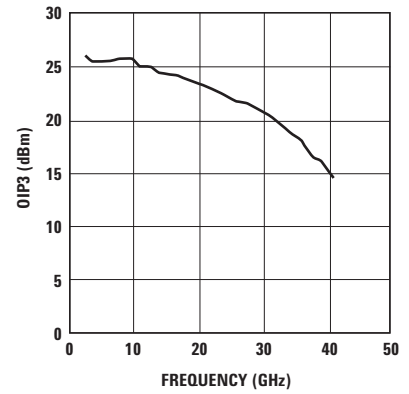

Figure 12. Output IP3.

AMMC-5024 Typical Scattering Parameters^[1] ($T_{\text{chuck}} = 25^{\circ}\text{C}$, $V_{\text{DD}} = 4\text{V}$, $I_{\text{DD}} = 160\text{mA}$, $Z_{\text{in}} = Z_{\text{out}} = 50\Omega$)

Freq. GHz	S_{11}			S_{21}			S_{12}			S_{22}		
	dB	Mag	Phase	dB	Mag	Phase	dB	Mag	Phase	dB	Mag	Phase
0.05	-26.046	0.050	-175.110	16.908	7.005	179.610	-59.336	0.001	-61.940	-32.459	0.024	16.703
1	-25.998	0.050	-164.940	16.786	6.907	156.790	-65.942	0.001	-108.900	-34.057	0.020	5.690
2	-24.392	0.060	-151.920	16.727	6.860	135.230	-59.134	0.001	-128.490	-31.519	0.027	17.159
3	-22.084	0.079	-147.760	16.657	6.805	113.560	-54.398	0.002	-158.090	-30.113	0.031	12.590
4	-20.032	0.100	-152.230	16.538	6.713	92.010	-52.371	0.002	-178.300	-29.546	0.033	10.367
5	-18.871	0.114	-160.550	16.419	6.621	70.825	-49.621	0.003	161.460	-28.527	0.037	9.842
6	-18.430	0.120	-170.290	16.305	6.535	49.938	-47.520	0.004	141.190	-26.705	0.046	8.417
7	-18.727	0.116	179.750	16.225	6.475	29.369	-45.659	0.005	119.280	-24.546	0.059	-0.474
8	-19.934	0.101	170.600	16.227	6.476	8.799	-43.865	0.006	97.498	-22.558	0.074	-17.521
9	-22.656	0.074	164.210	16.287	6.522	-12.033	-42.482	0.008	74.972	-21.031	0.089	-41.715
10	-27.478	0.042	-179.640	16.384	6.595	-33.532	-41.201	0.009	53.471	-20.499	0.094	-72.840
11	-25.347	0.054	-126.840	16.410	6.614	-55.435	-40.162	0.010	31.594	-20.801	0.091	-112.770
12	-19.749	0.103	-120.480	16.336	6.559	-77.463	-39.239	0.011	10.910	-21.844	0.081	-161.860
13	-16.206	0.155	-131.310	16.209	6.464	-98.816	-38.327	0.012	-9.819	-22.131	0.078	138.490
14	-14.011	0.199	-146.840	16.158	6.425	-119.500	-37.323	0.014	-29.734	-20.818	0.091	82.104
15	-12.962	0.225	-164.520	16.210	6.464	-140.230	-36.407	0.015	-50.251	-19.513	0.106	36.945
16	-12.935	0.226	176.980	16.352	6.570	-161.440	-35.276	0.017	-72.076	-18.421	0.120	-0.979
17	-13.689	0.207	159.730	16.530	6.707	176.800	-34.270	0.019	-94.562	-18.158	0.124	-34.038
18	-15.570	0.167	143.690	16.717	6.853	154.440	-33.419	0.021	-118.010	-18.744	0.116	-67.232
19	-19.085	0.111	128.620	16.846	6.955	131.460	-32.607	0.023	-141.710	-20.205	0.098	-96.759
20	-25.363	0.054	133.080	16.926	7.020	108.520	-31.889	0.025	-166.020	-23.130	0.070	-128.700
21	-26.442	0.048	-165.970	16.965	7.051	85.461	-31.268	0.027	169.730	-27.569	0.042	-173.310
22	-20.900	0.090	-156.420	17.054	7.124	62.568	-30.682	0.029	145.660	-33.534	0.021	98.102
23	-18.349	0.121	-172.490	17.170	7.220	39.543	-30.022	0.032	121.250	-26.084	0.050	10.942
24	-17.560	0.132	168.580	17.320	7.345	16.078	-29.439	0.034	96.409	-21.809	0.081	-29.430
25	-18.343	0.121	145.730	17.534	7.528	-8.082	-28.885	0.036	70.972	-18.685	0.116	-66.154
26	-20.831	0.091	110.490	17.708	7.680	-32.996	-28.374	0.038	44.076	-16.869	0.143	-100.080
27	-25.482	0.053	47.234	17.813	7.774	-58.575	-27.893	0.040	17.025	-15.693	0.164	-136.500
28	-21.019	0.089	-43.397	17.786	7.750	-84.438	-27.722	0.041	-10.669	-15.062	0.177	-174.690
29	-15.842	0.161	-84.248	17.674	7.651	-110.030	-27.501	0.042	-38.170	-15.047	0.177	144.500
30	-13.096	0.221	-115.690	17.547	7.540	-134.660	-27.408	0.043	-65.246	-15.045	0.177	101.700
31	-11.817	0.257	-144.730	17.670	7.648	-159.020	-27.130	0.044	-92.100	-14.911	0.180	56.891
32	-12.588	0.235	-171.610	17.969	7.915	175.550	-26.768	0.046	-119.520	-14.657	0.185	6.430
33	-14.900	0.180	163.390	18.362	8.282	148.060	-26.185	0.049	-148.970	-13.556	0.210	-42.887
34	-21.159	0.088	161.170	18.588	8.500	118.310	-25.723	0.052	179.060	-12.691	0.232	-92.108
35	-20.309	0.097	-141.280	18.465	8.380	88.090	-25.559	0.053	145.960	-12.218	0.245	-138.540
36	-14.744	0.183	-158.220	18.201	8.130	59.059	-25.633	0.052	113.580	-13.056	0.222	-178.190
37	-12.538	0.236	170.230	18.066	8.004	30.963	-25.760	0.052	82.862	-14.378	0.191	143.400
38	-13.339	0.215	132.480	18.167	8.098	1.607	-25.749	0.052	52.499	-16.970	0.142	116.660
39	-15.011	0.178	78.005	18.276	8.200	-29.543	-25.454	0.053	20.356	-21.811	0.081	111.200
40	-16.105	0.157	6.891	18.189	8.118	-62.709	-25.424	0.054	-13.439	-20.840	0.091	134.530
41	-14.757	0.183	-61.000	17.917	7.868	-95.764	-25.415	0.054	-47.607	-16.035	0.158	118.260
42	-15.383	0.170	-108.170	17.784	7.748	-128.890	-25.467	0.053	-83.226	-15.120	0.175	80.564
43	-21.471	0.084	-141.240	17.922	7.872	-165.490	-25.277	0.054	-122.260	-16.069	0.157	25.234
44	-18.182	0.123	-72.748	17.442	7.449	151.790	-25.857	0.051	-166.580	-19.776	0.103	-75.636
45	-12.590	0.235	-105.520	15.750	6.130	110.450	-27.536	0.042	150.440	-14.233	0.194	-173.290
46	-13.269	0.217	-153.320	13.940	4.978	75.442	-29.470	0.034	112.520	-11.523	0.265	139.690
47	-20.284	0.097	126.900	12.983	4.458	40.022	-30.994	0.028	73.538	-10.251	0.307	102.000
48	-14.029	0.199	-5.310	11.793	3.887	-5.741	-33.295	0.022	27.040	-12.501	0.237	75.692
49	-9.656	0.329	-41.069	7.696	2.426	-50.048	-39.913	0.010	-10.430	-17.076	0.140	74.549
50	-5.683	0.520	-68.263	4.495	1.678	-69.558	-44.196	0.006	11.969	-12.434	0.239	98.012

Note:

1. Data obtained from on-wafer measurements.

AMMC-5024 Typical Performance (Over Temperature and Voltage)

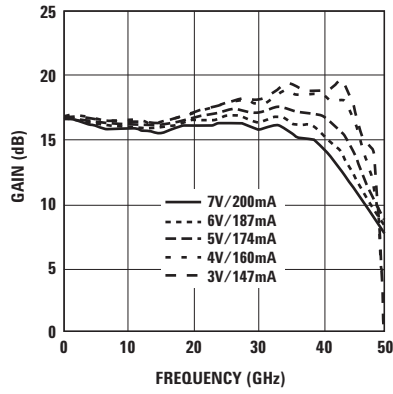

Figure 13. Gain and Voltage.

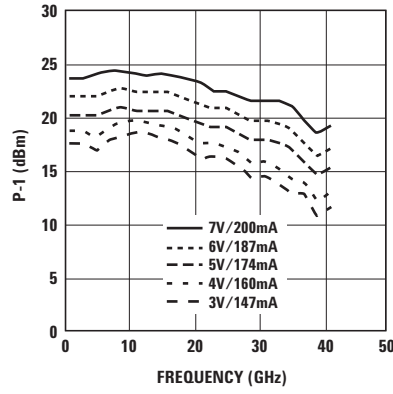

Figure 14. P-1 and Voltage.

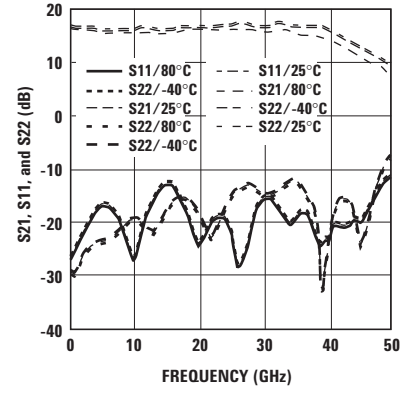

Figure 15. Gain and Return Loss with Temperature.

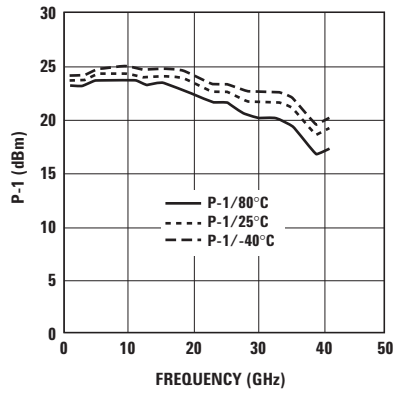

Figure 16. P-1 and Temperature, $V_{dd}=7V$, $I_{dd}=200$ mA.

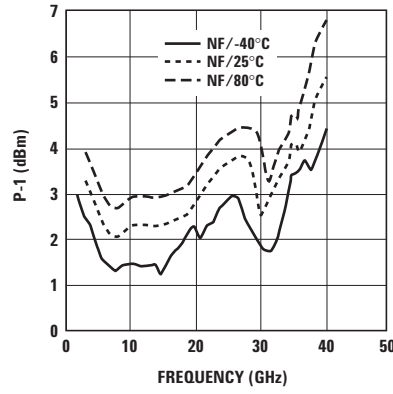

Figure 17. Noise Figure and Temperature at $V_{dd}=4V$, $I_{dd}=160$ mA.

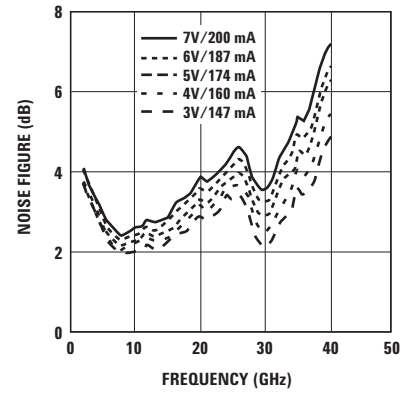

Figure 18. Noise Figure and Voltage.

Biasing and Operation

AMMC-5024 is biased with a single positive drain supply (V_{dd}) a negative gate supply (V_{g1}) and has a positive control gate supply (V_{g2}).

For best overall performance the recommended bias condition for the AMMC-5024 is $V_{dd}=7V$ and $I_{dd} = 200$ mA. To achieve this drain current level, V_{g1} is typically between -2.5 to $-3.5V$. Typically, DC current flow for V_{g1} is -10 mA. Open circuit is the default setting for V_{g2} when not utilizing gain control.

Using the simplest form of assembly (Figure 20), the device is capable of delivering flat gain over a 2–50 GHz range with a minimum of gain slope and ripple. However, this device is designed with DC coupled RF I/O ports, and operation may be extended to lower frequencies (<2 GHz) through the use of off-chip low-frequency extension circuitry and proper external biasing components. With low frequency bias extension it may be used in a variety of time-domain applications (through 40 Gb/s).

Figure 21 shows a typical assembly configuration.

When bypass capacitors are connected to the AUX pads, the low frequency limit is extended down to the corner frequency determined by the bypass capacitor and the combination of the on-chip 50 ohm load and small de-queing resistor. At this frequency the small signal gain will increase in magnitude and stay at this elevated level down to the point where the C_{aux} bypass capacitor acts as an open circuit, effectively rolling off the gain completely. The low frequency limit can be approximated from the following equation:

$$f_{C_{aux}} = \frac{1}{2\pi C_{aux}(R_o + R_{DEQ})}$$

where:

R_o is the 50Ω gate or drain line termination resistor.

R_{DEQ} is the small series de-queing resistor and 10Ω.

C_{aux} is the capacitance of the bypass capacitor connected to the AUX Drain and AUX Gate pad in farads.

With the external bypass capacitors connected to the AUX gate and AUX drain pads, gain will show a slight increase between 1.0 and 1.5 GHz. This is due to a series combination of C_{aux} and the on chip resistance but is exaggerated by the parasitic inductance (L_c) of the bypass capacitor and the inductance of the bond wire (L_d). Therefore the bond wire from the Aux pads to the bypass capacitors should be made as short as possible.

Input and output RF ports are DC coupled; therefore, DC decoupling capacitors are required if there are DC paths. (Do not attempt to apply bias to these pads.)

RF bond connections should be kept as short as possible to reduce RF lead inductance which will degrade performance above 20 GHz.

An optional output power detector network is also provided. Detector sensitivity is optimized by biasing the diodes with typical drain voltage $V_{dd} = 7$ volts. Simply connecting Det-Bias to the V_{dd} supply is a convenient method of biasing this detector network. The differential voltage between the Det-Ref and Det-Out pads can be correlated with the RF power emerging from the RF output port. A $>0.5 \mu F$ capacitor is required for the Det_Out pad to expand power detection performance below 100 MHz.

Ground connections are made with plated through-holes to the backside of the device; therefore, ground wires are not needed.

Assembly Techniques

The chip should be attached directly to the ground plane using either a fluxless AuSn solder preform or electrically conductive epoxy^[1]. For conductive epoxy, the amount should be just enough to provide a thin fillet around the bottom perimeter of the die. The ground plane should be free of any residue that may jeopardize electrical or mechanical attachment. Caution should be taken to not exceed the Absolute Maximum Rating for assembly temperature and time.

Thermosonic wedge bonding is the preferred method for wire attachment to the bond pads. The RF connections should be kept as short as possible to minimize inductance. Gold mesh^[2] or double-bonding with 0.7 mil gold wire is recommended.

Mesh can be attached using a 2 mil round tracking tool and a tool force of approximately 22 grams with an ultrasonic power of roughly 55 dB for a duration of 76 ± 8 mS. A guided wedge at an ultrasonic power level of 64 dB can be used for the 0.7 mil wire. The recommended wire bond stage temperature is $150 \pm 2^\circ C$.

The chip is 100 μm thick and should be handled with care.

This MMIC has exposed air bridges on the top surface. Handle at edges or with a custom collet (do not pick up die with vacuum on die center.)

This MMIC is also static sensitive and ESD handling precautions should be taken.

For more detailed information, see Avago Application Note 54 "GaAs MMIC ESD, Die Attach and Bonding Guidelines."

Notes:

1. Ablebond 84-1 LM1 silver epoxy is recommended.
2. Buckbee-Mears Corporation, St. Paul, MN, 800-262-3824

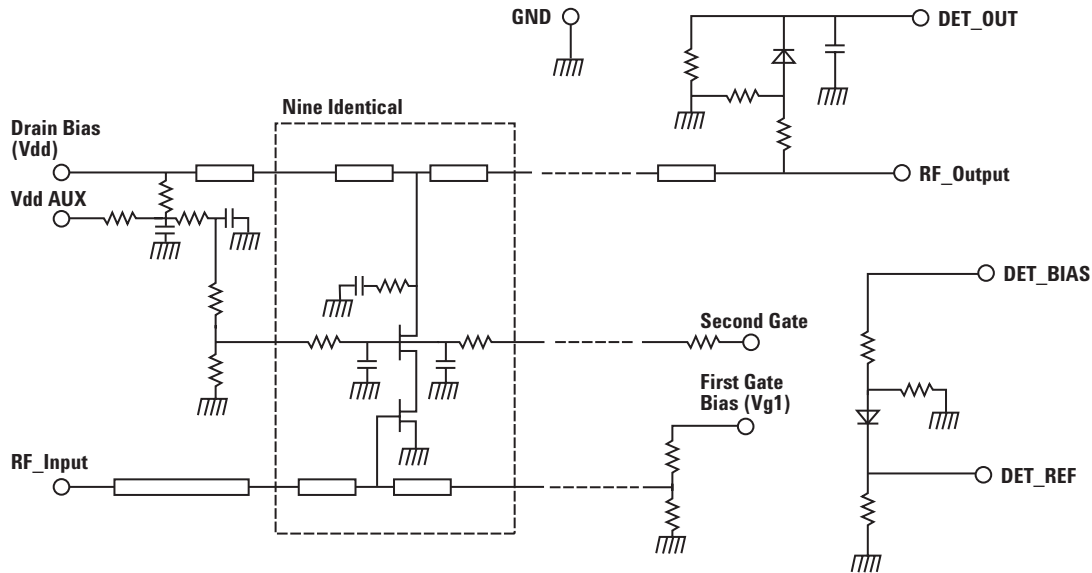

Figure 19. AMMC-5024 Schematic.

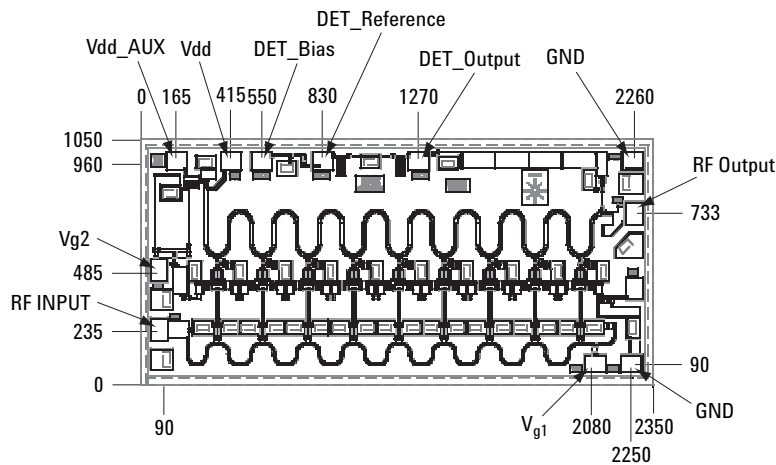

Figure 20. AMMC-5024 Bonding Pad Locations. (dimensions in micrometers)

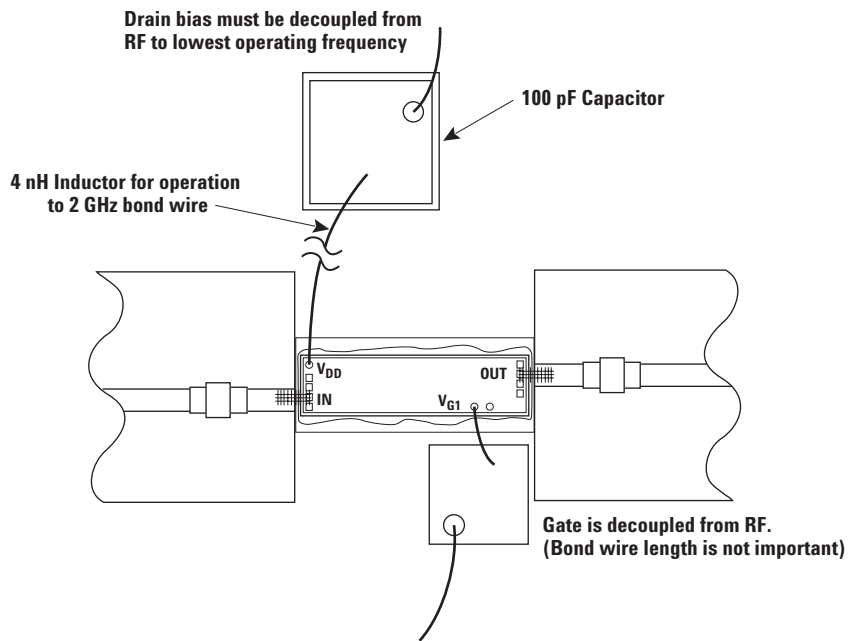

Figure 21. AMMC-5024 Assembly Diagram.

Ordering Information

AMMC-5024-W10 = 10 devices per tray

AMMC-5024-W50 = 50 devices per tray

For product information and a complete list of distributors, please go to our web site: www.avagotech.com

Avago, Avago Technologies, and the A logo are trademarks of Avago Technologies, Limited in the United States and other countries. Data subject to change. Copyright © 2006 Avago Technologies, Limited. All rights reserved. Obsoletes 5989-3931EN AV02-0632EN - September 11, 2007

Avago
TECHNOLOGIES