

PRECISION 2.45 VOLT VOLTAGE REFERENCE

ZR404

ISSUE 2 — FEBRUARY 1998

DEVICE DESCRIPTION

The ZR404 uses a bandgap circuit design to achieve a precision voltage reference of 2.45 volts. The device is available in small outline surface mount packages, ideal for applications where space saving is important as well as a 2 pin TO92 style package for through hole requirements.

The ZR404 design provides a stable voltage without an external capacitor and is stable with capacitive loads. The ZR404 is recommended for operation between 2mA and 120mA.

FEATURES

- Small outline SO8 and TO92 style packages
- No stabilising capacitor required
- Typical T_c 15ppm/°C
- Typical slope resistance 0.26Ω
- ± 3% tolerance
- Industrial temperature range (Military temperature range available on request)
- Operating current 2mA to 120mA
- Alternative package options and tolerances are available

APPLICATIONS

- Battery powered and portable equipment.
- Metering and measurement systems.
- Instrumentation.
- Test equipment.
- Data acquisition systems.
- Precision power supplies.

SCHEMATIC DIAGRAM

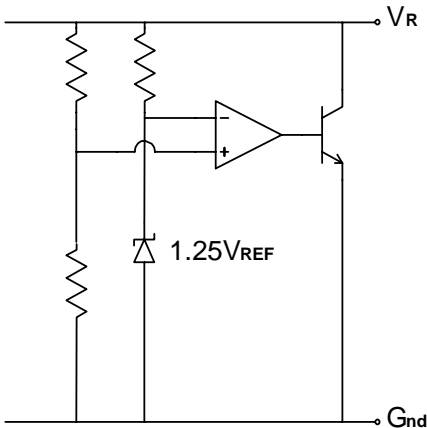

ZR404

ABSOLUTE MAXIMUM RATING

Reverse Current	200mA
Forward Current	25mA
Operating Temperature	-40 to 85°C
Storage Temperature	-55 to 125°C

Power Dissipation (T_{amb}=25°C)

E-Line, 2 pin (TO92)	500mW
SO8	625mW

ELECTRICAL CHARACTERISTICS

TEST CONDITIONS (Unless otherwise stated) T_{amb}=25°C

SYMBOL	PARAMETER	CONDITIONS	LIMITS			TOL. %	UNITS
			MIN	TYP	MAX		
V _R	Reverse Breakdown Voltage	I _R =5mA	2.38	2.45	2.52	3	V
I _{MIN}	Minimum Operating Current				2		mA
I _R	Recommended Operating Current		2		120		mA
T _C †	Average Reverse Breakdown Voltage Temp. Co.	I _{R(min)} to I _{R(max)}		15	50		ppm/°C
R _S §	Slope Resistance			0.26	0.5		Ω
Z _R	Reverse Dynamic Impedance	I _R = 5mA f = 100Hz I _{AC} =0.1 I _R		0.28	1		Ω
E _N	Wideband Noise Voltage	I _R = 5mA f = 10Hz to 10kHz		65			μV(rms)

$$\dagger T_C = \frac{(V_{R(max)} - V_{R(min)}) \times 1000000}{V_R \times (T_{(max)} - T_{(min)})}$$

Note: V_{R(max)} - V_{R(min)} is the maximum deviation in reference voltage measured over the full operating temperature range.

$$\S R_S = \frac{V_R \text{ Change}(I_R(\text{min}) \text{ to } I_R(\text{max}))}{I_R(\text{max}) - I_R(\text{min})}$$

ZR404

TYPICAL CHARACTERISTICS

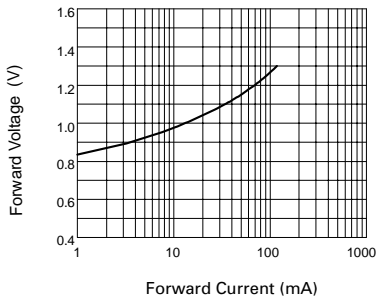

Forward Characteristics

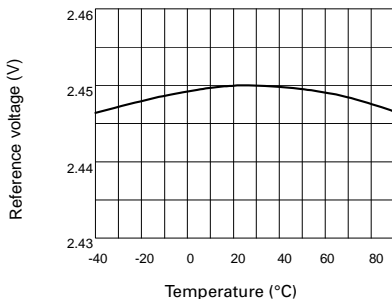

Temperature Drift

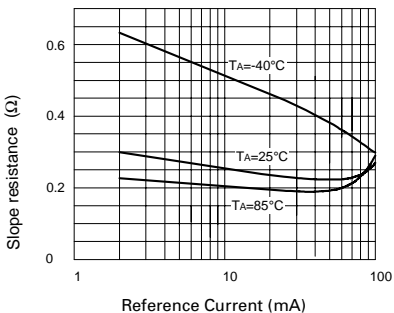

Slope Resistance v Current

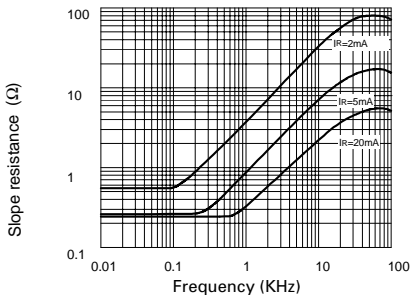

Slope Resistance v Frequency

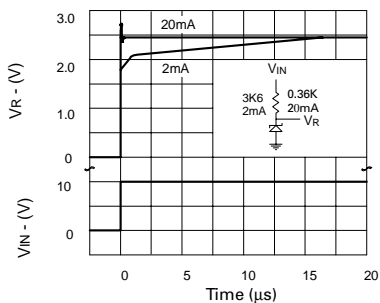

Transient Response

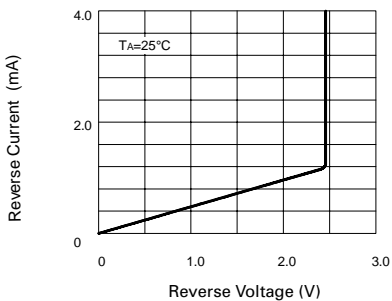

Reverse Characteristics

ZR404

CONNECTION DIAGRAMS

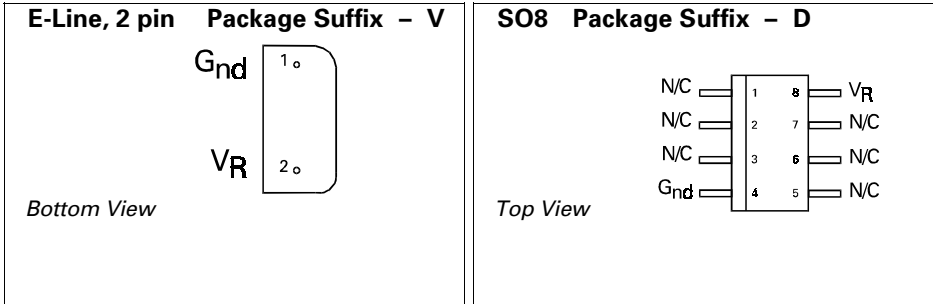

ORDERING INFORMATION

Part No	Tol%	Package	Partmark
ZR404	3	E-Line †	ZR404
ZR404D	3	SO8	ZR404

† E-Line 2 pin