

Bias Resistor Transistor PNP Silicon

 Lead(Pb)-Free

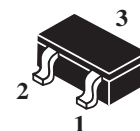
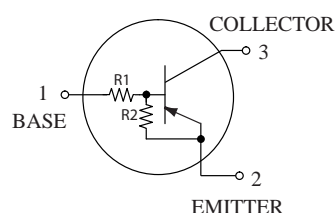

SC-59

Maximum Ratings (T_A=25°C unless otherwise noted)

Rating	Symbol	Value	Unit
Collector-Emitter Voltage	V _{CEO}	50	Vdc
Collector-Base Voltage	V _{CBO}	50	Vdc
Collector Current-Continuous	I _C	100	mAdc

Thermal Characteristics

Characteristics	Symbol	Max	Unit
Total Device Dissipation FR-5 Board ⁽¹⁾ (1)T _A =25°C Derate above 25°C	P _D	230 1.8	mW mW/°C
Thermal Resistance, Junction to Ambient ⁽¹⁾	R _{θJA}	540	°C/W
Junction and Storage, Temperature Range	T _J ,T _{stg}	-55 to +150	°C

1.FR-4 @ minimum pad

Device Marking and Resistor Values

Device	Marking	R1(K)	R2(K)	Device	Marking	R1(K)	R2(K)
MUN2111	6A	10	10	MUN2131	6H	2.2	2.2
MUN2112	6B	22	22	MUN2132	6J	4.7	4.7
MUN2113	6C	47	47	MUN2133	6K	4.7	47
MUN2114	6D	10	47	MUN2134	6L	22	47
MUN2115	6E	10	∞	MUN2136	6N	100	100
MUN2116	6F	4.7	∞	MUN2137	6P	47	22
MUN2130	6G	1.0	1.0	MUN2140	6T	47	∞

Electrical Characteristics (TA=25°C Unless Otherwise noted)

Characteristics	Symbol	Min	Typ	Max	Unit
-----------------	--------	-----	-----	-----	------

Off Characteristics

Collector-Emitter Breakdown Voltage (2) ($I_C=2.0\text{mA}$, $I_B=0$)	V(BR)CEO	50	-	-	V
Collector-Base Breakdown Voltage ($I_C=10\text{ }\mu\text{A}$, $I_E=0$)	V(BR)CBO	50	-	-	V
Collector-Base Cutoff Voltage ($V_{CB}=50\text{V}$, $I_E=0$)	ICBO	-	-	100	nA
Collector-Emitter Cutoff Current ($V_{CE}=50\text{V}$, $I_B=0$)	ICEO	-	-	500	nA
Emitter-Base Cutoff Current ($V_{EB}=6.0\text{V}$, $I_C=0$)	IEBO	-	-	0.5	mA
MUN2111		-	-	0.2	
MUN2112		-	-	0.1	
MUN2113		-	-	0.2	
MUN2114		-	-	0.9	
MUN2115		-	-	1.9	
MUN2116		-	-	4.3	
MUN2130		-	-	2.3	
MUN2131		-	-	1.5	
MUN2132		-	-	0.18	
MUN2133		-	-	0.13	
MUN2134		-	-	0.05	
MUN2136		-	-	0.13	
MUN2137		-	-	0.20	
MUN2140		-	-		

On Characteristics

Collector-Emitter Saturation Voltage ($I_C=10\text{mA}$, $I_B=0.3\text{mA}$)	VCE(sat)	-	-	0.25	Vdc
MUN2111		-	-	0.25	
MUN2112		-	-	0.25	
MUN2113		-	-	0.25	
MUN2114		-	-	0.25	
MUN2115		-	-	0.25	
MUN2130		-	-	0.25	
MUN2136		-	-	0.25	
MUN2137		-	-	0.25	
($I_C=10\text{mA}$, $I_B=5\text{mA}$) ($I_C=10\text{mA}$, $I_B=1\text{mA}$)		-	-	0.25	
MUN2131		-	-	0.25	
MUN2116		-	-	0.25	
MUN2132		-	-	0.25	
MUN2134		-	-	0.25	
MUN2140		-	-	0.25	

2. Pulse Test: Pulse Width < 300 us, Duty Cycle < 2.0%

Electrical Characteristics (TA=25°C Unless Otherwise noted)

Characteristics	Symbol	Min	Typ	Max	Unit
-----------------	--------	-----	-----	-----	------

On Characteristics (2)

DC Current Gain (VCE=-10V, IC=-5.0mA)	MUN2111	h _{FE}	35	60	-		
	MUN2112		60	100	-		
	MUN2113		80	140	-		
	MUN2114		80	140	-		
	MUN2115		160	250	-		
	MUN2116		160	250	-		
	MUN2130		3.0	5.0	-		
	MUN2131		8.0	15	-		
	MUN2132		15	27	-		
	MUN2133		80	140	-		
	MUN2134		80	130	-		
	MUN2136		80	150	-		
	MUN2137		80	140	-		
	MUN2140		120	250	-		
Output Voltage(on) (V _{CC} =5.0V, V _B =2.5V, R _L =1.0kΩ)	MUN2111	V _{OL}	-	-	0.2	Vdc	
	MUN2112		-	-	0.2		
	MUN2114		-	-	0.2		
	MUN2115		-	-	0.2		
	MUN2116		-	-	0.2		
	MUN2130		-	-	0.2		
	MUN2131		-	-	0.2		
	MUN2132		-	-	0.2		
	MUN2133		-	-	0.2		
	MUN2134		-	-	0.2		
	(V _{CC} =5.0V, V _B =3.5V, R _L =1.0kΩ)		MUN2113	-	-		0.2
	MUN2140		-	-	0.2		
	(V _{CC} =5.0V, V _B =5.5V, R _L =1.0kΩ)		MUN2136	-	-		0.2
(V _{CC} =5.0V, V _B =4.0V, R _L =1.0kΩ)	MUN2137	-	-	0.2			
Output Voltage(off) (V _{CC} =5.0V, V _B =0.5V, R _L =1.0kΩ) (V _{CC} =5.0V, V _B =0.05V, R _L =1.0kΩ) (V _{CC} =5.0V, V _B =0.25V, R _L =1.0kΩ)	MUN2130	V _{OH}	4.9	-	-	Vdc	
	MUN2115						
	MUN2116						
	MUN2131						
	MUN2132						
MUN2140							

2. Pulse Test: Pulse Width<300 us, Duty Cycle<2.0%

Electrical Characteristics (TA=25°C Unless Otherwise noted)

Characteristics	Symbol	Min	Typ	Max	Unit
-----------------	--------	-----	-----	-----	------

On Characteristics (2)

Input Resistor	MUN2111	R1	7.0	10	13	kΩ
	MUN2112		15.4	22	28.6	
	MUN2113		32.9	47	61.1	
	MUN2114		7.0	10	13	
	MUN2115		7.0	10	13	
	MUN2116		3.3	4.7	6.1	
	MUN2130		0.7	1.0	1.3	
	MUN2131		1.5	2.2	2.9	
	MUN2132		3.3	4.7	6.1	
	MUN2133		3.3	4.7	6.1	
	MUN2134		15.4	22	28.6	
	MUN2136		70	100	130	
	MUN2137		32.9	47	61.1	
	MUN2140		32.9	47	61.1	
	Resistor Ratio MUN2111/MUN2112/MUN2113		R1/R2	0.8	1.0	
MUN2136	0.17	0.21		0.25		
MUN2114	-	-		-		
MUN2115/MUN2116/MUN2140	0.8	1.0		1.2		
MUN2130/MUN2131/MUN2132	0.055	0.1		0.185		
MUN2133	0.38	0.47		0.56		
MUN2134	1.7	2.1		2.6		
MUN2137						

2. Pulse Test: Pulse Width < 300 us, Duty Cycle < 2.0 %

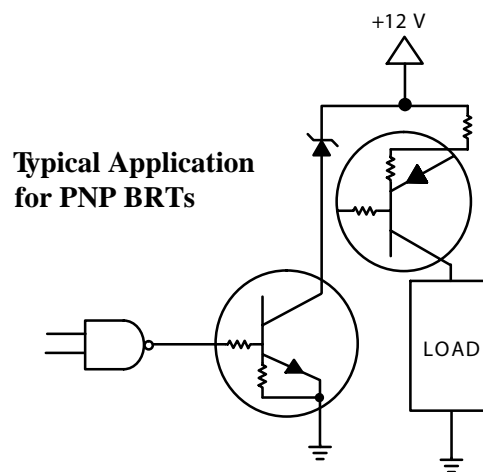
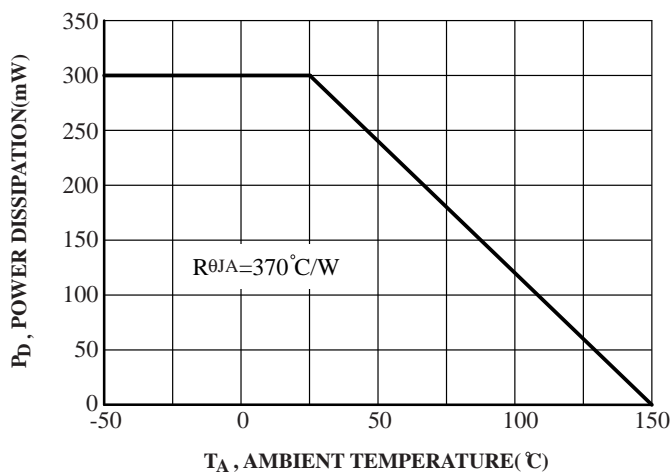
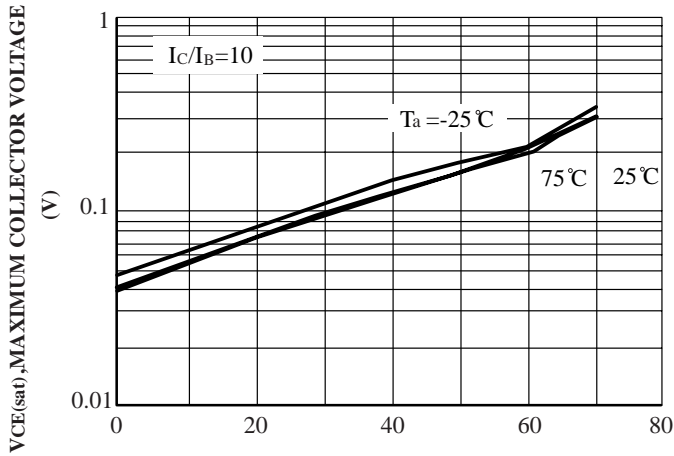

FIG.2 Inexpensive, Unregulated Current Source

MUN2111 Series

TYPICAL ELECTRICAL CHARACTERISTICS-MUN2111



I_C , COLLECTOR CURRENT(mA)

FIG.3 $V_{CE(sat)}$ vs. I_C

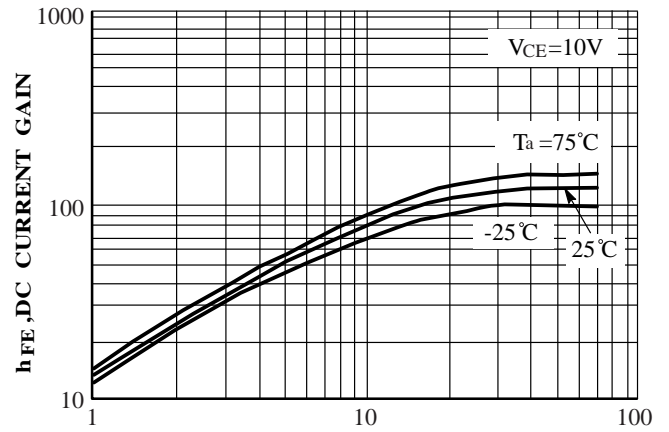

I_C , COLLECTOR CURRENT(mA)

FIG.4 DC Current Gain

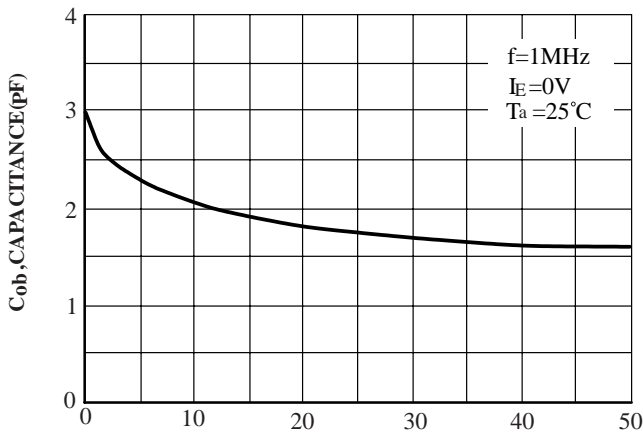

V_R , REVERSE BIAS VOLTAGE(V)

FIG.5 Output Capacitance

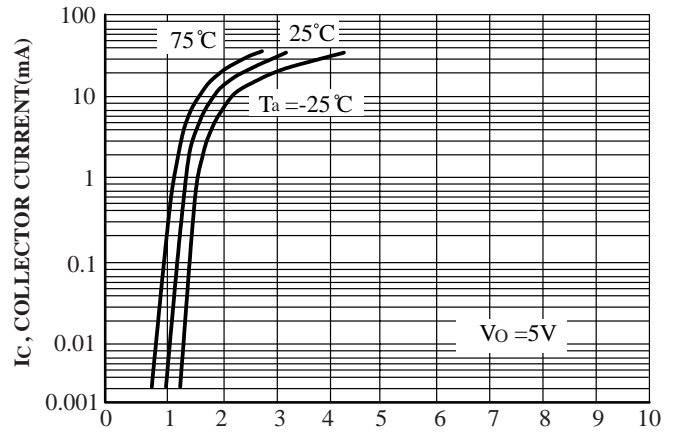

V_{in} , INPUT VOLTAGE(V)

FIG.6 Output Current vs. Input Voltage

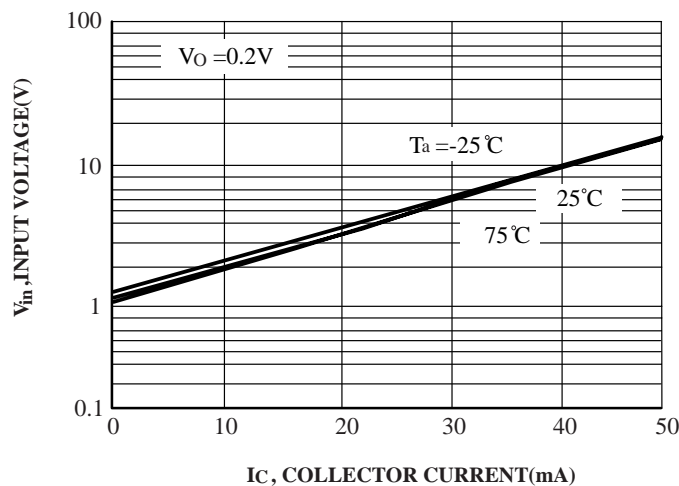

I_C , COLLECTOR CURRENT(mA)

FIG.7 Input Voltage vs. Output Current

MUN2111 Series

TYPICAL ELECTRICAL CHARACTERISTICS-MUN2112

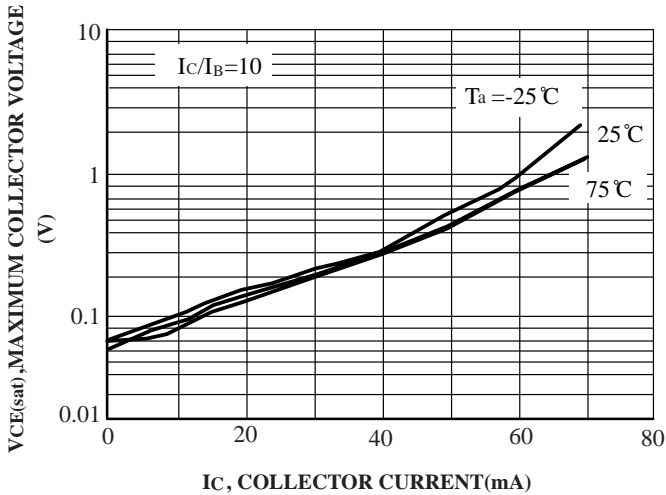

FIG.8 $V_{CE(sat)}$ vs. I_C

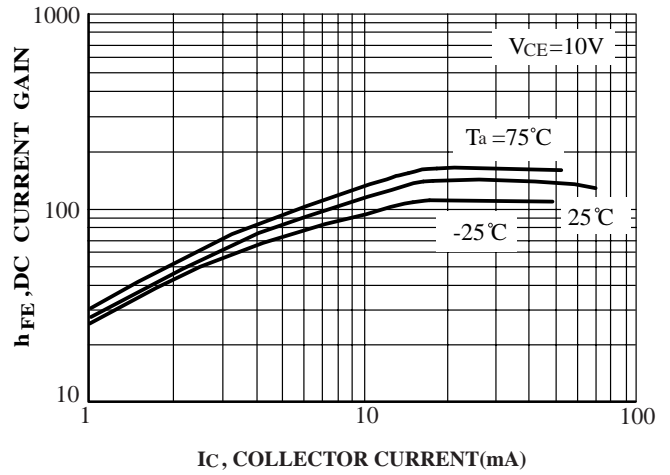

FIG.9 DC Current Gain

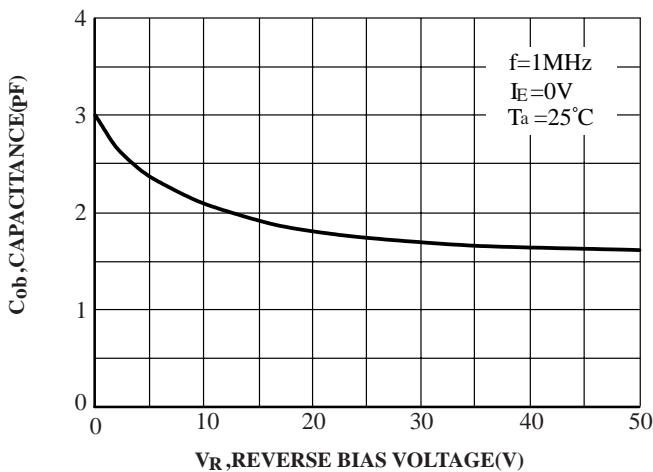

FIG.10 Output Capacitance

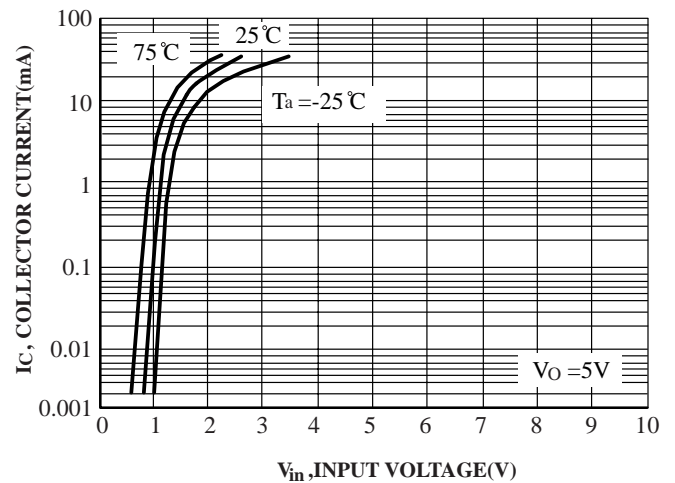

FIG.11 Output Current vs. Input Voltage

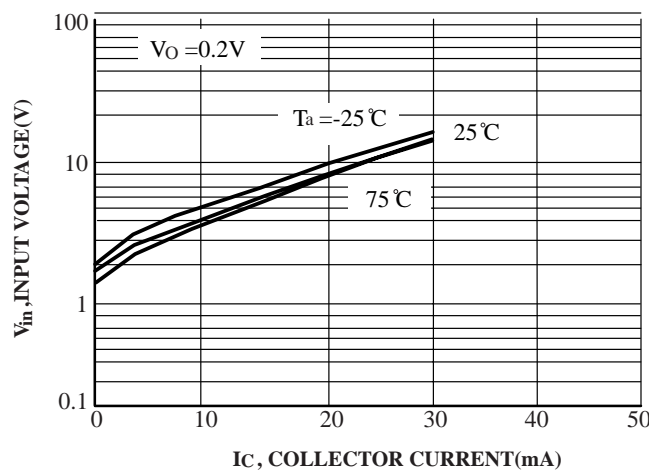
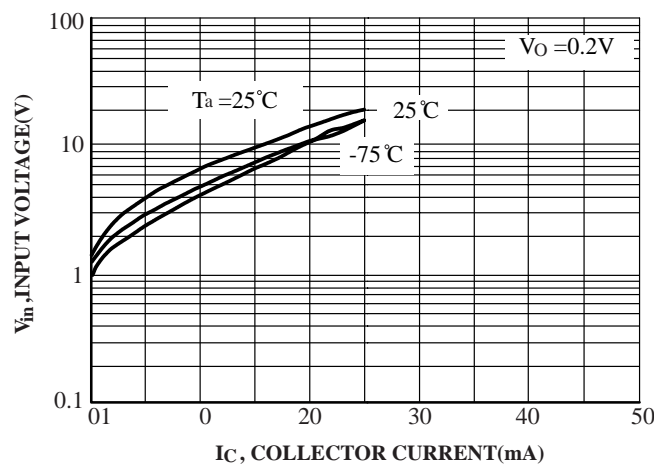
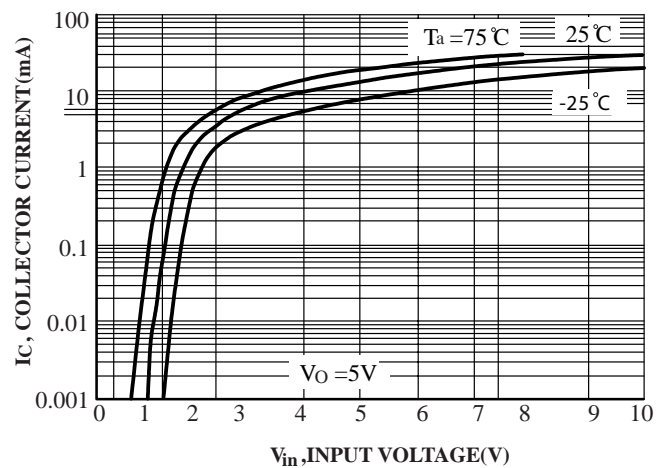
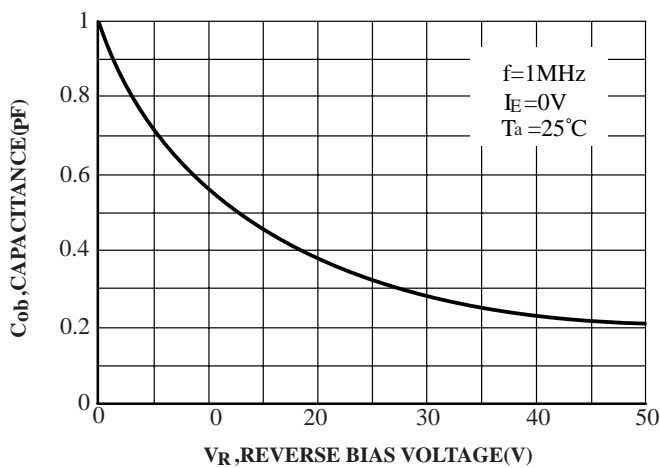
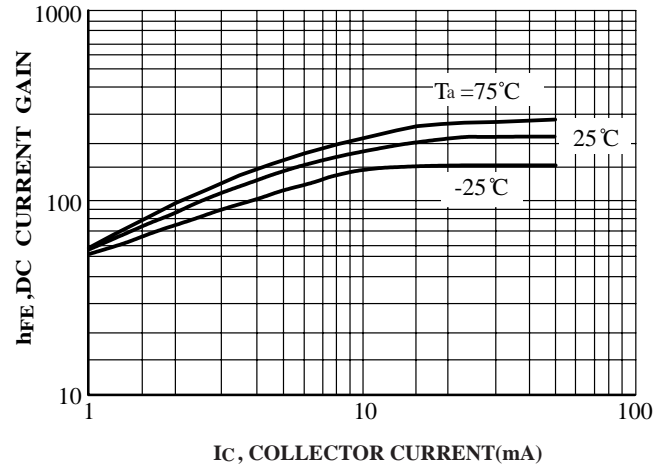
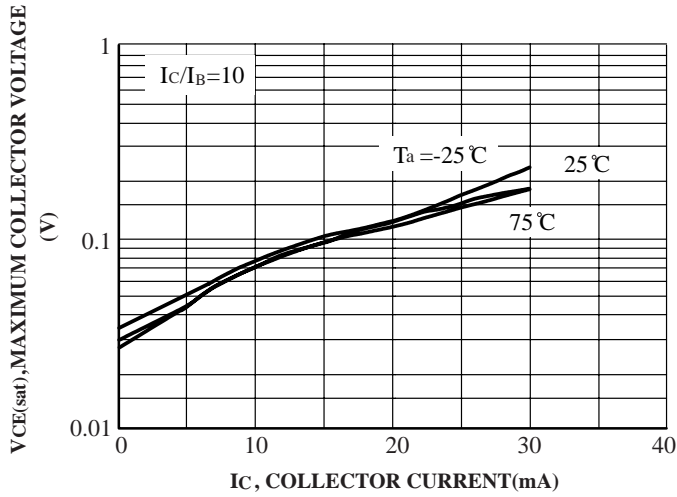

FIG.12 Input Voltage vs. Output Current

MUN2111 Series

TYPICAL ELECTRICAL CHARACTERISTICS-MUN2113



MUN2111 Series

TYPICAL ELECTRICAL CHARACTERISTICS-MUN2114

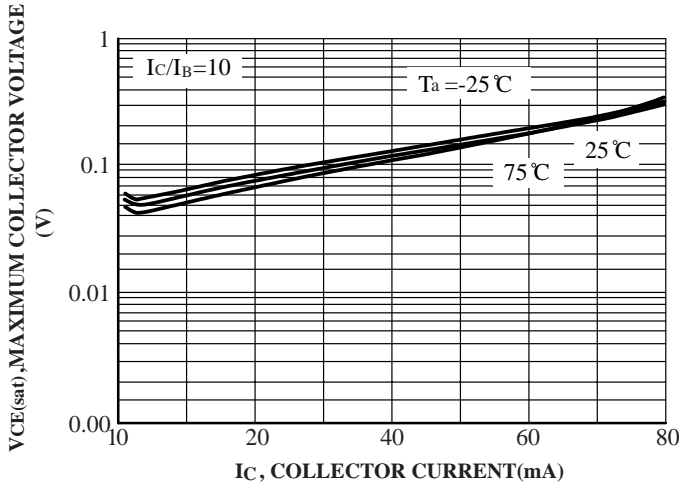

FIG.18 $V_{CE(sat)}$ vs. I_C

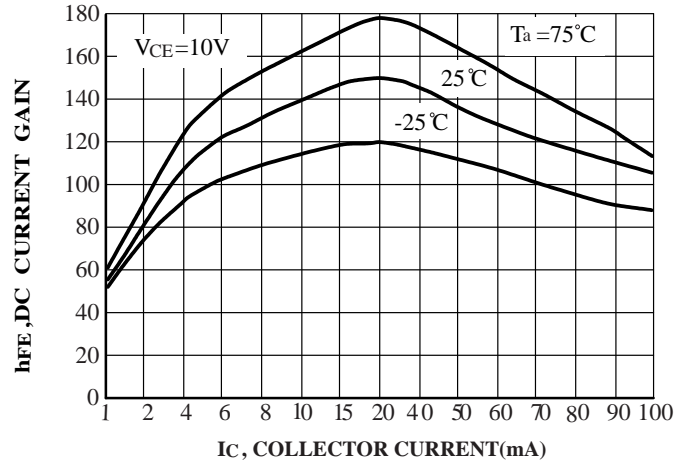

FIG.19 DC Current Gain

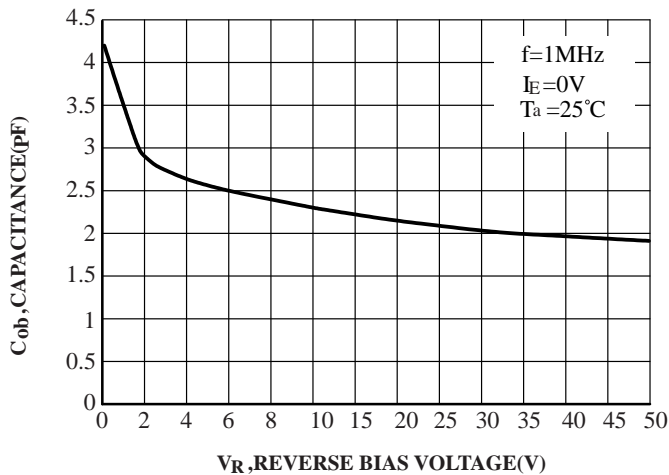

FIG.20 Output Capacitance

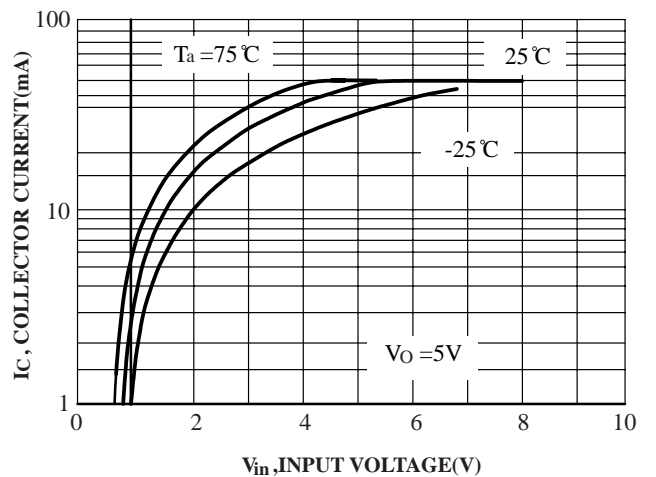

FIG.21 Output Current vs. Input Voltage

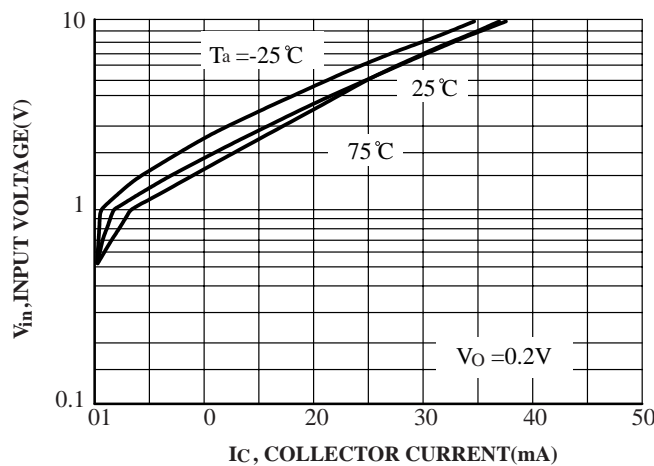

FIG.22 Input Voltage vs. Output Current

MUN2111 Series

TYPICAL ELECTRICAL CHARACTERISTICS-MUN2131

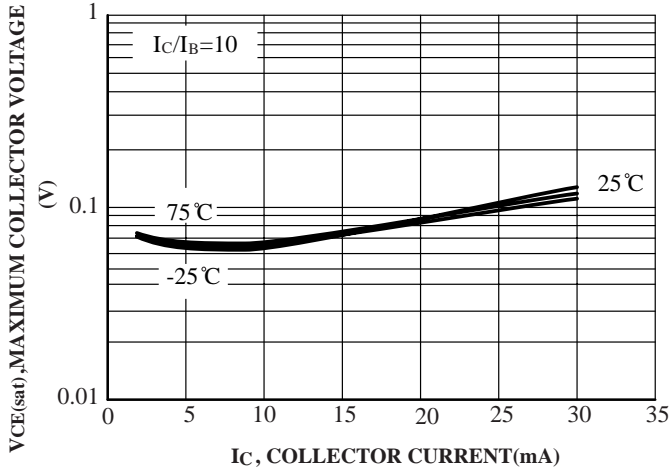

FIG.23 $V_{CE(sat)}$ vs. I_C

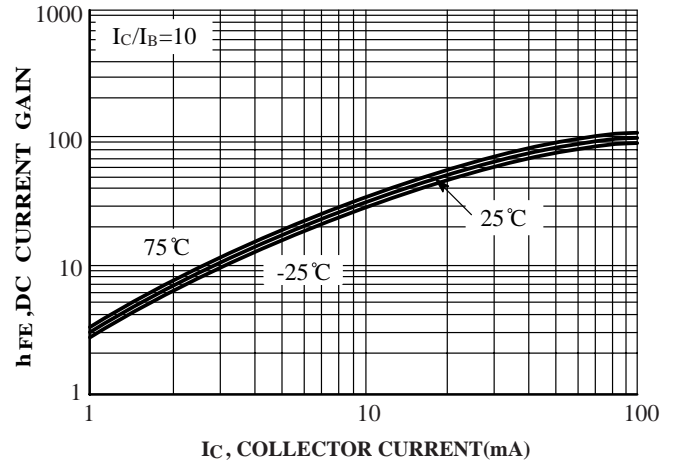

FIG.24 DC Current Gain

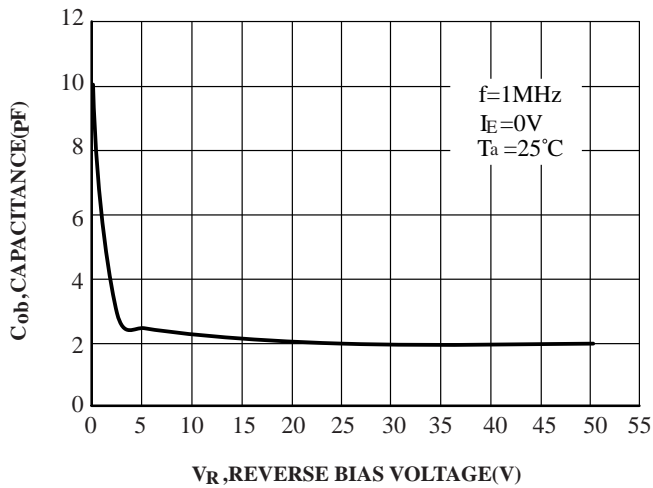

FIG.25 Output Capacitance

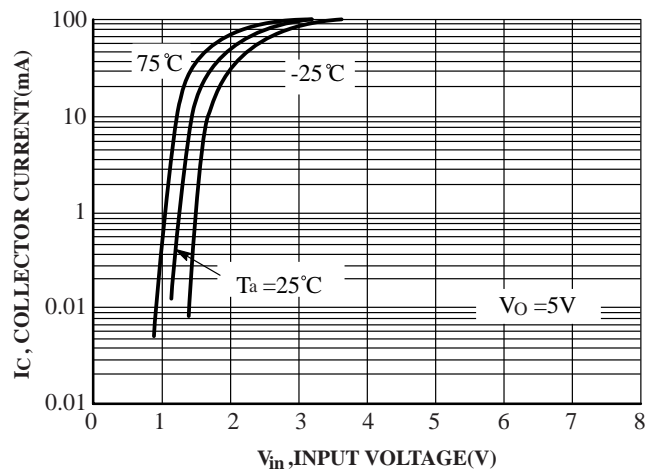

FIG.26 Output Current vs. Input Voltage

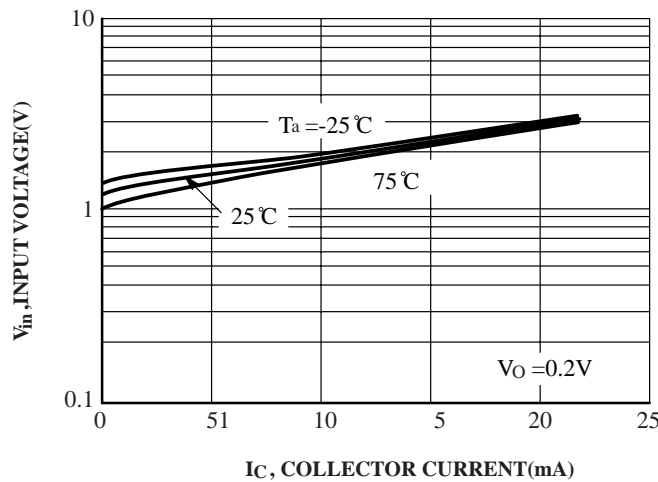

FIG.27 Input Voltage vs. Output Current

MUN2111 Series

TYPICAL ELECTRICAL CHARACTERISTICS-MUN2136

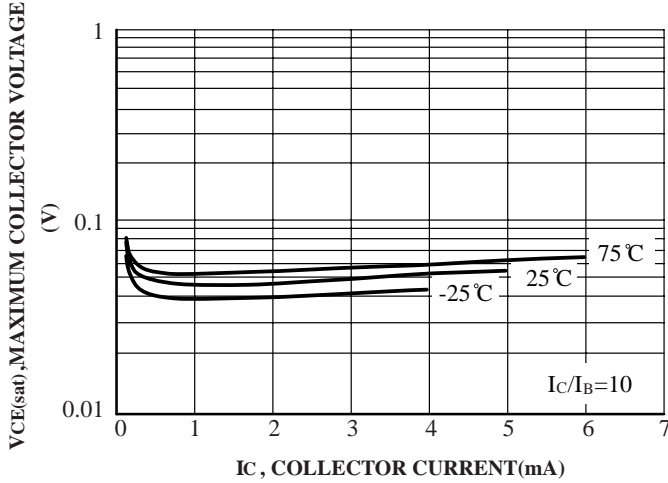

FIG.28 Maximum Collector Voltage versus Collector Current

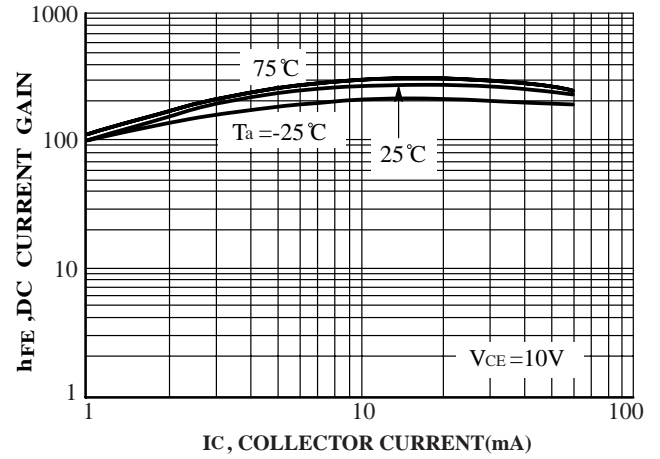

FIG.29 DC Current Gain

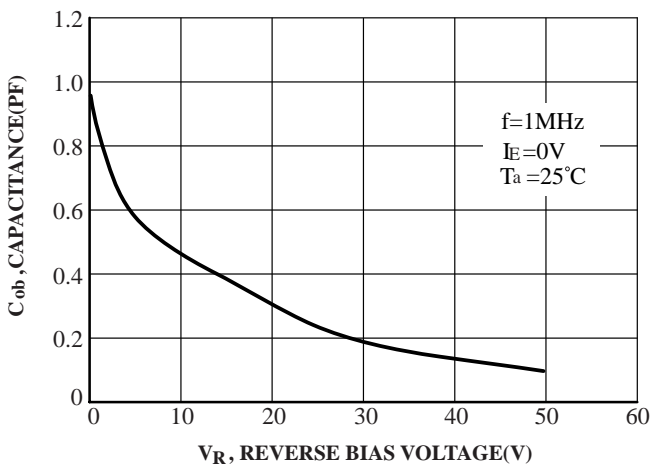

FIG.30 Output Capacitance

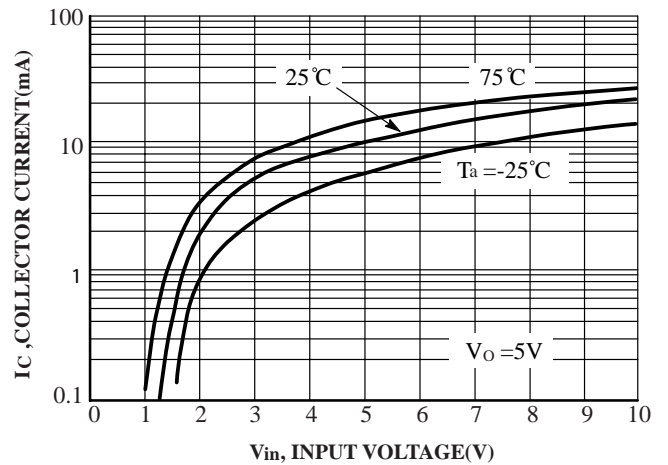

FIG.31 Output Current Versus Input Voltage

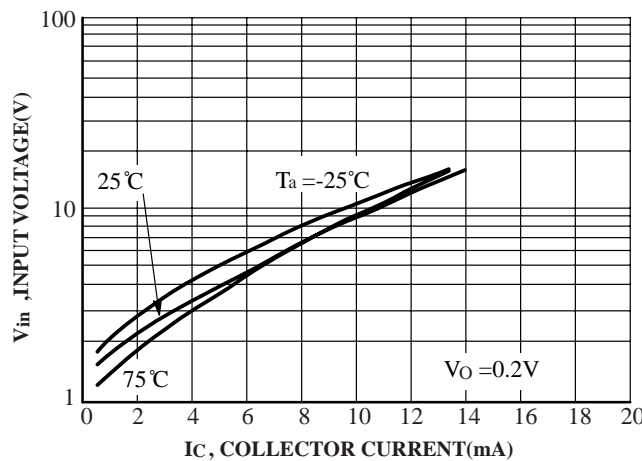

FIG.32 Input Voltage Versus Output Current

MUN2111 Series

TYPICAL ELECTRICAL CHARACTERISTICS-MUN2137

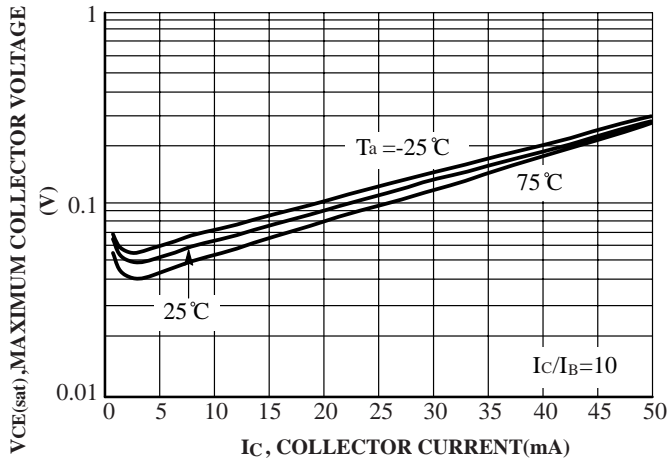

FIG.33 Maximum Collector Voltage Versus Collector Current

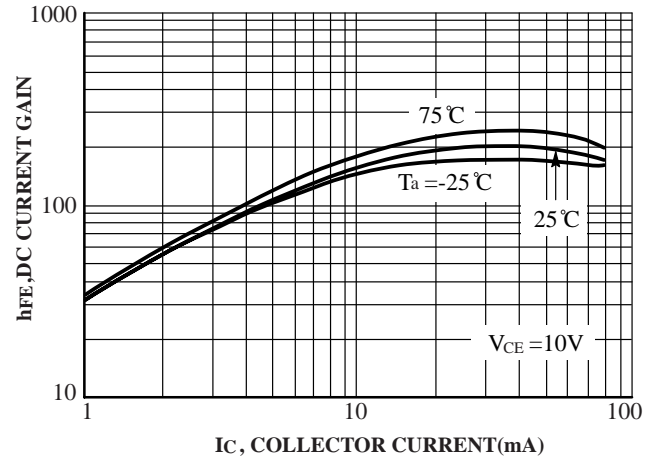

FIG.34 DC Current Gain

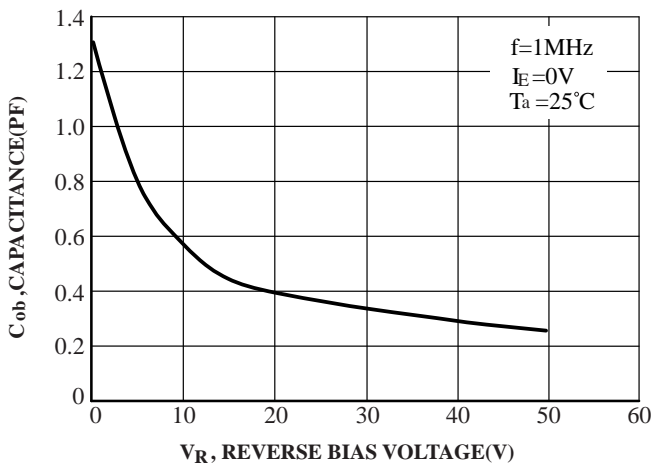

FIG.35 Output Capacitance

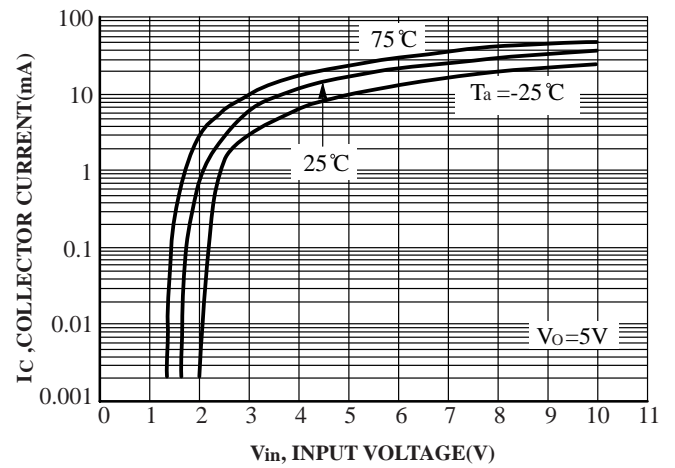

FIG.36 Output Current Versus Input Voltage

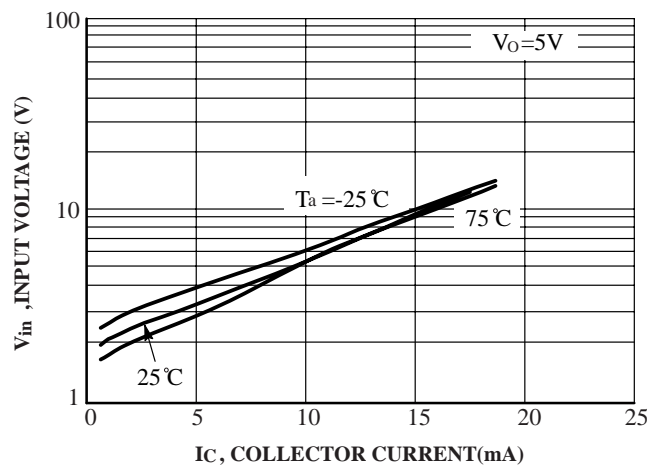
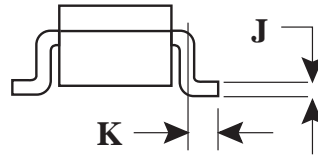
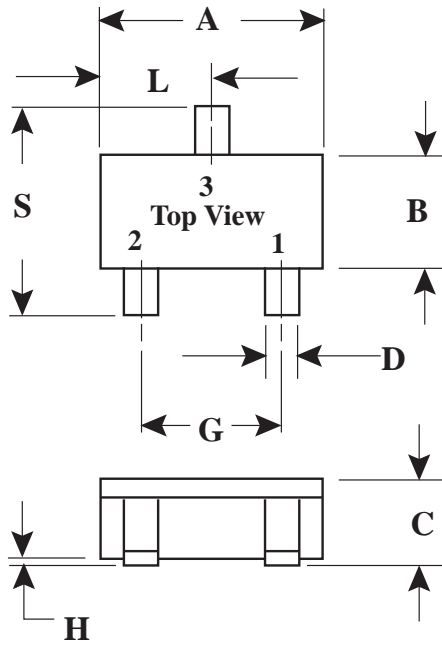

FIG.37 Input Voltage Versus Output Current

SC-59 Outline Dimension



SC-59		
Dim	Min	Max
A	2.70	3.10
B	1.30	1.70
C	1.00	1.30
D	0.35	0.50
G	1.70	2.30
H	0.00	0.10
J	0.10	0.26
K	0.20	0.60
L	1.25	1.65
S	2.25	3.00
All Dimension in mm		