

SI-8000JF Series

Full-Mold, Separate Excitation Switching Type

■Features

- Compact full-mold package (equivalent to TO220)
- Output current: 1.5 A
- High efficiency: 79 to 91%
- Requires only 4 external components
- Phase correction and output voltage adjustment performed internally
- Choke coil size can be reduced through the employment of high frequency (125 kHz) design
- Built-in foldback overcurrent protection, thermal protection circuits
- Output ON/OFF capable (OFF state current consumption: 200 μ A max.)
- Soft start possible via ON/OFF pin

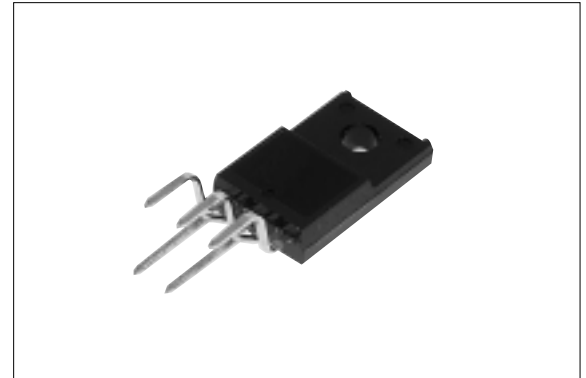

■Applications

- Power supplies for telecommunication equipment
- Onboard local power supplies

■Lineup

Part Number	SI-8015JF	SI-8025JF	SI-8033JF	SI-8050JF	SI-8090JF	SI-8120JF
V_o (V)	1.59	2.5	3.3	5.0	9.0	12.0
I_o (A)	1.5					

■Absolute Maximum Ratings

Parameter	Symbol	Ratings	Unit
DC Input Voltage	V_{IN}	43	V
Power Dissipation	P_{D1}	16.6 (with infinite heatsink)	W
	P_{D2}	1.5 (without heatsink, standalone operation)	W
Junction Temperature	T_j	+125	$^{\circ}$ C
Storage Temperature	T_{stg}	-40 to +125	$^{\circ}$ C
Thermal Resistance (Junction to Case)	$R_{th(j-c)}$	6.0	$^{\circ}$ C/W

■Recommended Operating Conditions

Parameter	Symbol	Ratings						Unit	Conditions
		SI-8015JF*	SI-8025JF	SI-8033JF	SI-8050JF	SI-8090JF	SI-8120JF		
DC Input Voltage Range	V_{IN1}	V_o+2 to V_o+3	4.5 to 5.5	5.3 to 6.3	7 to 8	11 to 12	14 to 15	V	$I_o=0$ to 1A
	V_{IN2}	V_o+3 to 40	5.5 to 40	6.3 to 40	8 to 40	12 to 40	15 to 40	V	$I_o=0$ to 1.5A
Output Current Range	I_o	0 to 1.5						A	$V_{IN} \geq V_o+3V$
Operating Junction Temperature Range	T_{jop}	-30 to +125						$^{\circ}$ C	

*SI-8015JF is a variable output voltage type. The variable output voltage range is from 2.5 V to 24 V.

■Electrical Characteristics

(Ta=25°C)

Parameter	Symbol	Rating															Unit			
		SI-8015JF			SI-8025JF			SI-8033JF			SI-8050JF			SI-8090JF				SI-8120JF		
		min.	typ.	max.	min.	typ.	max.	min.	typ.	max.	min.	typ.	max.	min.	typ.	max.		min.	typ.	max.
Output Voltage*1	Vo ²	1.558	1.59	1.622	2.45	2.50	2.55	3.234	3.30	3.366	4.90	5.00	5.10	8.82	9.00	9.18	11.76	12.00	12.24	V
	Conditions	VIN=12V, Io=0.5A			VIN=12V, Io=0.5A			VIN=15V, Io=0.5A			VIN=20V, Io=0.5A			VIN=21V, Io=0.5A			VIN=24V, Io=0.5A			
Efficiency	η		67			74			77			82			86			88		%
	Conditions	VIN=12V, Io=0.5A			VIN=12V, Io=0.5A			VIN=15V, Io=0.5A			VIN=20V, Io=0.5A			VIN=21V, Io=0.5A			VIN=24V, Io=0.5A			
Switching Frequency	f		125			125			125			125			125			125		kHz
	Conditions	VIN=12V, Io=0.5A			VIN=12V, Io=0.5A			VIN=15V, Io=0.5A			VIN=20V, Io=0.5A			VIN=21V, Io=0.5A			VIN=24V, Io=0.5A			
Line Regulation	ΔV _{OLINE}		25	80		25	80		25	80		40	100		50	120		60	130	mV
	Conditions	VIN=8 to 30V, Io=0.5A			VIN=7 to 30V, Io=0.5A			VIN=8 to 30V, Io=1.0A			VIN=10 to 30V, Io=1.0A			VIN=15 to 30V, Io=1.0A			VIN=18 to 30V, Io=1.0A			
Load Regulation	ΔV _{OLOAD}		10	30		10	30		10	30		10	40		10	40		10	40	mV
	Conditions	VIN=12V, Io=0.2 to 0.8A			VIN=12V, Io=0.2 to 0.8A			VIN=15V, Io=0.5 to 1.5A			VIN=20V, Io=0.5 to 1.5A			VIN=21V, Io=0.5 to 1.5A			VIN=24V, Io=0.5 to 1.5A			
Temperature Coefficient of Output Voltage ³	ΔVo/ΔTa ⁴		±0.5			±0.5			±1.0			±1.0								mV/°C
Overcurrent Protection Starting Current	Is1	1.6			1.6			1.6			1.6			1.6			1.6			A
ON/OFF ⁵ Terminal	Low Level Voltage	VSSL		0.5		0.5		0.5		0.5		0.5		0.5		0.5		0.5		V
	Leak Current at Low Voltage	ISSL		100		100		100		100		100		100		100		100		μA
	Conditions	VSSL=0V			VSSL=0V			VSSL=0V			VSSL=0V			VSSL=0V			VSSL=0V			
Quiescent Circuit Current	Iq		7			7		7		7		7		7		7		7		mA
	Conditions	VIN=12V, Io=0A			VIN=12V, Io=0A			VIN=15V, Io=0A			VIN=20V, Io=0A			VIN=21V, Io=0A			VIN=24V, Io=0A			
	Iq(off)		200			200		200		200		200		200		200		200		μA
Conditions	VIN=12V, VONOFF=0.3V			VIN=12V, VONOFF=0.3V			VIN=15V, VONOFF=0.3V			VIN=20V, VONOFF=0.3V			VIN=21V, VONOFF=0.3V			VIN=24V, VONOFF=0.3V				

*1: Reference voltage for SI-8015JF

*3: Reference voltage temperature coefficient for SI-8015JF

*2: VREF for SI-8015JF

*4: ΔVREF/ΔTa for SI-8015JF

*5: Pin 5 is the ON/OFF pin. Connecting a capacitor to this pin enables the soft start function. By using this pin, the output can also be turned on or off.

To stop output, set the ON/OFF pin voltage to VSSL or less. To switch the potential of the ON/OFF pin, drive the open collector of the transistor, etc. When SI-8000JF is started using the ON/OFF pin, take appropriate action such as limiting the current for a large-capacity C3 because a discharge current flows to the ON/OFF control transistor from C3. The ON/OFF pin is pulled up to the power supply in the IC, so no external voltage can be applied. If this pin is not used, leave it open.

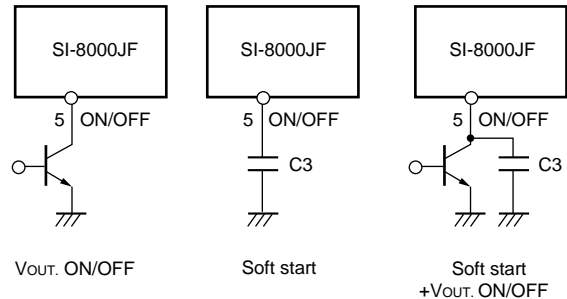

■External Dimensions

(Unit : mm)

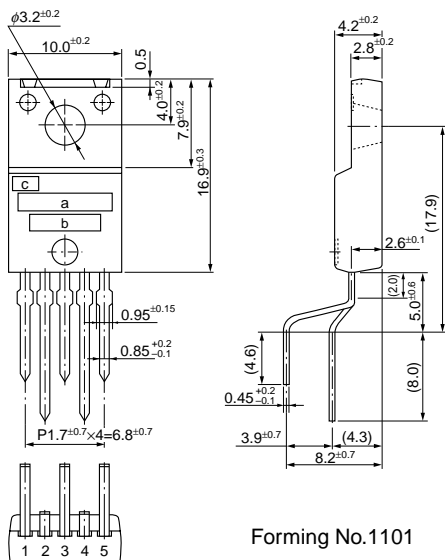

- a. Part Number
- b. Lot Number
- c. Logo Mark

Pin Arrangement

- ① VIN
- ② SW_{OUT}
- ③ GND
- ④ Vos
- ⑤ ON/OFF

Plastic Mold Package Type

Flammability: UL94V-0

Weight: Approx. 2.3g

■Block Diagram

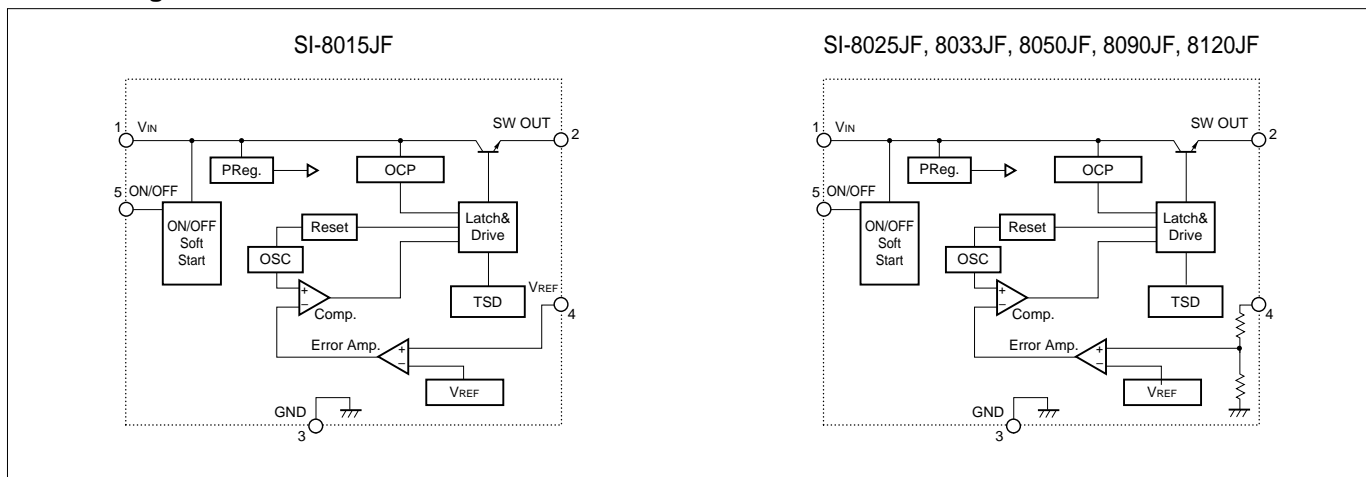

■Standard External Circuit

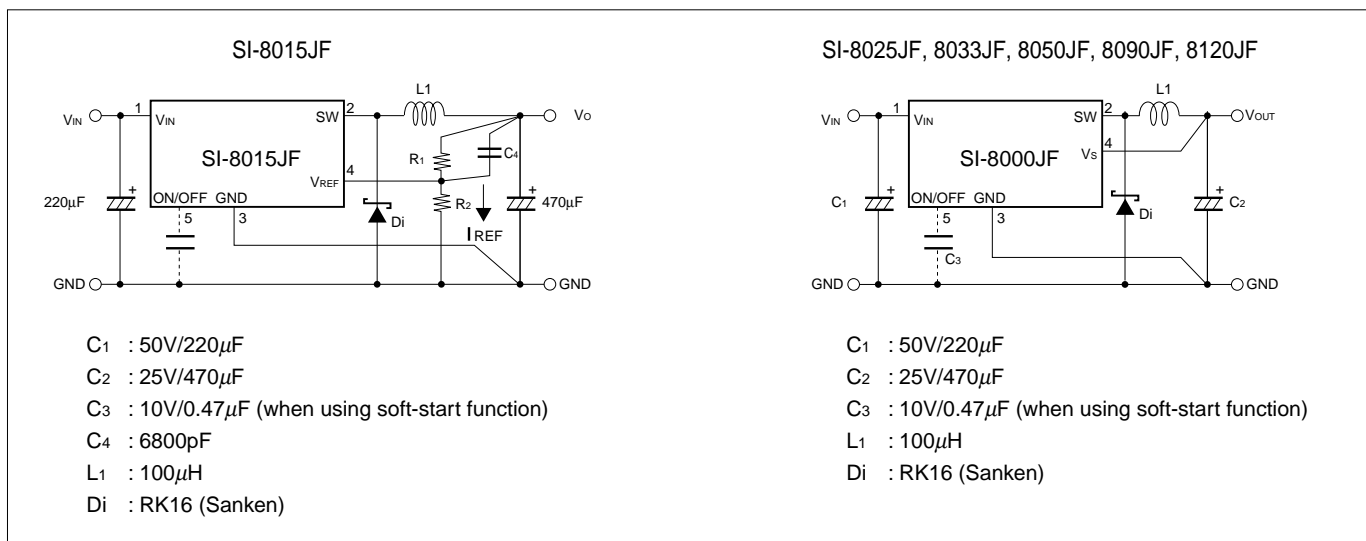

■Example of Pattern on PC Board

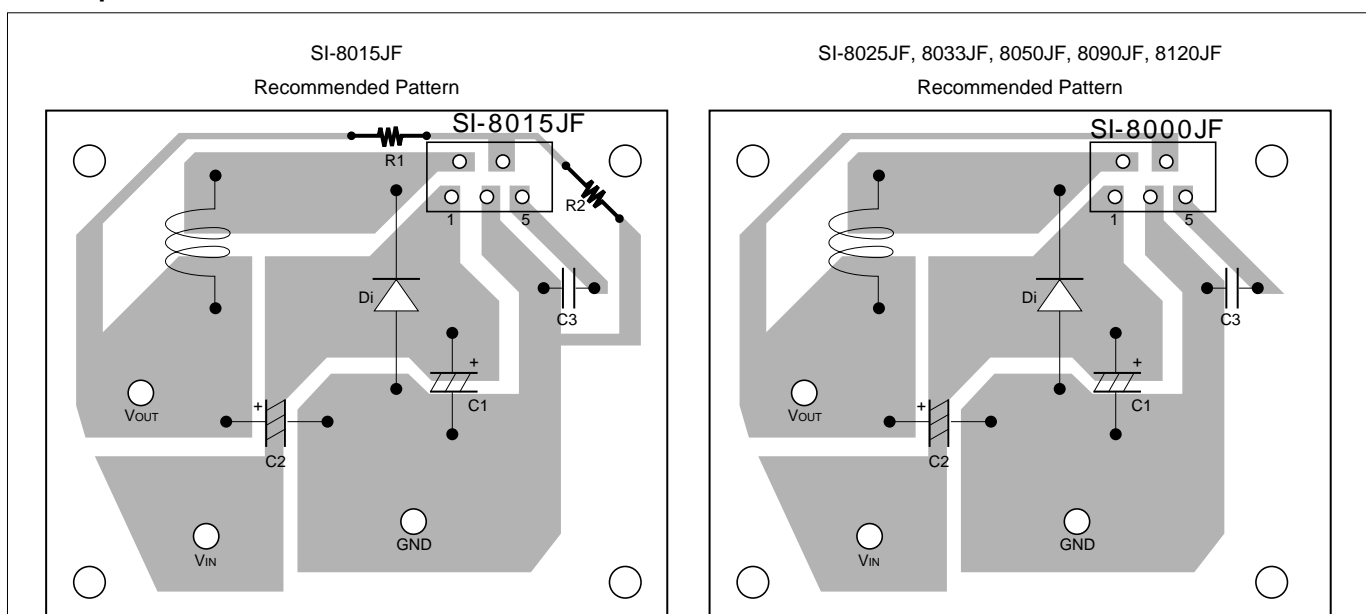

* For the optimum operating conditions, use one-point GND wiring centering on pin 3, and place each component as closely as possible.

Typical characteristics (SI-8015JF) ($V_o=5V$)

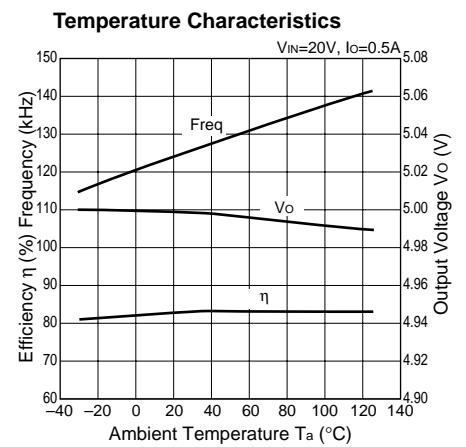
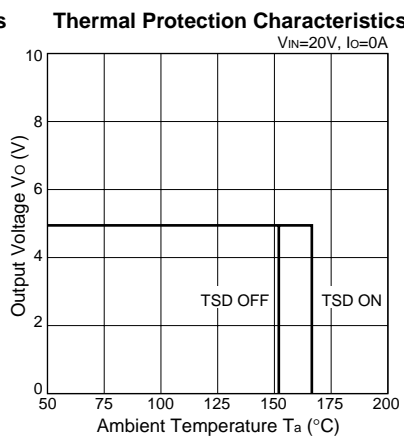
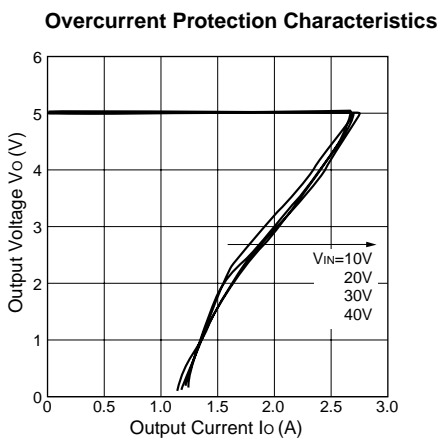
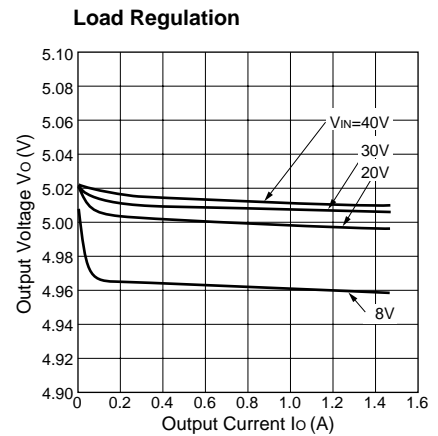
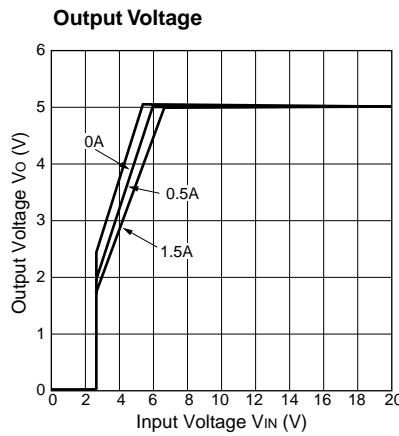
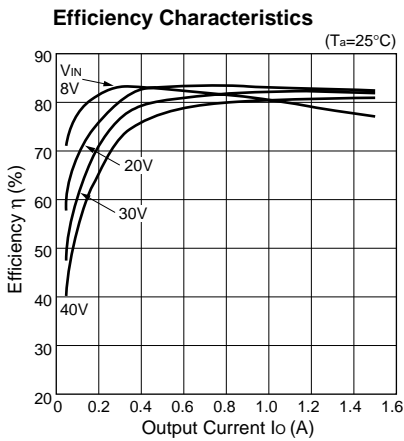

Typical characteristics (SI-8025JF)

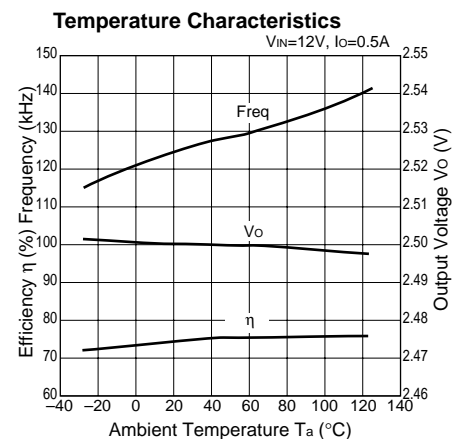
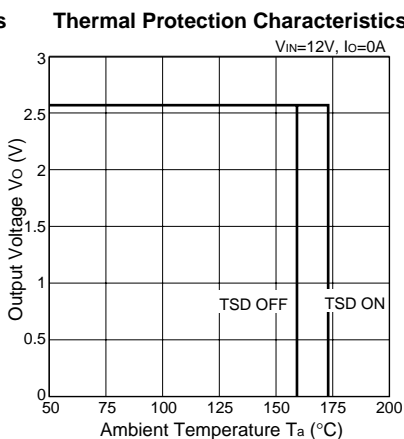
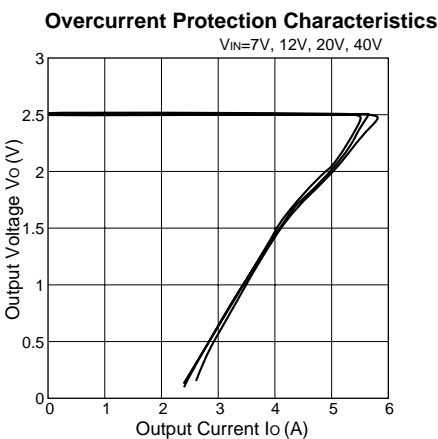
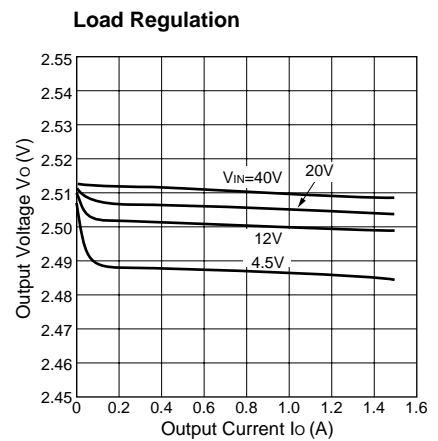
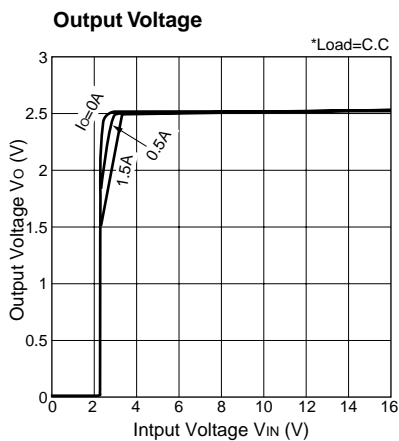
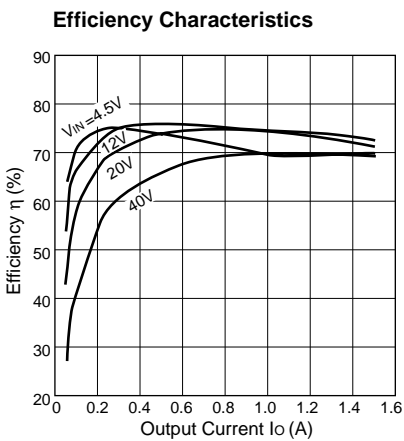

■Typical characteristics (SI-8033JF)

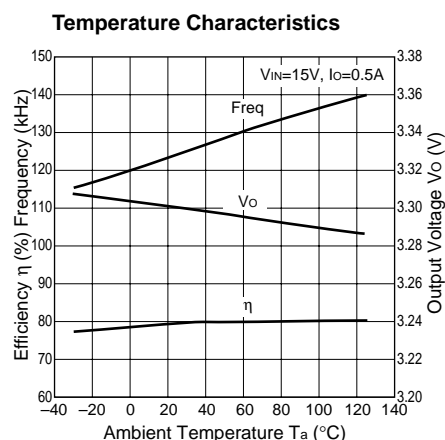
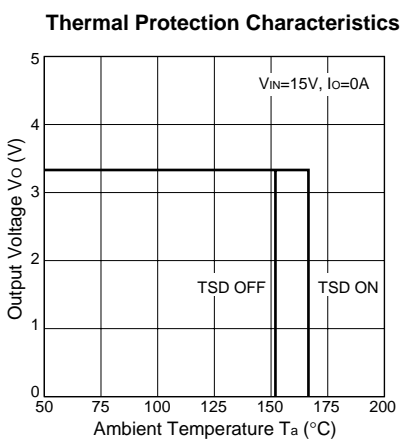
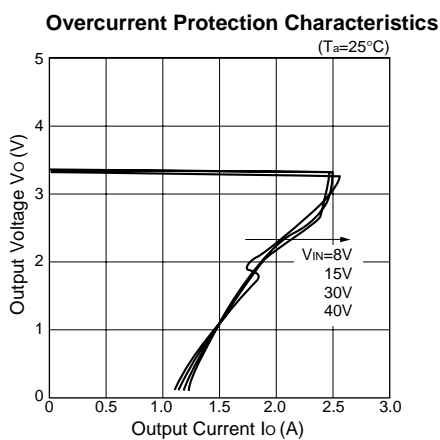
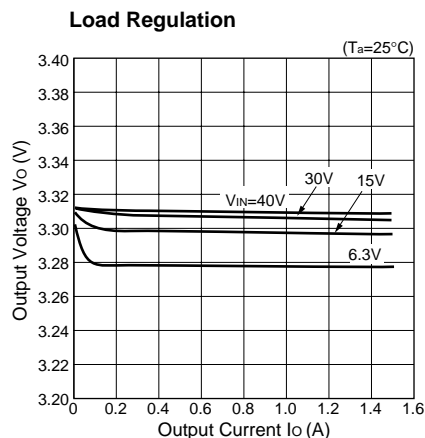
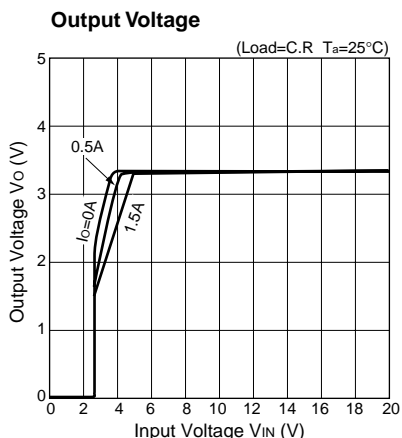
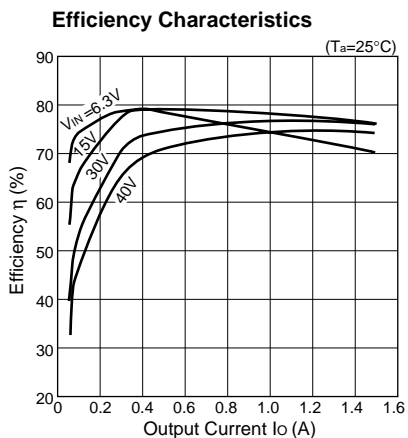

■Typical characteristics (SI-8050JF)

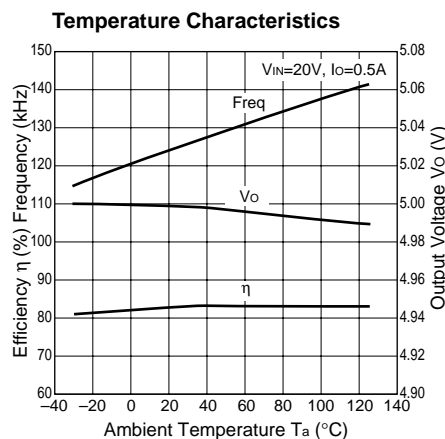
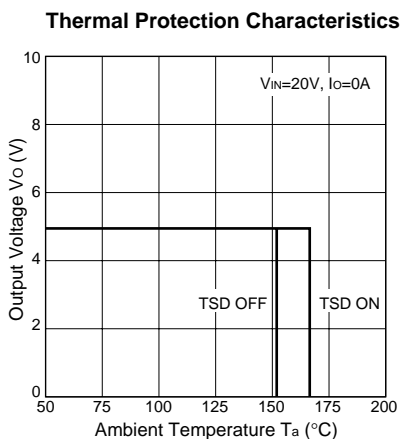
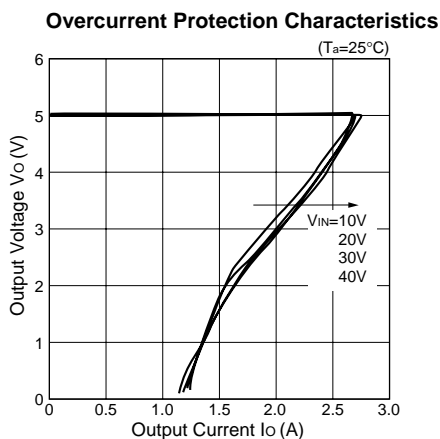
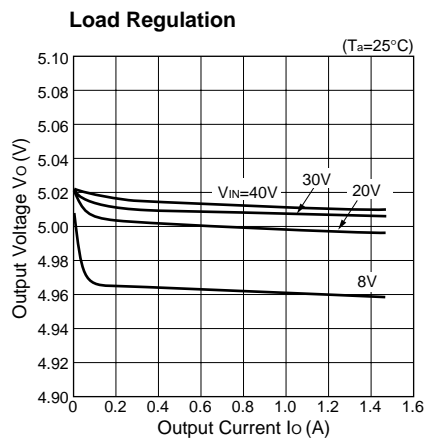
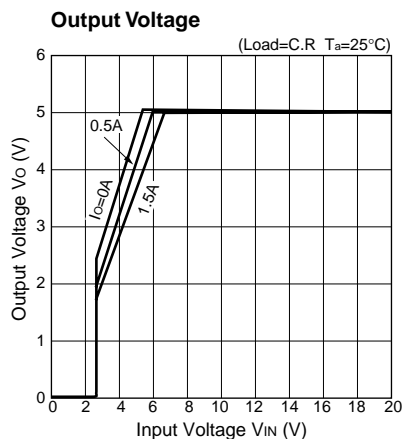
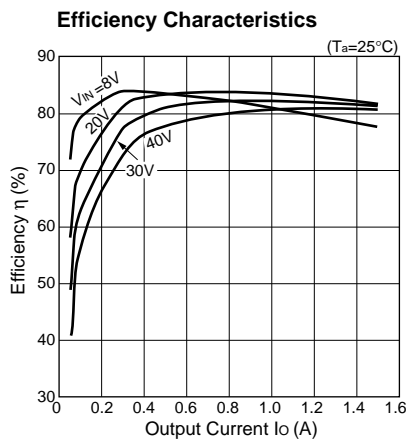

■Typical characteristics (SI-8090JF)

